

User Manual
48W Car Wireless FM Transmitter

EN
DE
RU
FR
ES
JP
AR

Parameters

Brand	JOYROOM
Model	JR-CL16
Name	48W Dual-Microphone Car Wireless FM Transmitter
BT Version	V5.0
Input	DC 12-24V
QC3.0 output	5V⇌3A 9V⇌2A 12V⇌1.5A
PD output	5V⇌3A 9V⇌3A 12V⇌2.5A 15V⇌2A 20V⇌1.5A
PPS	3.3-11V⇌3A, 3.3V-16V⇌2A
Total output	48W
Size	50*45*70mm
Color	Black
Net weight	44g

Packing list

FM transmitter *1, User Manual *1, Warranty Card *1

Product introduction

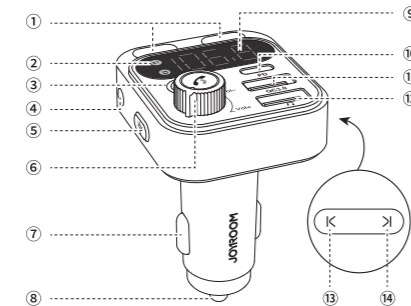

- | | |
|----------------------------|--------------------------|
| ① Dual microphones | ⑧ Positive power contact |
| ② Working status indicator | ⑨ LED display |
| ③ BASS button | ⑩ Type-C charging port |
| ④ AUX port | ⑪ QC3.0 charging port |
| ⑤ Light button | ⑫ USB flash drive port |
| ⑥ Multifunctional button | ⑬ Previous |
| ⑦ Negative power contact | ⑭ Next |

Operation instructions

1. Wireless connection

a. Plug JR-CL16 into the car cigarette lighter socket.

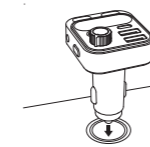

b. Tune the car radio to a blank FM frequency, long press the Knob button, adjust FM transmitter to the Same Frequency with car radio.

Note: Blank frequency refers to frequencies with no vocals or music, just rustling.

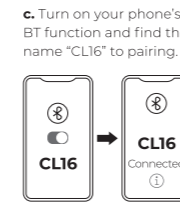

c. Turn on your phone's BT function and find the name "CL16" to pairing.

d. After pairing successfully, you can play music/start phone navigation.

2. USB flash drive connection

a. Plug JR-CL16 into the car cigarette lighter socket.

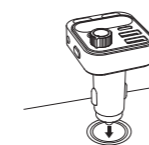

c. Insert USB flash drive into the USB flash drive port. **The QC3.0 port does not support USB flash drive.**



b. Tune the car radio to a blank FM frequency, long press the Knob button, adjust FM transmitter to the Same Frequency with car radio.

Note: Blank frequency refers to frequencies with no vocals or music, just rustling.

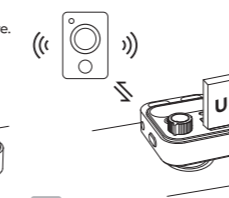

d. After connecting successfully, you can start to play music.

3. AUX connection

a. Plug JR-CL16 into the car cigarette lighter socket.

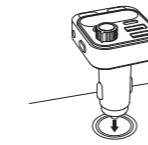

c. Insert the AUX cable into CL16 AUX port and the car AUX port.

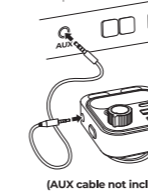

b. Turn on your phone's BT function and find the name "CL16" to pairing.



d. After connecting successfully, you can play music/start phone navigation.

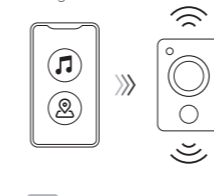



** Frequency adjustment **

Long press the multifunctional button , the LED display will start to flash after 2s; rotate the knob leftward/ rightward to select frequency.





** Volume adjustment **

If you feel the music volume is too low, you can:
1. Volume up your phone;
2. Volume up the FM transmitter by rotating the multifunctional button;
3. Volume up the car audio.

** Answer/reject/end calls **

Answer a call: short press the  button;
End a call: short press the  button during the call;
Reject a call: Long press the  button for 2s.

** Playing music **

Press  button to skip to previous song;
Press  button to skip to next song;
Press multifunctional button  to pause;
Press  again to resume playing.

** Sound effect switch **

Short press , the "b" indicator light on LED display will light up, which means BASS mode is started.

** Wireless/USB flash drive mode switch **

Press and hold  for 2s to switch between wireless/USB flash drive mode.

** Battery voltage detection function **

When the CL16 is inserted into the cigarette lighter, the LED display will indicate the current car voltage. When the car voltage is in an abnormal range, it is recommended to replace the car battery or carry out maintenance;

Car model	Abnormal range	Normal range before start up	Normal range after start up
12V	<11.6V or >14.8V	11.6V-12.8V	11.6V-14.8V
24V	<23.2V or >27.2V	23.2V-25.6V	23.2V-27.2V

Q & A

Q: What is blank frequency?

A: A blank frequency is a non-working frequency which makes rustling current static noise.

Q: Why is there a noise when playing music in the car?

A: Make sure the car radio is turned on and the car radio frequency is consistent with the FM frequency. Besides, you have to adjust it to the local blank frequency when using.

Q: Why can't the phone be charged fast?

A: Check whether your phone supports the charging protocol of the product, and whether the charging cable used supports fast charging.

Q: Why CL16 failed to be connected wirelessly while it can be found on the phone?

A: ① Check whether the phone's BT function is turned on and works normally.
② Check whether the BT indicator is always on. If it is always on, it means that other devices are connected, and you need to disconnect other devices to connect.
4.If the problem still cannot be solved, please delete all the BT names from your phone and reconnect.

Q: Why can't music on the phone be played through the car radio?

A: Check whether the transmitter is connected to the phone's BT, and whether the frequency of the transmitter is the same as that of the car.

Q: Can the song last played be remembered when playing with a USB flash drive?

A: Yes. The product can remember and automatically switch to the song last played.

Q: Can the light of CL16 be turned off?

A: Yes, just short press the light button to turn it off.

Q: Is it safe to charge a phone with CL16?

A: Yes, it's safe as long as you follow the instructions. The product is designed with multiple protections inside.

Cautions:

- Please charge your device after the car engine starts.
- Do not charge high-power devices to prevent device damage caused by excessive power.
- It is normal for the device to emit electromagnetic noise when passing through tunnels or areas with poor signal.
- If the sound is not clear or the connection is unsuccessful when you arrive at the new city, please re-adjust the car FM frequency to the blank frequency, and then reconnect to use;
- Do not use it in wet environment or thunderstorm weather.
- Do not clean it with strong chemicals, cleaning agents, etc.
- Do not drop or throw it violently and please keep it from collision considering this product is an electronic product.

We hope you never have the need, but if you do, our service is friendly and hassle-free.

✉ support@joyroom.com

1. Activate the lifetime warranty for you!

2. If you need help, our solutions will hyper drive to you within 12 hours.

