



➤ DX8210

Omnidirectional Barcode Scanner



Datalogic Automation Srl
Via Lavino, 265
40050 - Monte S. Pietro
Bologna - Italy

DX8210 Omnidirectional Barcode Scanner Reference Manual

Ed.: 8/2016

© 2015-2016 Datalogic S.p.A. and its Group companies ♦ ALL RIGHTS RESERVED. ♦ Protected to the fullest extent under U.S. and international laws. Copying or altering of this document is prohibited without express written consent from Datalogic S.p.A.

Datalogic and the Datalogic logo are registered trademarks of Datalogic S.p.A. in many countries, including the U.S. and the E.U.

PackTrack, ACR, ASTRA and X-PRESS are trademarks of Datalogic S.p.A. or of Datalogic Group companies. All other brand and product names are trademarks of their respective owners.

Datalogic shall not be liable for technical or editorial errors or omissions contained herein, nor for incidental or consequential damages resulting from the use of this material.

29/08/16

CONTENTS

| | |
|--|-------------|
| REFERENCES | vii |
| Reference Documentation | vii |
| Support Through the Website | vii |
| Patents | vii |
| CONVENTIONS..... | viii |
| COMPLIANCE..... | viii |
| Electrical Safety | viii |
| Laser Safety..... | viii |
| Bureau of Indian Standard (BIS) | ix |
| Warning and Serial labels | ix |
| Power Supply..... | x |
| CSA Certified | x |
| CE Compliance | x |
| FCC Compliance..... | xi |
| GENERAL VIEW | xii |
| 1 INTRODUCTION | 1 |
| 1.1 Product Description..... | 1 |
| 1.2 Applications | 1 |
| 1.3 Model Description | 3 |
| 1.4 DX8210 Versions | 3 |
| 1.5 X-PRESS (Human Machine Interface) | 4 |
| 1.6 Accessories | 5 |
| 1.7 Photoelectric Sensor..... | 7 |
| 1.8 Encoder (Tachometer) | 8 |
| 1.8.1 Encoder/Tachometer Step Settings..... | 8 |
| 1.8.2 Photocraft Encoder/Tachometer Switch Setting | 9 |
| 1.9 CBX Industrial Connection Box | 10 |
| 1.10 SC5000 System Controller..... | 11 |
| 2 MECHANICAL INSTALLATION..... | 12 |
| 2.1 Preparing for Mechanical Install | 12 |
| 2.2 Unpacking Instructions..... | 13 |
| 2.3 Installation Sequence..... | 14 |
| 2.4 What You Need to Know About Your Application | 15 |
| 2.5 Mechanical Installation..... | 16 |
| 2.5.1 Dimensions and Clearances | 16 |
| 2.5.2 Physical Support Requirements | 16 |
| 2.5.3 Vibration Limitations..... | 16 |
| 2.5.4 General Mounting Guidelines..... | 17 |
| 2.5.5 Mounting Structure Considerations | 17 |
| 2.5.6 Mounting the Scanner | 18 |
| 3 ELECTRICAL INSTALLATION | 22 |
| 3.1 Preparing for Electrical Installation | 22 |
| 3.2 Connecting a DX8210 Scanner..... | 23 |
| 3.3 Typical Connection Block Diagrams..... | 24 |
| 3.3.1 Single DX8210 Barcode Scanner to CBX..... | 24 |
| 3.3.2 Master/Slave Array with CBX510 | 25 |

| | | |
|----------|--|-----------|
| 3.3.3 | DX8210 Barcode Scanners in an Array with SC5000 Master | 26 |
| 3.4 | General Electrical Installation Guidelines And Precautions | 28 |
| 3.5 | DX8210 Connector Panel | 29 |
| 3.6 | Connecting a PC to the DX8210 | 30 |
| 3.7 | Power Connector Pin-Out Table | 30 |
| 3.8 | Power Connections | 31 |
| 3.9 | CBX510 Connection Box | 32 |
| 3.9.1 | Wiring Into the CBX510 Connection Box | 32 |
| 3.10 | Main Serial Interface | 33 |
| 3.10.1 | RS232 Interface | 33 |
| 3.10.2 | RS422 Full-Duplex Interface | 34 |
| 3.11 | Photoelectric Sensor Connections to CBX510 | 35 |
| 3.11.1 | Photoelectric Sensor (NPN) | 36 |
| 3.11.2 | Photoelectric Sensor (PNP) | 37 |
| 3.12 | Tachometer Wiring to CBX510 or SC5000 Controller | 38 |
| 3.12.1 | Encoder/Tachometer Wiring for NPN Output (two models) | 38 |
| 3.12.2 | Encoder/Tachometer Wiring for PNP Output (two models) | 40 |
| 3.14 | Digital Output Configuration to CBX510 | 42 |
| 3.14.1 | Unpowered Outputs | 42 |
| 3.14.2 | Powered Outputs | 43 |
| 3.15 | Connecting to the SC5000 System Controller (optional) | 44 |
| 3.16 | Grounding | 45 |
| 3.17 | Check Scanner Installation | 46 |
| 4 | E-GENIUS | 47 |
| 4.1 | Getting Started | 47 |
| 4.1.1 | Prerequisites | 47 |
| 4.1.2 | Starting e-Genius | 48 |
| 4.2 | e-Genius Basics | 50 |
| 4.2.1 | e-Genius Menu Tree | 50 |
| 4.2.2 | Entering Text Using the Text Entry Tool | 50 |
| 4.2.3 | Update and Reset Buttons | 51 |
| 4.2.4 | Getting Help | 51 |
| 4.3 | Modify Settings | 53 |
| 4.4 | Modify Settings System Info | 54 |
| 4.5 | Modify Settings Global Settings | 57 |
| 4.5.1 | Modify Settings Global Settings Operating Mode | 58 |
| 4.5.2 | Modify Settings Global Settings Barcode Settings Table | 72 |
| 4.5.3 | Modify Settings Global Settings Barcode Configuration | 77 |
| | Strip Filter Settings | 81 |
| | Strip Filter Settings | 86 |
| | Strip Filter Settings | 103 |
| 4.5.4 | Modify Settings Global Settings Serial Ports | 104 |
| 4.5.5 | Modify Settings Global Settings Ethernet | 108 |
| | User Socket <i>n</i> | 111 |
| 4.5.6 | Modify Settings Global Settings Fieldbus | 119 |
| 4.5.7 | Modify Settings Global Settings Messaging | 124 |
| 4.5.8 | Modify Settings Global Settings Digital I/O | 153 |
| 4.5.9 | Modify Settings Global Settings Diagnostics | 156 |
| 4.5.10 | Modify Settings Global Settings Energy Saving | 158 |
| 4.5.11 | Modify Settings Global Settings HMI Settings (Human-Machine Interface) | 163 |
| 4.6 | Device Settings | 165 |
| 4.6.1 | Device Settings Device Name Device Info | 166 |
| 4.6.2 | Device Settings Device Name Mounting | 168 |
| 4.6.3 | Device Settings Device Name Options | 171 |

| | | |
|----------|---|------------|
| 4.7 | Diagnostics | 174 |
| 4.7.1 | Diagnostics Monitor..... | 175 |
| 4.7.2 | Diagnostics Read Test | 177 |
| 4.7.3 | Diagnostics Status Viewer..... | 178 |
| 4.8 | Utilities | 181 |
| 4.8.1 | Utilities Backup or Restore | 181 |
| 4.8.2 | Utilities Reboot..... | 183 |
| 4.8.3 | Utilities Update Firmware | 184 |
| 4.8.4 | Utilities Help | 186 |
| 5 | BARCODE SCANNING FEATURES..... | 187 |
| 5.1 | First-time Startup | 187 |
| 5.1.1 | Default Parameters | 187 |
| 5.1.2 | Check Operations using Test Mode | 187 |
| 5.2 | Basic Installation Procedures with the CBX510..... | 189 |
| 5.3 | Basic Installation with SC5000 Controller..... | 192 |
| 5.4 | LED Indicators | 196 |
| 5.5 | Control Panel Buttons | 197 |
| 5.5.1 | X-Press™ Human Machine Interface | 197 |
| | X-PRESS Functions..... | 197 |
| | Test Mode..... | 199 |
| | Learn | 199 |
| | Setup | 199 |
| | Netconfig..... | 200 |
| 5.5.2 | Restore Button and Other Functions | 200 |
| 5.6 | Built-In Calibration for Top-Mount..... | 201 |
| 5.6.1 | Built-In Calibration Static Test | 206 |
| 5.6.2 | Built-In Calibration Dynamic Test | 207 |
| 5.7 | PackTrack™ | 209 |
| 5.7.1 | Using the PackTrack Wizard | 210 |
| 5.7.2 | Top-Mounted Barcode Scanner Calibration Using PackTrack..... | 214 |
| 5.7.3 | Side-Mounted Barcode Scanner Calibration Using PackTrack..... | 227 |
| 5.7.4 | Verifying PackTrack Calibration | 239 |
| 5.8 | Replacing an Installed DX8210 | 241 |
| 5.8.1 | Replacing a Standalone Scanner Using Restore..... | 241 |
| 5.8.2 | Replacing a Slave Scanner in an Array/Tunnel Automatically | 242 |
| 5.8.3 | Replacing a Slave Scanner in an Array/Tunnel Using Restore..... | 243 |
| 5.8.4 | Replacing a Master Scanner in an Array/Tunnel Using Restore | 243 |
| 5.8.5 | Checking the Operation of the Replacement..... | 244 |
| 5.9 | Typical Layouts | 245 |
| 5.9.1 | Large Synchronized Network Layout..... | 245 |
| 5.10 | Advanced Code Reconstruction (ACR™)..... | 249 |
| 5.10.1 | Tilt Angle for Advanced Code Reconstruction | 249 |
| 5.10.2 | Minimum Code Height for Advanced Code Reconstruction | 251 |
| 5.11 | Reading Diagrams | 253 |
| 6 | MAINTENANCE | 262 |
| 6.1 | Overview..... | 262 |
| 6.2 | Maintenance Tasks..... | 263 |
| 6.2.1 | Cleaning the Exit Window | 264 |
| 6.2.2 | Cleaning the Photoelectric Sensor | 265 |
| 6.2.3 | Cleaning the Tachometer/Encoder..... | 266 |
| 6.2.4 | Tighten Mounting Hardware | 267 |
| 6.2.5 | Checking Barcode Scanning System Connections..... | 267 |
| 6.2.6 | Verify Barcode Scanner Operation..... | 267 |

| | | |
|----------|---|------------|
| 6.2.7 | Verify Photoelectric Sensor Operation | 267 |
| 6.2.8 | Verify Tachometer/Encoder Operation | 268 |
| 7 | TROUBLESHOOTING..... | 269 |
| 7.1 | LED Diagnostic Indication | 270 |
| 7.2 | Error Codes and Resolutions | 271 |
| 8 | TECHNICAL FEATURES | 277 |
| 8.1 | Technical Specifications..... | 277 |
| | GLOSSARY..... | 280 |
| | INDEX..... | 283 |

REFERENCES

REFERENCE DOCUMENTATION

The documentation related to the DX8210 management is listed below:

- CBX510 Connection Box Installation Manuals
- SC5000 Controller Manuals

SUPPORT THROUGH THE WEBSITE

Datalogic provides several services as well as technical support through its website. Log on to www.datalogic.com and click on **PRODUCTS** and **SUPPORT & SERVICES** links for further information:

- **PRODUCTS – FIXED INDUSTRIAL BARCODE READERS**

Select your product from the links on the **Fixed Industrial Barcode Readers** page. The product page describes specific Info, Features, Applications, Models, Accessories, and Downloads including documentation, software drivers, and utility programs.

- **SUPPORT & SERVICES – INDUSTRIAL AUTOMATION**

Several links from the **Industrial Automation** list take you to additional services such as: Service Program which contains Maintenance Agreements and Warranty Extensions; Repair Centers; On-Line RMA Return Material Authorizations; Technical Support through email or phone; Downloads for additional downloads.

PATENTS

See www.patents.datalogic.com for patent list.

This product is covered by one or more of the following patents:

Utility patents: EP0789315B1; EP0851376B1; EP0959426B9; EP1217571B1;
EP1363228B1; JP4033958B2; JP4376353B2; US5979761; US5992740; US6347740;
US6394352; US6443360; US6629639; US6742710; US9104928

CONVENTIONS



WARNINGS OR CAUTIONS: This symbol identifies a hazard or procedure that, if incorrectly performed, could cause personal injury or result in equipment damage. It is also used to bring the user's attention to details that are considered IMPORTANT.



HIGH VOLTAGE CAUTION: This symbol alerts the user they are about to perform an action involving, either a dangerous level of voltage, or to warn against an action that could result in damage to devices or electrical shock.



LASER CAUTION: This symbol alerts the user they are about to perform an action involving possible exposure to laser light radiation.



ESD CAUTION: This symbol identifies a procedure that requires you take measures to prevent Electrostatic Discharge (ESD) e.g., use an ESD wrist strap. Circuit boards are most at risk. Please follow ESD procedures.



NOTES: This symbol draws attention to details or procedures that may be useful in improving, maintaining, or enhancing the performance of the hardware or software being discussed.

COMPLIANCE

ELECTRICAL SAFETY

This product conforms to the applicable requirements contained in the European Standard for electrical safety EN 60950 at the date of manufacture.

LASER SAFETY

The following information is provided to comply with the rules imposed by international authorities and refers to the correct use of the DX8210 barcode scanners.

Standard Regulations

These barcode scanners use low-power laser diodes. Avoid staring at the beam as one would with any very strong light source, such as the sun.

Take care when installing the laser device to avoid inadvertent laser beam contact with the eye of an observer, including through reflective surfaces.

This product conforms to the applicable requirements of IEC 60825-1 and complies with 21 CFR 1040.10 except for deviations pursuant to Laser Notice N° 50, date June 24, 2007. The scanner is classified as a Class 2 laser product according to IEC 60825-1 regulations.

There is a safety device which allows the laser to be switched on only if the motor is rotating above the threshold for its correct scanning speed.



WARNING: Use of controls or adjustments or performance of procedures other than those specified herein may result in exposure to hazardous visible laser light.

BUREAU OF INDIAN STANDARD (BIS)

Self Declaration – Conforming to IS 13252 (Part 1):2010, R-41009288.

WARNING AND SERIAL LABELS

The Warning Label on the barcode scanner indicates exposure to laser light and the device classification.



Figure 1: Warranty, Device Class, and Warning Label Location

Produit(s) conforme selon 21CFR 1040.10 sauf des dérogations relatives à la Laser Notice N° 50, date Juin 24, 2007.

Dans le paquet il y a l'étiquette(s) pour les pays où le texte d'avertissement en français sont obligatoires. Le(s) mettre sur le produit à la place de la version anglaise.



Figure 2: Exemple d'étiquettes d'avertissement laser



WARNING: Disconnect the power supply when installing the device or during maintenance to avoid unintentional exposure to laser light.



WARNING: There are no user serviceable parts inside the barcode scanner. Service should only be performed by Datalogic trained and certified technicians.

Any violation of the optical parts in particular could result in exposure to Class 3B laser light.

POWER SUPPLY

This product is intended to be installed by Qualified Personnel only.

This product is intended to be supplied by a UL listed or CSA Certified Power unit with “Class 2” or LPS power source.

CSA CERTIFIED



CE COMPLIANCE

CE marking states the compliance of the product with essential requirements listed in the applicable European directive. Since the directives and applicable standards are subject to continuous updates, and since Datalogic promptly adopts these updates, therefore the EU declaration of conformity is a living document. The EU declaration of conformity is available for competent authorities and customers through Datalogic commercial reference contacts. Since April 20th, 2016 the main European directives applicable to Datalogic products require inclusion of an adequate analysis and assessment of the risk(s). This evaluation was carried out in relation to the applicable points of the standards listed in the Declaration of Conformity. Datalogic Automation products are mainly designed for integration purposes into more complex systems. For this reason it is under the responsibility of the system integrator to do a new risk assessment regarding the final installation.



WARNING: This is a Class A product. In a domestic environment this product may cause radio interference in which case the user may be required to take adequate measures.

FCC COMPLIANCE



Modifications or changes to this equipment without the expressed written approval of Datalogic could void the authority to use the equipment.

This device complies with PART 15 of the FCC Rules. Operation is subject to the following two conditions: (1) This device may not cause harmful interference, and (2) this device must accept any interference received, including interference which may cause undesired operation.

This equipment has been tested and found to comply with the limits for a Class A digital device, pursuant to part 15 of the FCC Rules. These limits are designed to provide reasonable protection against harmful interference when the equipment is operated in a commercial environment. This equipment generates, uses, and can radiate radio frequency energy and, if not installed and used in accordance with the instruction manual, may cause harmful interference to radio communications. Operation of this equipment in a residential area is likely to cause harmful interference in which case the user will be required to correct the interference at his/her own expense.

GENERAL VIEW



Figure 3: DX8210 Barcode Scanner Front and Left Side Views

1 INTRODUCTION

1.1 PRODUCT DESCRIPTION

The DX8210 omnidirectional barcode scanner is designed to provide an innovative and high performance solution in omnidirectional reading applications by combining the following advanced technologies with Datalogic solid experience in the material handling sector.

Some of the main features of the DX8210 are listed below:

- Scanning speed 1000 scans/sec
- Reads all popular codes
- Supply voltage from 20 to 30 vdc
- Test mode to verify the reading features and exact positioning of the scanner without the need for external tools
- Programmable in several different operating modes to suit the most various barcode reading system requirements
- Light source: solid state laser diodes; the light emitted has a wave length between 630~680 nm. For laser safety precautions refer to the “compliance” section at the beginning of this manual

1.2 APPLICATIONS

The DX8210 omnidirectional barcode scanners are specifically designed for industrial applications and for all cases requiring high reading performance such as:

- Code reconstruction (ACR™)
- Reading of codes covered by plastic film
- Reading of codes with a wide depth of field
- Reading codes within a wide field of view
- Reading of high resolution codes positioned at long distances from the reader
- Code reading on fast moving objects

These barcode scanners are designed for both single-reader layouts and multi-reader layouts. For typical layouts, see *section 5.9*.

| Feature | Benefit |
|------------------------------|---|
| DST | Digital Signal Technology converts analog signals to digital before processing for much improved decoding capability especially on poorly printed or damaged codes. |
| ACR™ | Fifth generation Advanced Code Reconstruction technology allows the reading of low aspect ratio labels placed anywhere on a parcel and enhances the readability of poorly printed or damaged codes. |
| PACKTRACK™ | Second generation Datalogic patented parcel tracking system which improves the reading features in omnidirectional stations. In particular, PackTrack manages 6-sided reading systems when it is impossible to detect the real position of the code on the parcel, thus overcoming the need for external accessories essential in traditional tracking systems. |
| ASTRA™ | Third generation Automatically SwiTched Reading Area is the Datalogic technology based on a multi-laser architecture and a fixed mounted optic system which concentrates the multiple laser emissions in a single laser beam. As each laser emitter is focused on a specific range of the reading area, a sophisticated electronic controller selects the best focused laser emitter with respect to the code to read. This allows the reading of medium-high density codes in a large reading area on very fast conveyors. |
| Flexibility | The high frequency laser diode modulation system guarantees complete immunity to ambient light and allows installation of the DS8110 in any working area. |
| Reading parcels on conveyors | As a result of the ASTRA multiple laser technology, DX8210 and DS8110 give a great real time DOF even on high speed conveyors. Furthermore, DX8210 and DS8110 implement the PackTrack functionality which leads to an increase of the plant production as a result of the augmented system throughput. |
| EBC | Ethernet Based Connectivity is a reliable real-time network communication between scanners in a reading station tunnel or array. |
| e-Genius | e-Genius is a browser-based User Interface with the following characteristics: No software to install; Multilanguage platform; All the configuration parameters stored in the scanner; Not dependent on the Physical interface; Remote access through local network. |
| Energy Saving | A software parameter group which allows management of the energy saving feature. In particular, it allows turning on/off the motor and laser of all network scanners according to the selected digital input, encoder, or communication channel. The time required to restart the system is less than 1 minute independently from the number of scanners connected. It is suggested to use this parameter for example when the conveyor is stopped for a lengthy period. |

1.3 MODEL DESCRIPTION

The DX8210 barcode scanner is available in versions that differ depending on the interface connection, the optical resolution and on the optic version:

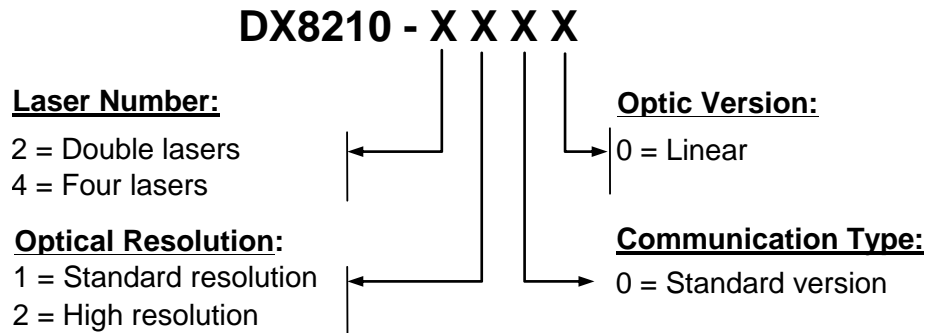

Figure 4: Model Description Key

1.4 DX8210 VERSIONS

| Model | Description | Part Number |
|-----------------------|------------------------------|-------------|
| DX8210-2100 | 2 Laser, Standard Resolution | 936300001 |
| DX8210-4100 (focus 1) | 4 Laser, Standard Resolution | 936300003 |
| DX8210-4200 (focus 2) | 4 Laser, High Resolution | 936300004 |

1.5 X-PRESS (HUMAN MACHINE INTERFACE)

The DX8210 barcode scanner includes two external buttons that make up the X-PRESS HMI interface and perform specific tasks without the need of connecting to **e-Genius**. See *section 5.5* for functional description.



Figure 5: DX8210 X-PRESS Interface Buttons



NOTE: Some of these functions may be performed using **e-Genius**. See *Chapter 4*.

1.6 ACCESSORIES

The following accessories are available on request for the DX8210 barcode scanner.

| Category | Description | Part Number |
|-------------------------------|---|-------------|
| Cables and Terminators | | |
| Ethernet Cables | ETH CABLE M12-M12 1M (straight-straight) Scanner to Scanner EBC (ETH1 or ETH2) | 93A050065 |
| | ETH CABLE M12-M12 3M (straight-straight) Scanner to Scanner EBC (ETH1 or ETH2) | 93A050066 |
| | ETH CABLE M12-M12 5M (straight-straight) Scanner to Scanner EBC (ETH1 or ETH2) | 93A050067 |
| | ETH CABLE M12-M12 1M (straight- 90°) SC5000 to Scanner EBC (ETH1 or ETH2) | 93A050068 |
| | ETH CABLE M12-M12 3M (straight- 90°) SC5000 to Scanner EBC (ETH1 or ETH2) | 93A050069 |
| | ETH CABLE M12-M12 5M (straight- 90°) SC5000 to Scanner EBC (ETH1 or ETH2) | 93A050070 |
| | ETH CABLE M12-RJ45 5M (90°-RJ45) SC5000 to the Host or Configuration PC (HOST or CFG) | 93A050088 |
| | CAB-ETH-M01 M12-IP67 1M (straight- RJ45) Scanner to the Host or Configuration PC | 93A051346 |
| | CAB-ETH-M03 M12-IP67 3M (straight- RJ45) Scanner to the Host or Configuration PC | 93A051347 |
| | CAB-ETH-M05 M12-IP67 5M (straight- RJ45) Scanner to the Host or Configuration PC | 93A051348 |
| REDs Cables | ETH CABLE M12-M12 1M (90°- 90°) SC5000 to SC5000 EBC (ETH1 or ETH2) | 93A050087 |
| | REDS POWER ALARM CABLE 5M PWR-480B to CBX510 power alarm connections | 93A050086 |
| EBC Patch Cable | ETH CABLE M12-M12 0.5M (straight-straight) Female to Female EBC patch cable; close the EBC when a scanner is sent to repair, only for Master/Slave | 93A050085 |
| Interface Cable | SC5000 to CBX510 for Serial or I/O connections | 93A050071 |
| CBX Cables | CAB-DS01-S M12-IP67 1M Scanner to CBX for Serial or I/O connections | 93A050058 |
| | CAB-DS03-S M12-IP67 3M Scanner to CBX for Serial or I/O connections | 93A050059 |
| | CAB-DS05-S M12-IP67 5M Scanner to CBX for Serial or I/O connections | 93A050060 |
| AS-I Terminal | AS-I CABLE TERMINAL for AS-I branch topology wiring | 93ACC0083 |
| Power Cables | PWR CABLE, AS-I, 2 Wires, 10M (Backbone with caps) | 93ACC0081 |
| | PWR CABLE, AS-I, 2 Wires, 25M (Backbone with caps) | 93ACC0082 |
| | PWR CABLE M12- ASI standard 1M (Node) | 93ACC0067 |
| | PWR CABLE M12- ASI standard 2M (Node) | 93ACC0068 |
| | PWR CABLE ext. M12 Male-M12 Fem 3M for PG-240 | 93ACC0149 |
| | PWR CABLE ext. M12 Male-M12 Fem 5M for PG-240 | 93ACC0150 |
| | PWR CABLE, CAB-LP-05 M12 Female-Free Wires 5M for alternative power connections | 93A050037 |
| Connection Boxes | | |
| | CBX100 Compact | 93A301067 |
| | CBX100 Compact All in One (includes BM100) | 93A301076 |
| | CBX510 Modular | 93A301087 |
| | CBX510 Modular All in One (includes BM100) + BA200 | 93A301091 |
| Backup Module | BM100 Backup Module | 93ACC1808 |
| Mounting Hardware | BA200 Mounting Adapters (to Bosch or 80/20 Frames) | 93ACC1822 |
| Fieldbus Modules | BM300/310 Profibus Module STD/IP65 | 93ACC1810, |
| | | 93ACC1811 |

| Category | Description | Part Number |
|--------------------------|--|-------------------------|
| Fieldbus Modules | BM700/710 Profinet Module STD/IP65 | 93ACC1816, 93ACC1886 |
| Controllers | | |
| | SC5000-1000 Standard System Controller | 935750001 |
| | SC5000-1100 Profibus System Controller | 935750002 |
| | SC5000-1200 Profinet System Controller | 935750003 |
| Mounting Hardware | BA200 Mounting Adapters (to Bosch or 80/20 Frames) | 93ACC1822 |
| Power Supplies | | |
| | PG-100-K03 POWER SUPPLY 60W KIT (US) w/ M12 cable | 93ACC0058 |
| | PG-100-K01 POWER SUPPLY 60W KIT (EU) w/ M12 cable | 93ACC0059 |
| | PG-100-K02 POWER SUPPLY 60W KIT (UK) w/ M12 cable | 93ACC0060 |
| | PG-240-K03 POWER SUPPLY 240W 8 Port M12 (US) w/o M12 Cable | 93ACC0144 |
| | PG-240-K01 POWER SUPPLY 240W 8 Port M12 (EU) w/o M12 Cable | 93ACC0145 |
| | PWR-480B POWER UNIT 110/230VAC 24V | 93ACC0076 |
| Sensors | | |
| | MEP-593 PHOTOCCELL KIT PNP (PH-1) with Free Wires | 93ACC1791 |
| | MEP-604 PHOTOCCELL KIT PNP M12-M12 Photocell with M12 connector for SC5000 | 93ACC0140 |
| Encoders | | |
| | OEK-2 OPTICAL ENCODER KIT (CAB 10M +SPRING) | 93ACC1770 |
| | OEK-4 ENC KIT PNP 250PPR + M12-M12 CABLE | 95B082040 |
| | OEK-4 ENC KIT PNP 250PPR + M12-FREE CABLE | 95B082050 |
| Field Mount Connectors | FMC-5000 2xM12 TRIG+ENC INPUT KIT Connectors for PLC signal to SC5000 (Tilt-Tray or Cross-Belt applications) | 93ACC0181 |
| Mounting Brackets | | |
| L-Bracket | L-Bracket | L-Bracket |
| L-Bracket | L-Bracket | L-Bracket |

1.7 PHOTOELECTRIC SENSOR

The optional Datalogic Photoelectric Sensor is used in DX8210 barcode scanner systems to detect the presence of an item in the scanning area.

The photoelectric sensor is used in singulated systems where the packages are separated by an open space between the trailing edge of one package and the leading edge of the next. The photoelectric sensor, along with the encoder, enables a programmable transmit point at a defined distance from the sensor. Without the photoelectric sensor, the barcode scanner can be run in continuous mode. See **4.5.1 Modify Settings | Global Settings | Operating Mode**.

Depending on the application, these devices may need to be configured differently. While the photoelectric sensor and tachometer work well with belt conveyors, a special configuration is needed for tilt-tray and cross-belt sorter applications. See *section 3.11 for wiring options*.



Figure 6: Photoelectric Sensors

Photoelectric Sensor and Cable (recommended)

| | | |
|------------------------|---|-----------|
| MEP-593 PHOTOCCELL KIT | PNP (PH-1) with Stripped Wires | 93ACC1791 |
| MEP-604 PHOTOCCELL KIT | PNP M12-M12 Photocell with M12 connector for SC5000 | 93ACC0140 |

1.8 ENCODER (TACHOMETER)

The tachometer provides a continuous pulse to the system, which provides feedback on conveyor speed and transmit point, and can be used to help track the package position along the length of the conveyor. See section 3.12 for wiring options.

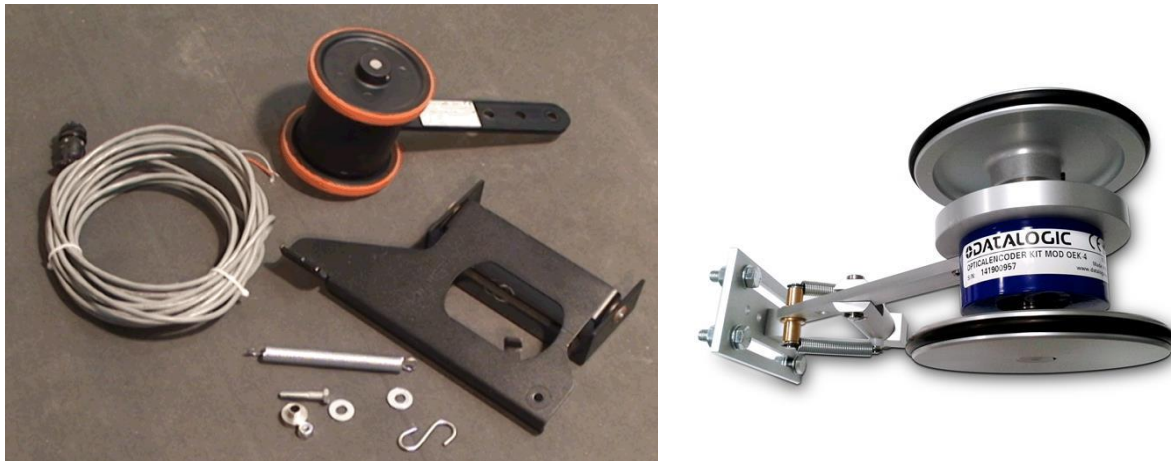

Figure 7: Encoder/Tachometer, Mounting Bracket, and Cable

Encoder (Tachometer)

| | | |
|-----------------|---|-----------|
| OEK-2 ENCOD KIT | OEK-2 ENC KIT (CAB 10m +SPRING) | 93ACC1770 |
| OEK-4 ENCOD KIT | OEK-4 ENC KIT PNP 250PPR + M12-M12 CABLE | 95B082040 |
| OEK-4 ENCOD KIT | OEK-4 ENC KIT PNP 250PPR + M12-FREE CABLE | 95B082050 |

1.8.1 Encoder/Tachometer Step Settings

The following table shows the **Encoder Step** setting used based on pulses per revolution. The Encoder Step setting is entered in **e-Genius** (see section 4.5.1 **Modify Settings | Global Settings | Operating Mode – Encoder Step (hundredths of millimeter)**)

| Encoder Model | PPR (Pulses Per Revolution) | PPI (Pulses Per Inch) | Encoder Step Setting |
|--------------------|--------------------------------|--------------------------|----------------------|
| OEK-4 (Datalogic) | 250 | 20 | 63 |
| OEK-2 (Photocraft) | 24 | 2 | 635 |
| OEK-2 | 48 | 4 | 317 |
| OEK-2 | 192 | 16 | 79 |
| OEK-2 | 240 | 20 | 63 |



NOTE: The maximum allowed encoder frequency is 5 kHz (equivalent to an encoder set to 20 PPI with a conveyor speed of 381 m [1250 ft.] /minute.

1.8.2 Photocraft Encoder/Tachometer Switch Setting

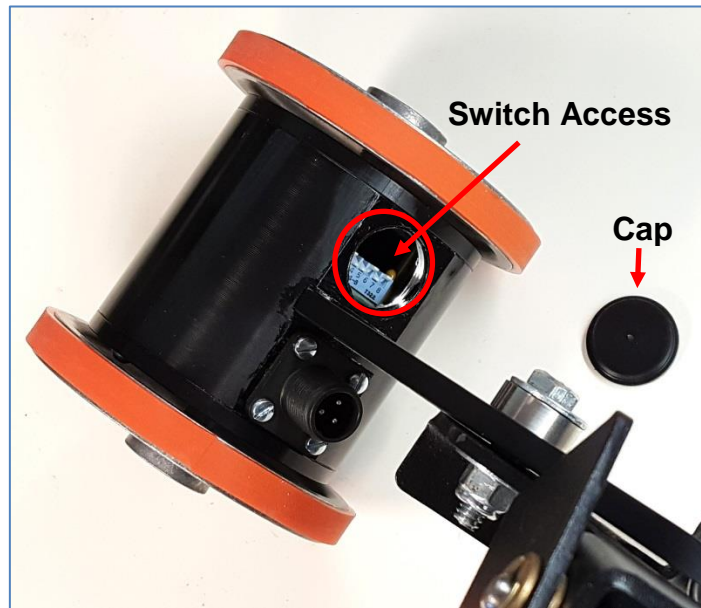
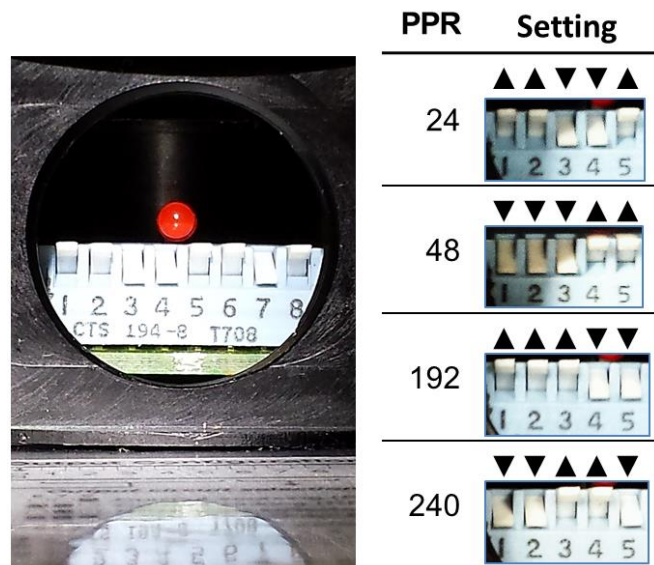

Figure 8: Photocraft (OEK-2) Encoder/Tachometer Switch Location



NOTE: Only switches 1-5 are used to set the PPR (Pulses Per Revolution). Switches 6-8 are used for PNP/NPN settings as shown in the label on the arm of the encoder.

Figure 9: Photocraft (OEK-2) Encoder/Tachometer Switch Settings

1.9 CBX INDUSTRIAL CONNECTION BOX

CBX Series are industrial connection boxes that can be used to connect the barcode scanners to an encoder/tachometer, photoelectric sensor, serial devices, relays, or other peripherals. The CBX510 includes a BM100 backup module, which allows easy parameter restore and backup operations. The backup module also provides an easy way to upload existing parameters to a replacement barcode scanner when necessary. See *section 3.9 for wiring options*.



Figure 10: CBX510 Connection Box



NOTE: Scanner operation requires a CBX510 connection box or SC5000 controller.

Industrial Connection Box

| | | |
|-----------------------|------------------------------|-----------|
| CBX510 Connection Box | CBX510 for DS8110 and DX8210 | 93A301087 |
| CBX510 Connection Box | CBX510 ALL IN ONE + BA200 | 93A301091 |

1.10 SC5000 SYSTEM CONTROLLER

The SC5000 Controller offers all the necessary functions to make the phases of installation, setup, testing, and maintenance of the omni-directional reading array or tunnel easy and quick.

The SC5000 Controller is fully compatible with DS8110 and DX8210 scanners and its sturdy mechanical structure makes the SC5000 Controller the ideal solution for industrial environments. The Controller allows connection to the Trigger and Encoder/Tachometer. PNP inputs are available via M12 circular connectors, placed on the lower front panel (see section 3.15). NPN can be wired directly to the internal terminal block (see section 3.9).

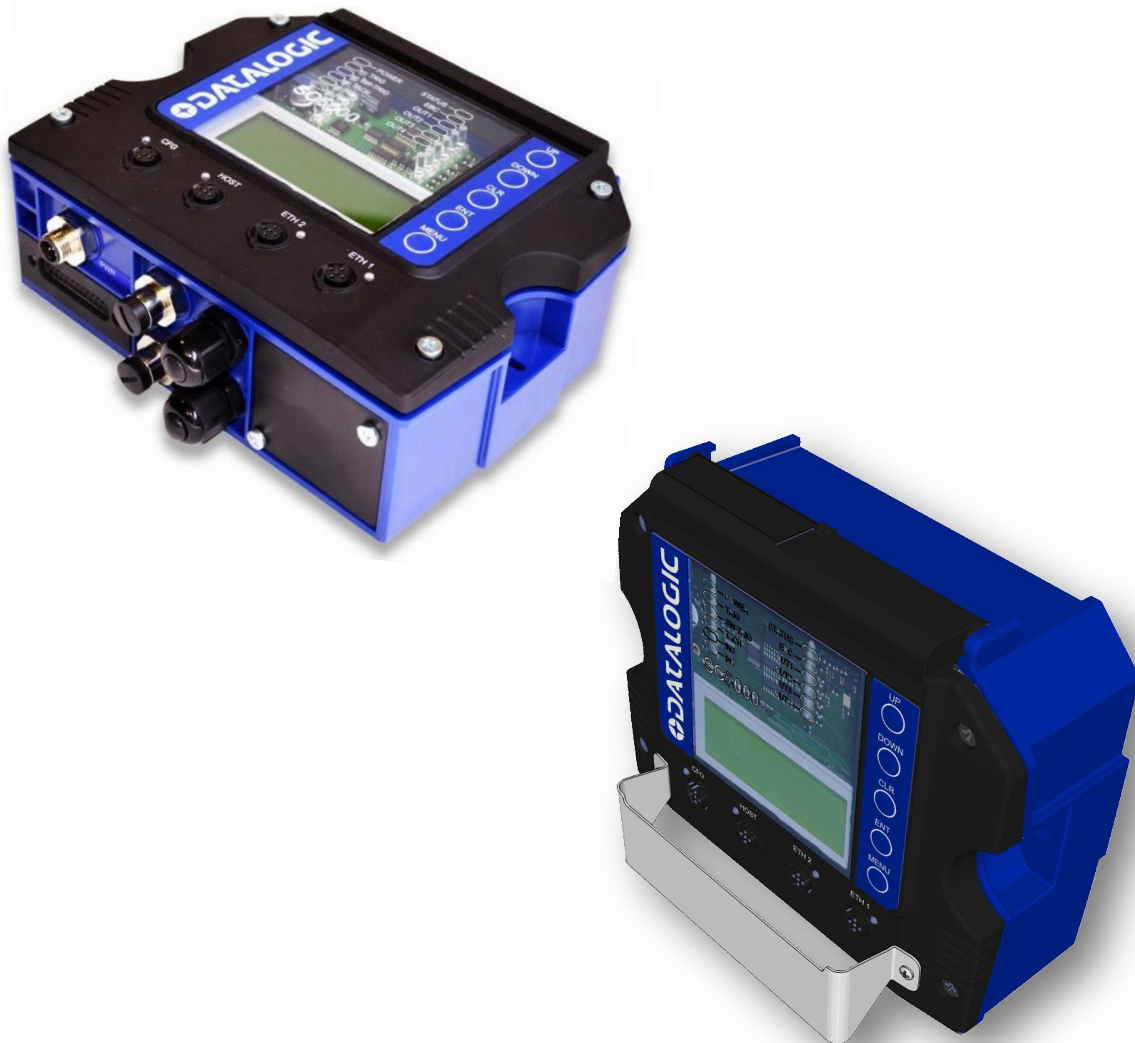

Figure 11: SC5000 System Controller

System Controller

| | | |
|-------------------------------|----------|-----------|
| SC5000-1000 System Controller | Standard | 935750001 |
| SC5000-1100 System Controller | Profibus | 935750002 |
| SC5000-1200 System Controller | Profinet | 935750003 |

2 MECHANICAL INSTALLATION



WARNING: Electrical Installation by Qualified Service Technicians Only! Procedures may involve exposure to high-voltage. A trained and authorized technician must perform these procedures. Do not attempt to perform any electrical installation procedures unless you are a trained technician.



IMPORTANT: DX8210 barcode scanners contain electronics that may be affected by electrostatic discharge (ESD). To prevent personal injury or damage to the unit, please follow the safety precautions and warnings found in the References section at the beginning of this manual. Failure to follow these precautions may void your warranty.

2.1 PREPARING FOR MECHANICAL INSTALL



IMPORTANT: Application-specific drawings and documents provided by Datalogic supersede any contradictory content in this manual.

Before mounting any components, please do the following:

- Read all instructions before beginning your installation.
- Define and confirm the accuracy of your application's requirements and structure position, especially the height of the conveyor from the floor.
- Review all installation-specific drawings provided with your equipment.
- Review and plan the mechanical installation of all devices used in your application. Be sure to allow adequate clearance for maintenance.
- Review and plan the power requirements for your application.
- Check the contents of the shipping cartons against the packing list.
- Record all product serial numbers.



NOTE: Refer to the **Chapter 3 Electrical Installation** and Reference Documentation for details on connecting your barcode scanners to other devices in the system.



WARNING: When installing several scanners, take care to position them so that no laser beam enters the reading window of other scanners. This condition could occur more frequently for side mounted applications. If these precautions are not followed, read rate could be negatively affected. To resolve this problem, it is sufficient to slightly change the inclination and position of one of the two scanners involved.

2.2 UNPACKING INSTRUCTIONS

Verify that the DX8210 barcode scanners and all the parts supplied with the equipment are present and intact when opening the packaging; the list of parts includes:

- DX8210 barcode scanner
- L-Bracket
- Mounting screws and washers
- Shoulder screw (see *Figure 15: Keyhole mounting with large L-Bracket*)
- Barcode Test Chart



Figure 12: Package contents

2.3 INSTALLATION SEQUENCE



NOTE: Everything should be MECHANICALLY INSTALLED before performing any ELECTRICAL INSTALLATION.

See Chapter 3 Electrical Installation for electrical installation details.

To complete mechanical installation and setup, you must:

- Review the details of your application's requirements
- Erect mounting structure or other supporting structures
- Determine and mark the Mounting Bracket location(s)
- Mount the bracket to the mounting structure
- Mount the DX8210 to its mounting bracket
- Mount the photoelectric sensor to the mounting structure (optional)
- Mount the tachometer to the mounting structure (optional)
- Mount the CBX connection box to the mounting structure
- Mount the SC5000 to the mounting structure
- Complete electrical installation (*See Chapter 3*)
- Align the DX8210 for proper operation
- Configure the DX8210 (*See Chapter 4*)
- Check DX8210 operations (*See Chapter 5*)

2.4 WHAT YOU NEED TO KNOW ABOUT YOUR APPLICATION

To assure you get optimal performance out of your DX8210, it must be installed to meet the complete needs of your application. Therefore, take the time to learn the details of your application. The better you know your application, the easier it is to apply the DX8210's capabilities to meet your application's requirements.

Below is what you will need to know before you can begin installation:

- Conveyor Specifications
 - Conveyor type: Belt, tilt-tray, cross belt, other?
 - What is the conveyor width?
 - What is the conveyor speed?
 - Does conveyor speed vary or is it constant?
- Product Specifications
 - Are the packages being transported always singulated (not touching) or non-singulated (possibly touching)?
 - How many different product sizes may be involved?
 - Are products justified: toward/away from reader, centered, or variable?
- Application Specifications
 - How will the barcode information be used in your application?
 - What are your communication requirements?

While it is nearly impossible to cover all application configurations, the next several pages provide the basics on determining how to mechanically install your DX8210. If you need additional assistance, contact your sales representative or customer service (www.datalogic.com).

2.5 MECHANICAL INSTALLATION

2.5.1 Dimensions and Clearances

The overall dimensions of the DX8210 are 384 x 128 x 328 mm [15.1 x 5 x 12.9 in].

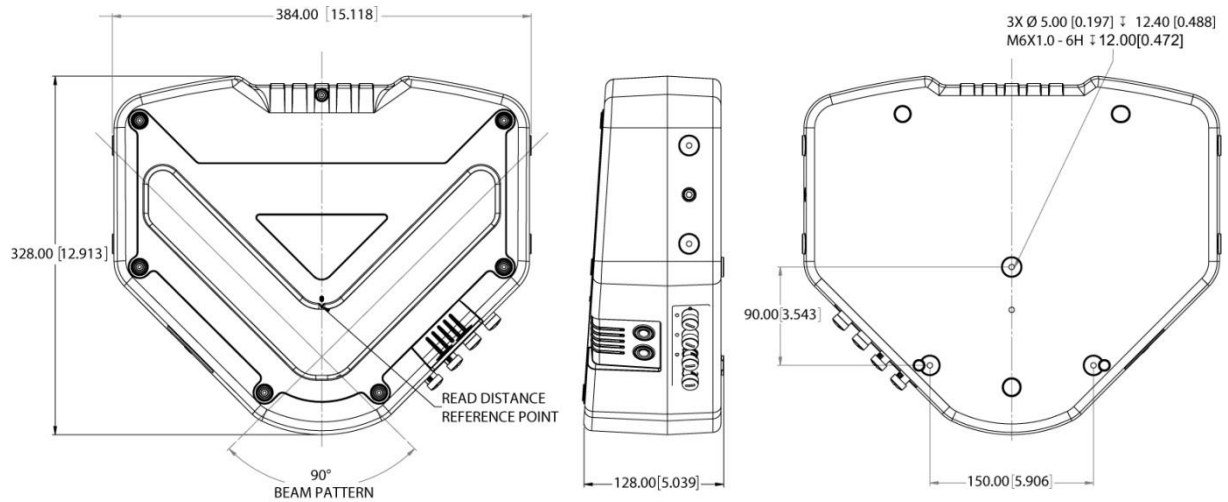

Figure 13: DX8210 Overall Dimensions



IMPORTANT: The DX8210 is a sealed, unventilated unit. Mounting the unit with 300mm [12 inches] of clearance (front, top, and sides) is recommended for cooling and ease of maintenance.

2.5.2 Physical Support Requirements

For details on the weight of the barcode scanners, see *Chapter 8, Technical Features*. Multiple-head systems may include further details on the physical support requirements with any application-specific documentation provided.

2.5.3 Vibration Limitations

See *Chapter 8, Technical Features*.

2.5.4 General Mounting Guidelines

It is important that you follow these general precautions when installing, setting up, operating, maintaining, troubleshooting, or replacing any Datalogic products, parts or related equipment.

As you plan and install your DX8210 barcode scanning system application, be sure to keep the following guidelines in mind:

- All mounting structure assembly and equipment installation can be performed by one installer.
- Determine the proper orientation and position of the barcode scanner.
- Leave adequate clearances (approximately 300 mm [12 inches]) for wiring.
- Route wires carefully to reduce or minimize electrical noise. When power and communication wiring must cross, make their intersection perpendicular.
- Proper grounding limits the effects of noise due to Electromagnetic Interference (EMI).

2.5.5 Mounting Structure Considerations

Your first task is to mount your DX8210 barcode scanner. You can provide your own mounting structure or Datalogic can design one for you. We recommend using a Datalogic mounting structure for standard applications.

Your mounting structure must provide the following capabilities:

- It is adjustable enough for you to move your unit to the optimum position for proper scanning.
- It allows a technician access to the barcode scanner while it is mounted.
- It must be as vibration free as possible so as not to affect the scanning accuracy.
- It is constructed of steel or aluminum.
- It provides approximately 300 mm [12 inches] minimum clearance on all sides. This clearance is necessary to provide proper ventilation, allow access to all panels of the barcode scanner, and allow room for proper servicing.

2.5.6 Mounting the Scanner

The DX8210 can be installed to operate in any position. There are screw holes (M6 X 8) on the sides and back of the scanner for mounting. The diagram below can be used for installation; refer to your application drawing for correct positioning of the scanner with respect to the reading zone and scanner orientation.

There are two bracket options for mounting the DX8210, the large rear-mounted L-Bracket (93ACC0151, included in the box with the reader), and two smaller side-mounted L-Brackets (93ACC0079, optional accessories).

Large Rear-Mounted L-Bracket

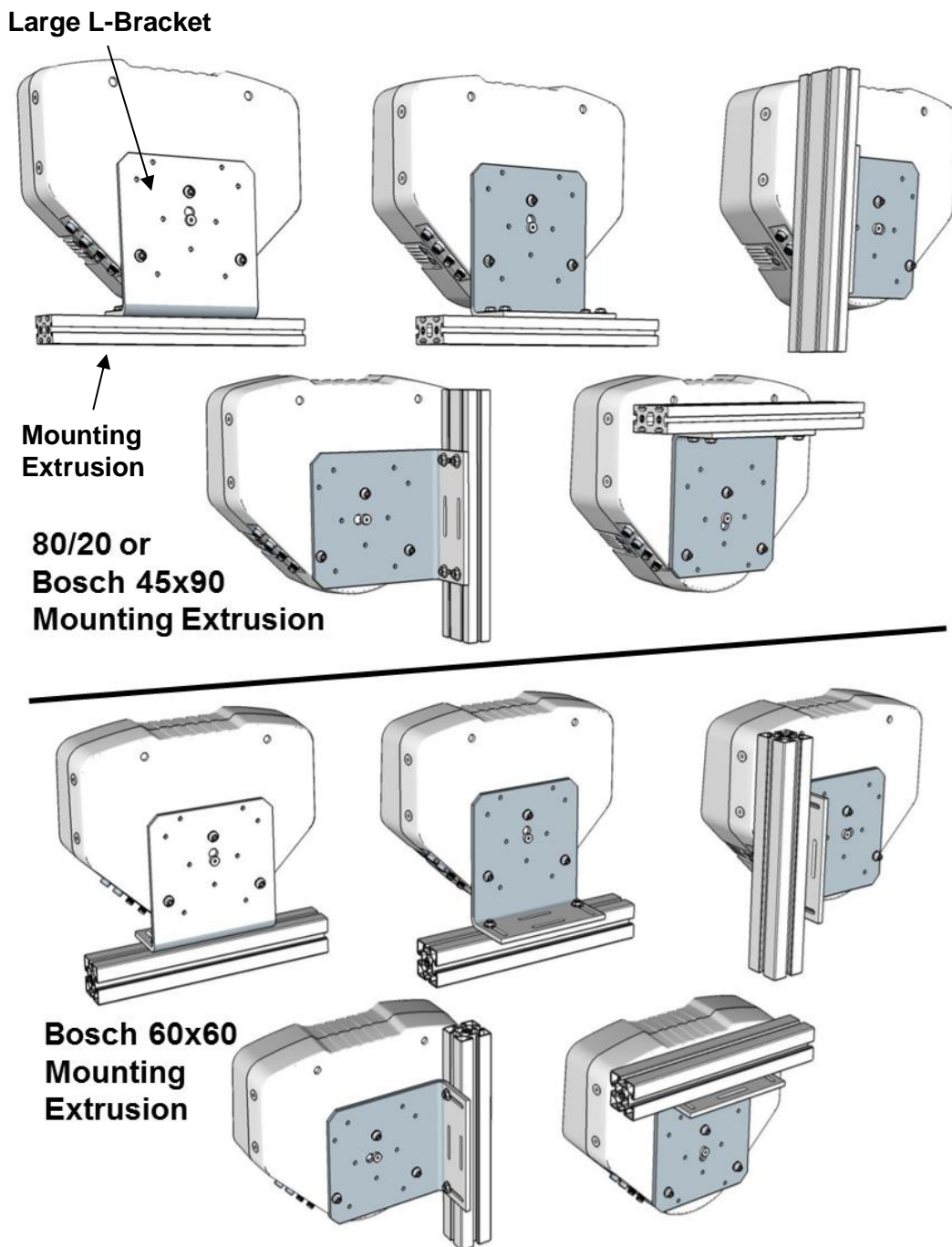

Figure 14: DX8210 Large L-Bracket Mounting Options (93ACC0151, Included with Reader)

To aid in mounting the DX8210 with the large L-Bracket, mount the bracket to the mounting structure as shown. Next, insert the shoulder screw (provided) into the central mounting hole in the back of the unit, and then hang the scanner using the brackets keyhole, as shown in figure 14 below. Finally, secure the scanner to the bracket with mounting screws.

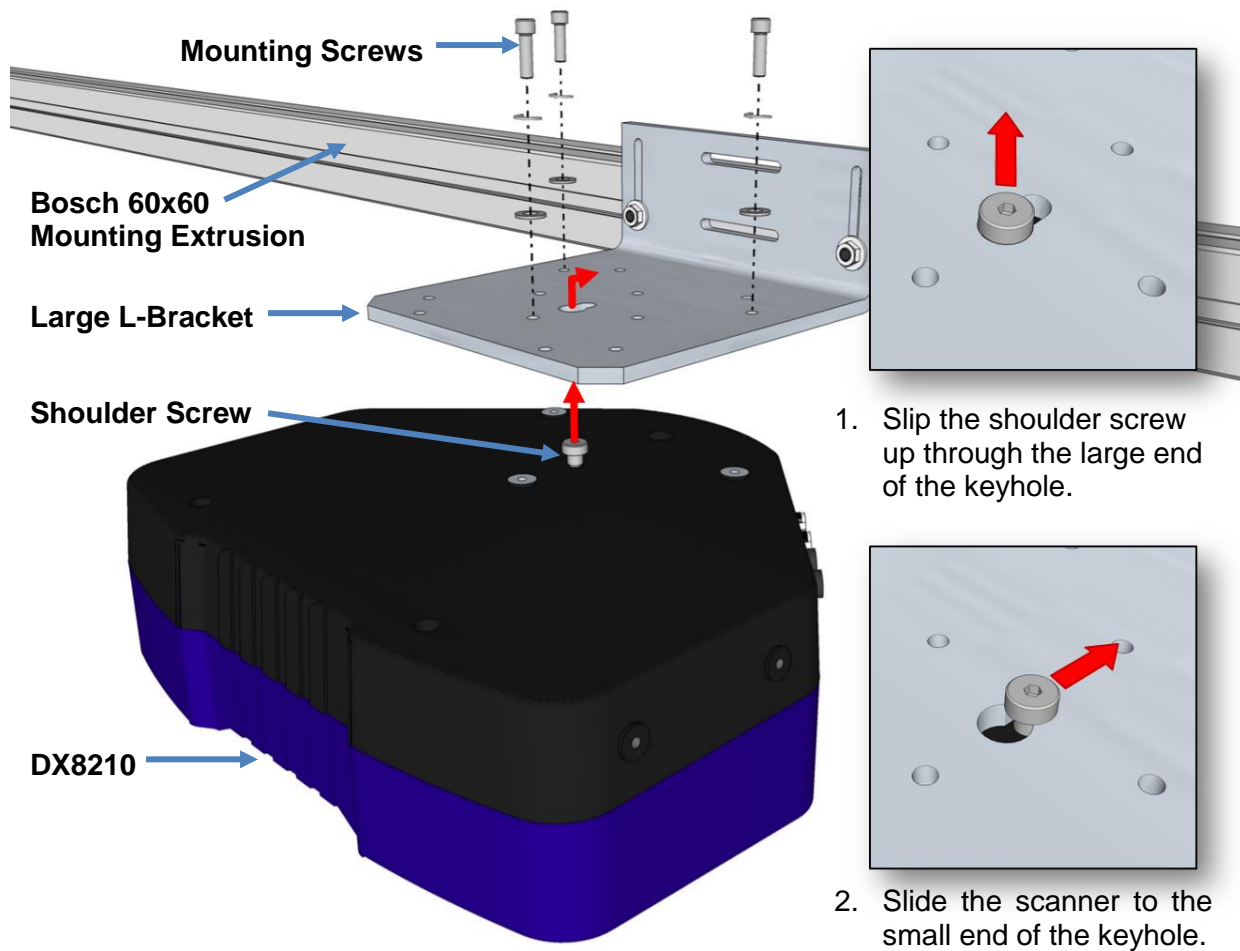

Figure 15: Keyhole mounting with large L-Bracket (Bosch 60x60 Extrusion)

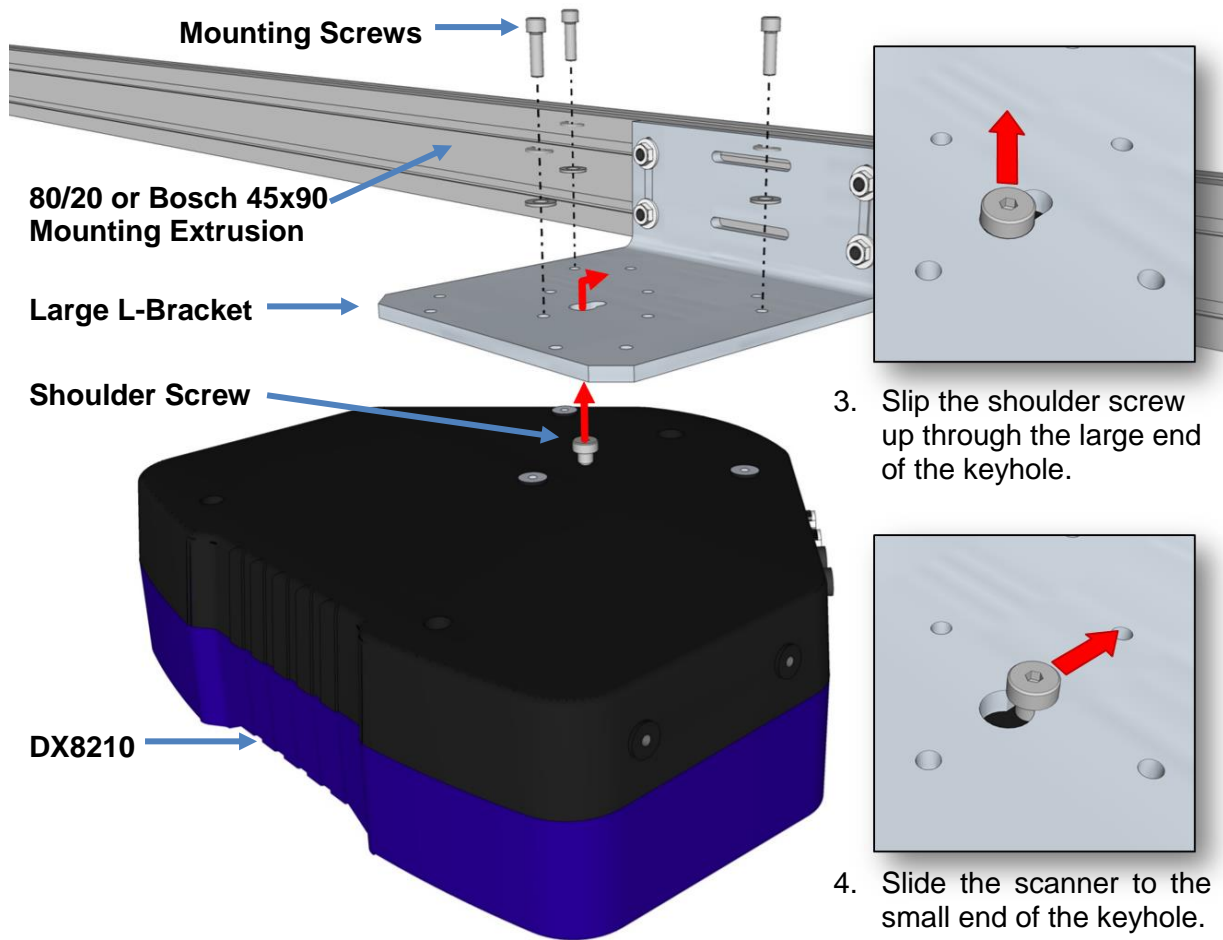

Figure 16: Keyhole mounting with large L-Bracket (80/20 or Bosch 45x90 Mounting Extrusion)

Small Side-Mounted L-Brackets

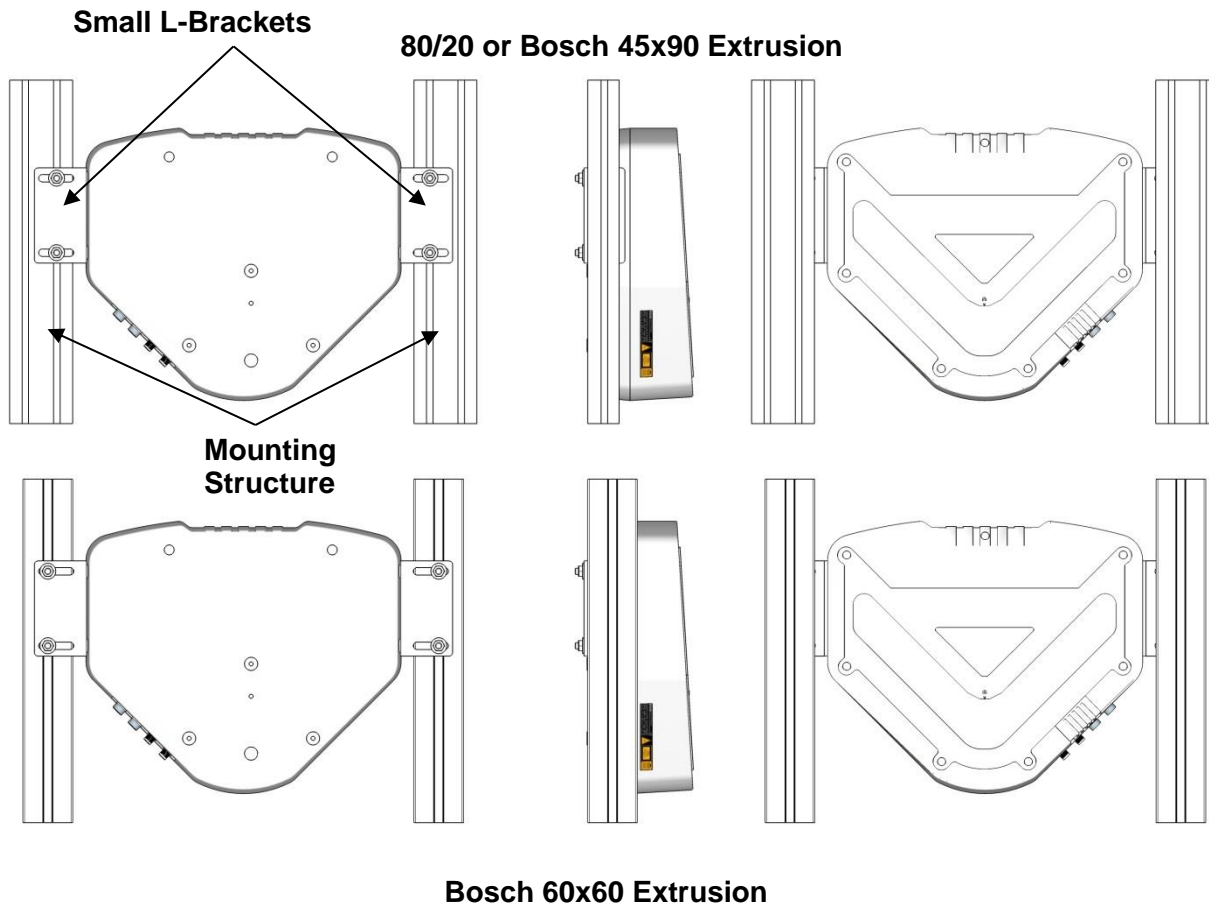

Figure 17: DX8210 Small L-Brackets Mounting Options (93ACC0079)

3 ELECTRICAL INSTALLATION



WARNING: Electrical Installation by Qualified Service Technicians Only! Procedures may involve exposure to high-voltage. A trained and authorized technician must perform these procedures. Do not attempt to perform any electrical installation procedures unless you are a trained technician.



IMPORTANT: The DX8210 barcode scanners contain electronics that may be affected by electrostatic discharge (ESD). To prevent personal injury or damage to the unit, please follow the safety precautions and warnings found in the References section at the beginning of this manual. Failure to follow these precautions may void your warranty.

3.1 PREPARING FOR ELECTRICAL INSTALLATION

Before mounting any components, please do the following:

- Read all instructions before beginning your installation.
- Observe all electrical safety requirements discussed in the Introduction to this manual.
- Define and confirm the accuracy of your application's requirements.
- Review all installation-specific drawings.
- Review and plan the power requirements for your application.
- Review and plan the communications requirements for your application.



IMPORTANT: The content of this manual may be superseded by any customer-specific documentation provided by Datalogic. Before proceeding with any installation procedures, be sure to review ALL documentation, especially content that contains details specific to your installation.



NOTE: Everything should be **MECHANICALLY INSTALLED** before performing any **ELECTRICAL INSTALLATION**. See Chapter 2 for mechanical installation details.

Most DX8210 applications are shipped with the CBX connection box and all the necessary cabling required to electrically install the system. If your system requires custom-length cables or other special wiring, documentation specific to these requirements has been provided in your shipment. This special documentation supersedes any contradictory content in this manual.



NOTE: To reduce the possibility of damage to the unit, check all cabling between the scanner and other devices for accuracy.

3.2 CONNECTING A DX8210 SCANNER

To install a DX8210 barcode scanner, follow this sequence:

- Complete mechanical installation (*See Chapter 2.*)
- Complete electrical installation (*See wiring illustrations provided in this chapter.*)
- Observe all electrical safety requirements outlined in this chapter.
- Ground the mounting structure to protective earth (PE) ground.
- If used, wire the photoelectric sensor (or other trigger) to the CBX connection box/SC5000.
- Wire the tachometer to the CBX connection box/SC5000 (if used).
- Wire serial ports to the CBX connection box/SC5000 if needed.
- Connect the M12 end of the Ethernet cable to the scanner's HOST port and network switch as required by your application.
- Connect the scanner to its power supply.
- Connect the power supply to the power source.
- Setup / check scanner operations (*See Chapter 5.*)

3.3 TYPICAL CONNECTION BLOCK DIAGRAMS

3.3.1 Single DX8210 Barcode Scanner to CBX

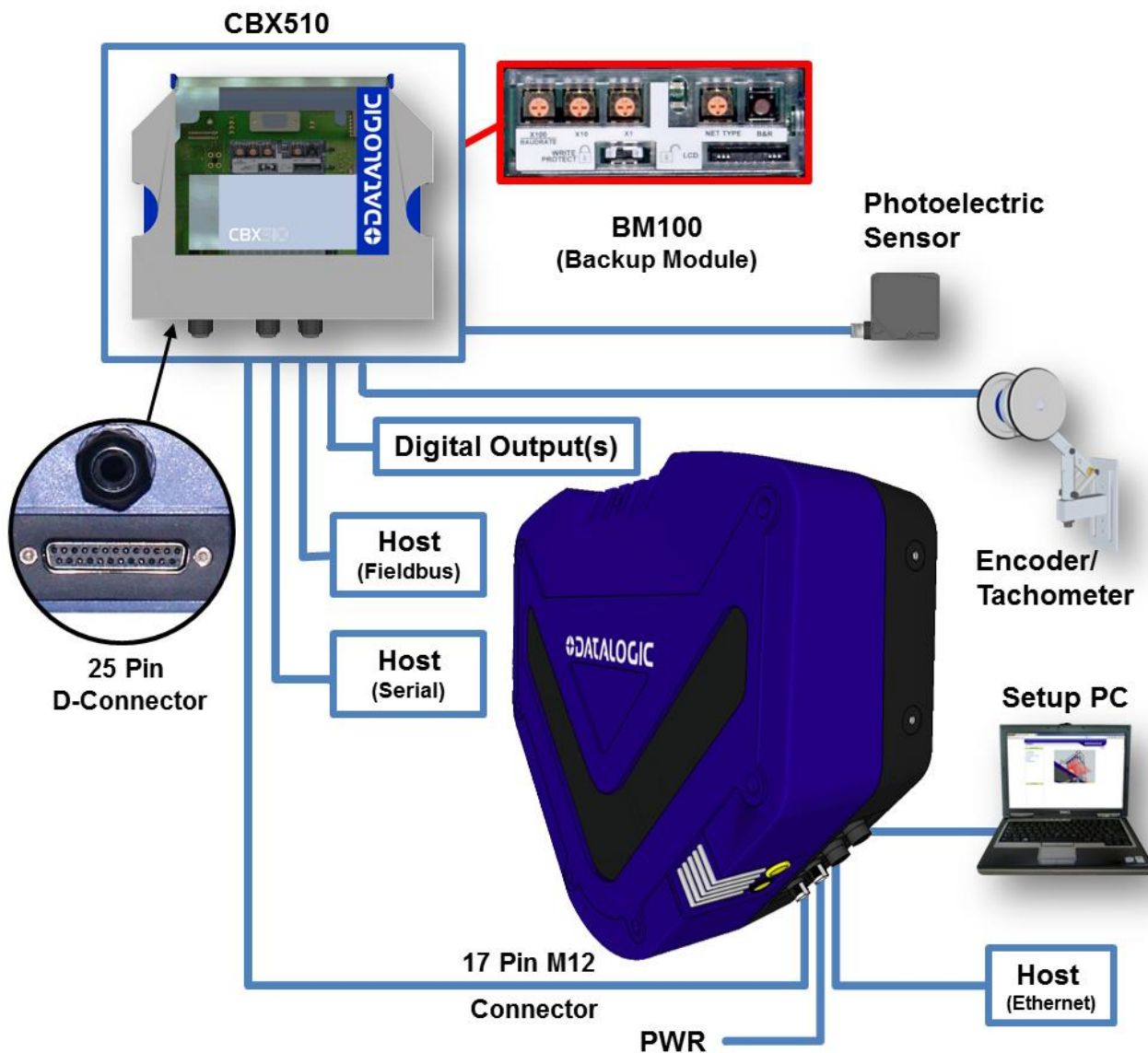

Figure 18: Single DX8210 to CBX510



NOTE: The BM100 switches indicated below must be set to 0 (zero), and the connector indicated is not supported.

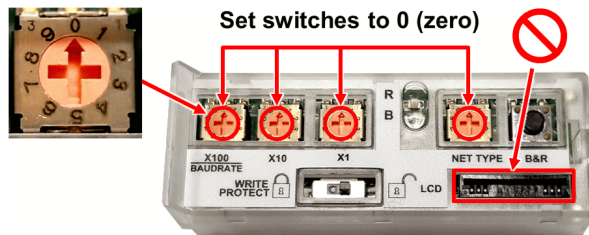

Figure 19: BM100 Backup Module in CBX510

3.3.2 Master/Slave Array with CBX510

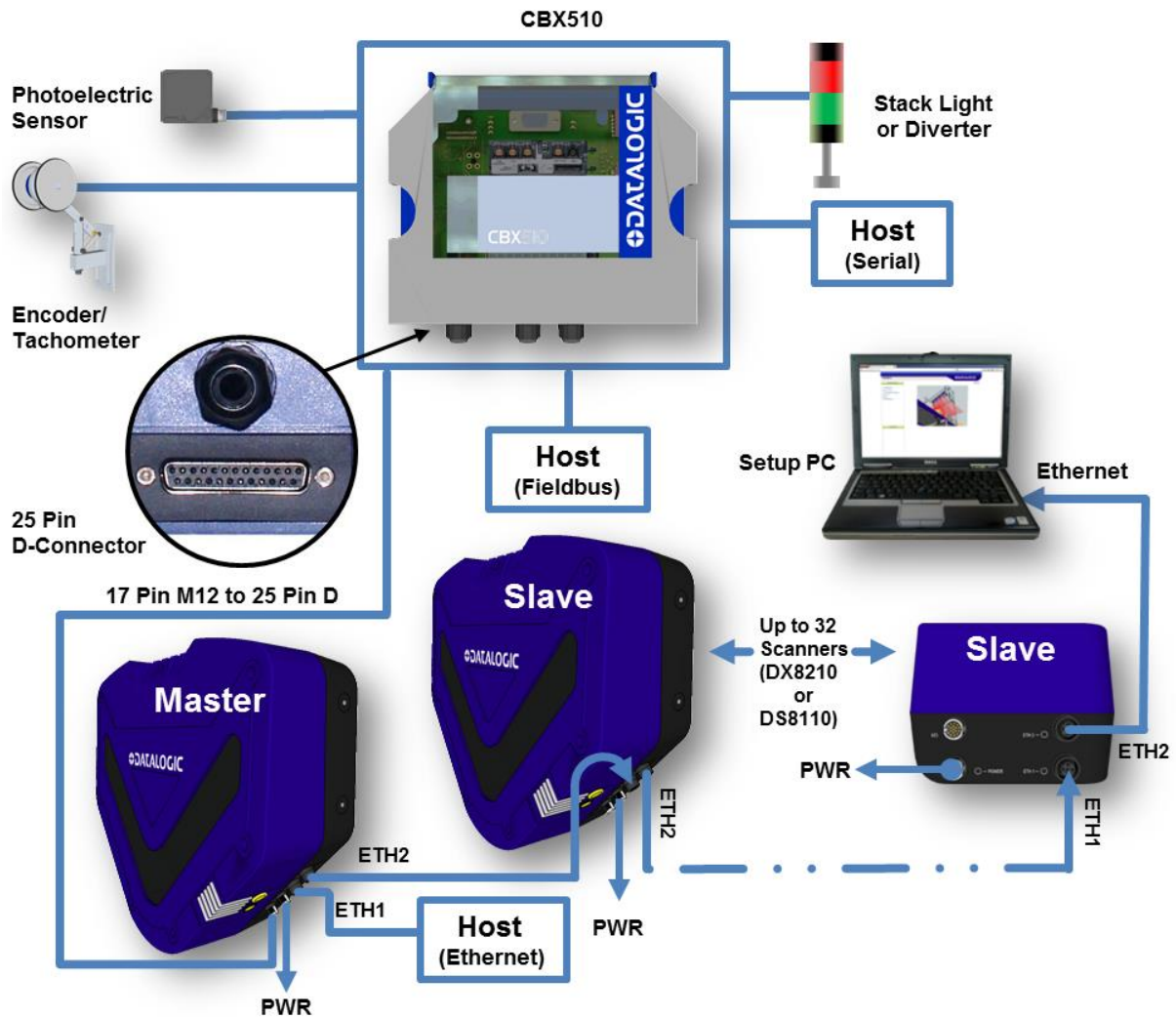

Figure 20: DX8210 Array (Tunnel) to CBX510



NOTE: The BM100 switches indicated below must be set to 0 (zero), and the connector indicated is not supported.

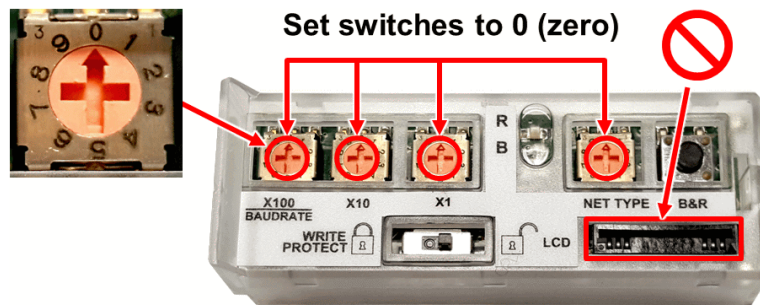

Figure 21: BM100 Backup Module in CBX510

3.3.3 DX8210 Barcode Scanners in an Array with SC5000 Master

In an array (tunnel) using the SC5000 Controller, the chain of scanners completes a circle from and to the SC5000 Controller via ETH1 and ETH2. In this scenario, if one scanner fails, communication from the other scanners to the SC5000 Controller is not interrupted.

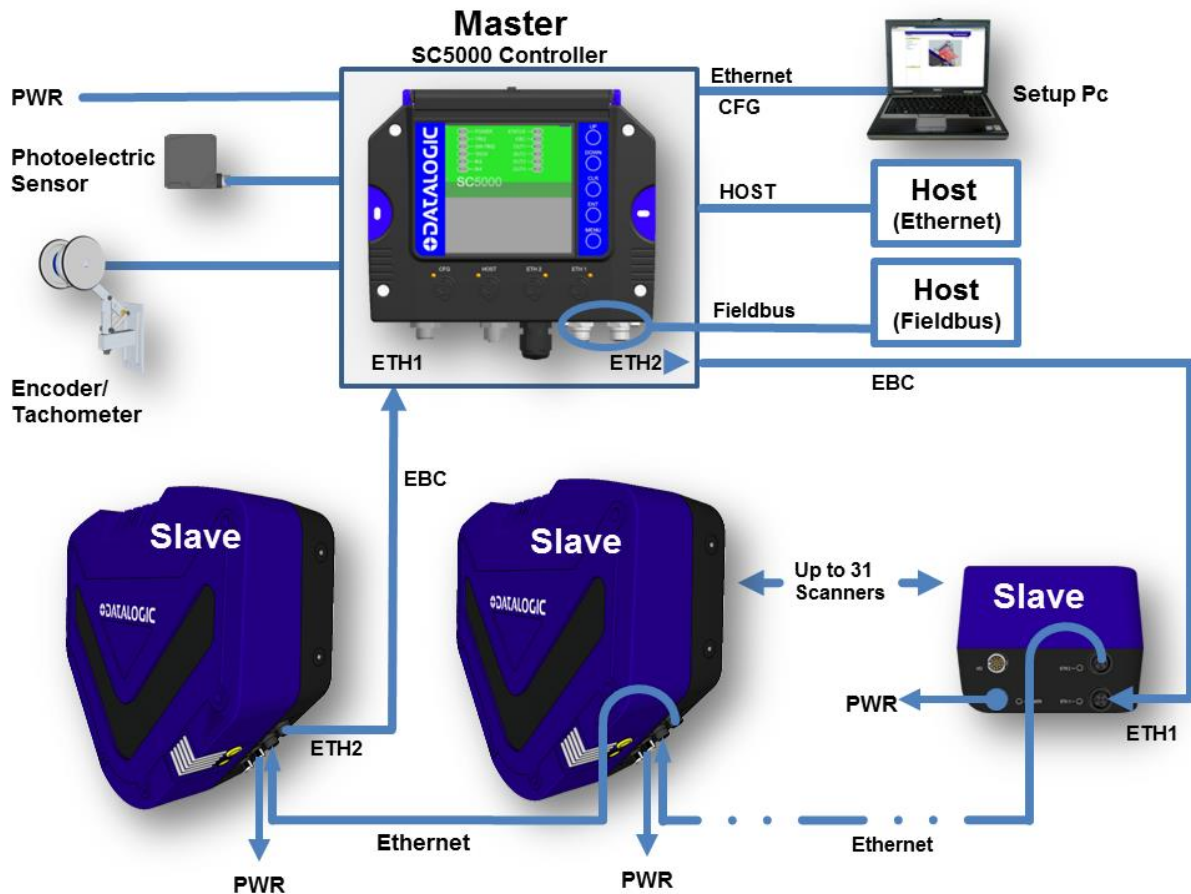

Figure 22: DX8210 Array (Tunnel) with SC5000



NOTE: When using the SC5000, a **Fieldbus Host** only connects to the SC5000 Fieldbus model (Profinet or Profibus) at the connectors shown. It cannot connect to the CBX.

An **Ethernet Host** connects to the **HOST** connector on the SC5000 top cover. A **Serial Host** must connect through the CBX (see Figure 23).

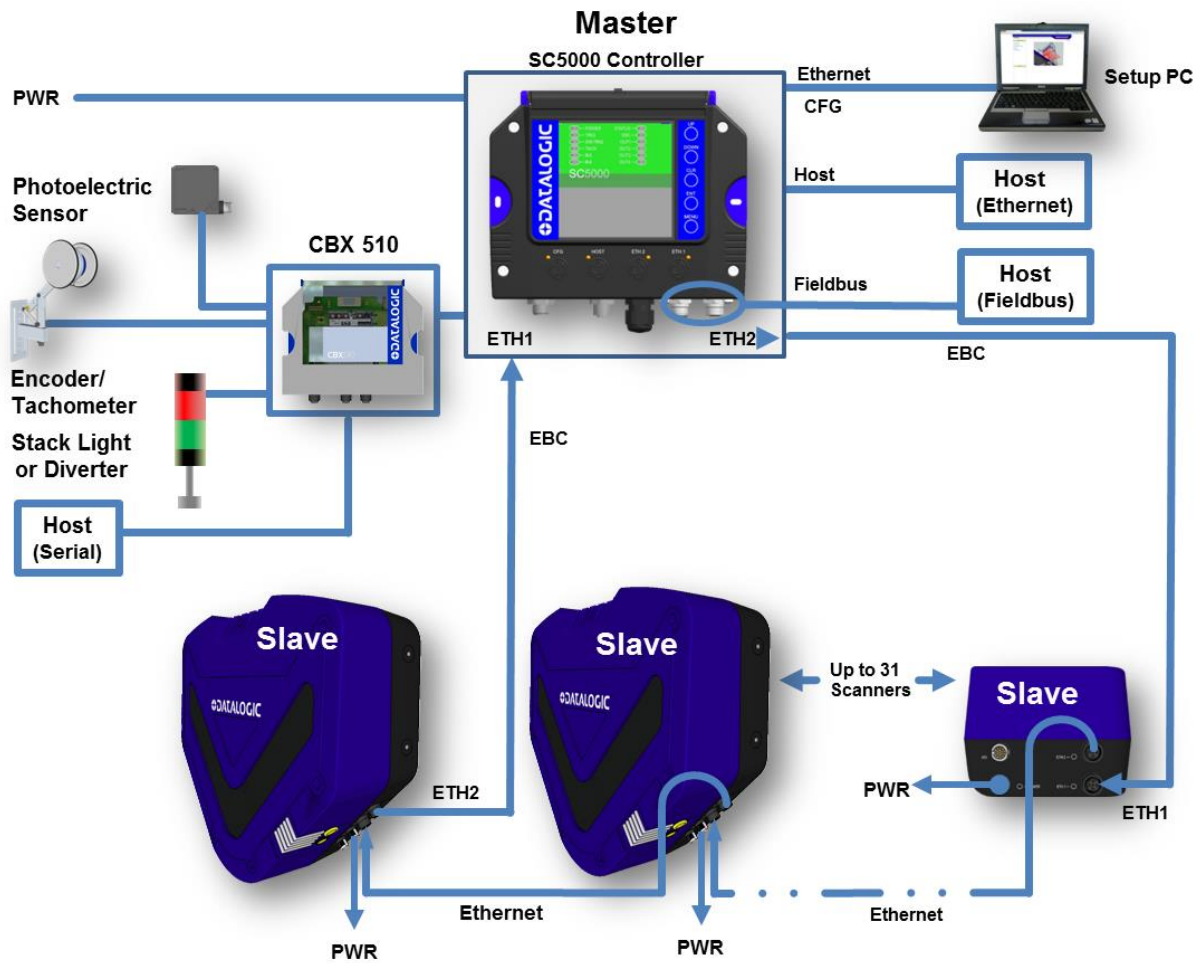

Figure 23: DX8210 Array (Tunnel) to SC5000 (alternate with CBX)

3.4 GENERAL ELECTRICAL INSTALLATION GUIDELINES AND PRECAUTIONS

It is important that you follow these general precautions when installing, setting up, operating, maintaining, troubleshooting or replacing any Datalogic products, parts or related equipment. As you plan and install your scanner(s), be sure to keep the following guidelines in mind:

- Determine the scanner is in the proper location as outlined in Chapter 2.
- Leave adequate clearances (approximately 300mm [12 inches]) for wiring.
- Route wires carefully to reduce or minimize electrical noise.
- When extraneous power and communication wiring must cross, make their intersection perpendicular. Avoid running power and data wiring parallel to each other. If possible, maintain one of the following separations between the power and data wiring:
 - 300 mm [12 inch] gap
 - use steel conduit and 25 mm [1 inch] gap
 - 6.5 mm [0.25 inch] of aluminum.



IMPORTANT: When planning your installation wiring, remember all power connections must be quick-disconnect. For PERMANENTLY CONNECTED EQUIPMENT a readily accessible disconnect device must be incorporated in the building installation wiring. For PLUGGABLE EQUIPMENT the socket-outlet must be installed near the equipment and must be easily accessible



WARNING: To assure no ESD damage will occur, be sure to observe the precautions outlined in the Introduction to this manual.



IMPORTANT: Ground the mounting structure to safety ground (protective earth ground (PE)). See wiring recommendations for safety ground.

3.5 DX8210 CONNECTOR PANEL

After completing mechanical installation, use this section to properly wire your scanners for optimal performance in your application. DX8210 wiring connections are made to the connector panel and through the CBX connection box (connected to the I/O port of the scanner). In most applications, the cable connections to the scanner will include:

1. ETH 2 (Setup or EBC scanner network, default IP Address: 192.168.3.100)
2. ETH 1 (Host or EBC scanner network, default IP Address: 172.27.101.220)
3. POWER
4. I/O (Connects directly to the 25-pin D type connector on the CBX connection box)



NOTE: The M12 I/O connector Vcc pin is allowed a max sink current of 0.6A.

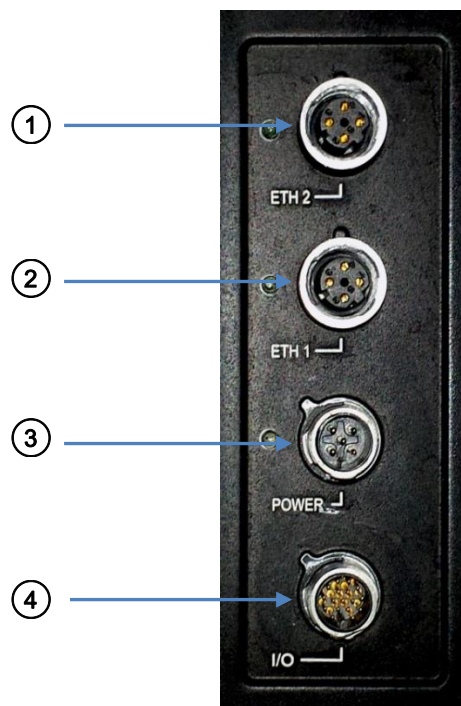

Figure 24: DX8210 Connector Panel

Route wiring to the scanner's connector panel through the wiring channels (if available) on the Datalogic mounting structure when running interconnecting cables between other devices and the scanner.



Figure 25: Wiring Channels

3.6 CONNECTING A PC TO THE DX8210

During initial setup, a PC (laptop) may be connected to the DX8210 with a M12 to RJ45 cable. Screw the M12 connector to the ETH 2 port of the scanner and plug the RJ45 into the Ethernet port of your PC. If the ETH 2 port is in use, ETH 1 port can be used. For information on connect to **e-Genius**, see *Chapter 4*.



NOTE: ETH2 is typically the **Setup** port, ETH1 is the **HOST** port.



NOTE: A laptop can only communicate to a scanner that is connected to a CBX Connection Box or SC5000 Controller.



NOTE: Parameters for tunnel are set up in MASTER scanner (or SC5000 Controller only.)

3.7 POWER CONNECTOR PIN-OUT TABLE

A recommended power supply and cabling is available with the DS8110 and DX8210 (and SC5000 Controller). However, if your installation requires custom power supply wiring, the pin-outs of the unit power connector are provided below for your convenience.

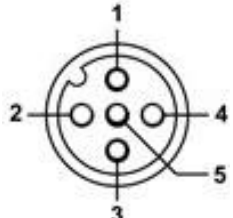
| 24V - - - 4A MAX | | POWER Input | |
|---|-----|----------------------------|------------------------|
| | | Unit Connector (shown) | Mating cable connector |
| | | 5-PIN M12-TYPE MALE | 5-PIN M12-TYPE FEMALE |
| MALE 5-PIN M12-TYPE  | Pin | Function | |
| | 1 | +24 VDC | |
| | 2 | n/c | |
| | 3 | dc return | |
| | 4 | n/c | |
| | 5 | protective earth (chassis) | |



NOTE: When using a DX8210 barcode scanner, no power supply is required for the CBX510 connection box. All power and some communication options are fed to the CBX510 through the scanner's 17-pin I/O connector to the CBX510 25-pin connector using the cable provided.



NOTE: In cases where the AS-I cabling is not used, the alternative CAB-LP-05 cable can be used to connect the power supply to the scanner. Connect the Brown/White pair to +24 Vdc and the Blue/Black pair to 0 V-(GND).

3.8 POWER CONNECTIONS



IMPORTANT: When planning your installation wiring, remember all power connections must be quick-disconnect.



CAUTION: While performing the following wiring connection procedures, be sure to follow all safety procedures regarding high-voltage as outlined in the Introduction to this manual. No power should be applied to any device until all wiring is completed and checked for accuracy.



IMPORTANT: The socket-outlet must be installed near the scanner. The outlet must be a readily accessible disconnect device.



GROUND: Ground the scanner to safety ground (protective earth ground (PE)). See wiring recommendations for safety ground.

The CBX connection boxes provide flexible connectivity to a range of I/O devices as well as serial hosting. The DX8210 connects to the CBX via its I/O port using a single 17-pin M12 to 25-pin D cable. The CBX connection box also provides space for an optional BM100 backup module (recommended) for parameter storage, allowing quick replacement and configuration of the scanners.

In a system with multiple scanners and other devices required in a scanning array (tunnel), an SC5000 Controller serves as the system Master and provides communications between devices and to the Host. Complete installation information for the SC5000 Controller is available in the **SC5000 System Controller Reference Manual** available at www.datalogic.com.

3.9 CBX510 CONNECTION BOX

Complete installation information for the connection box is available in the **CBX510 Installation Manual** available at www.datalogic.com. A simple drawing of the interior of the box is shown below.

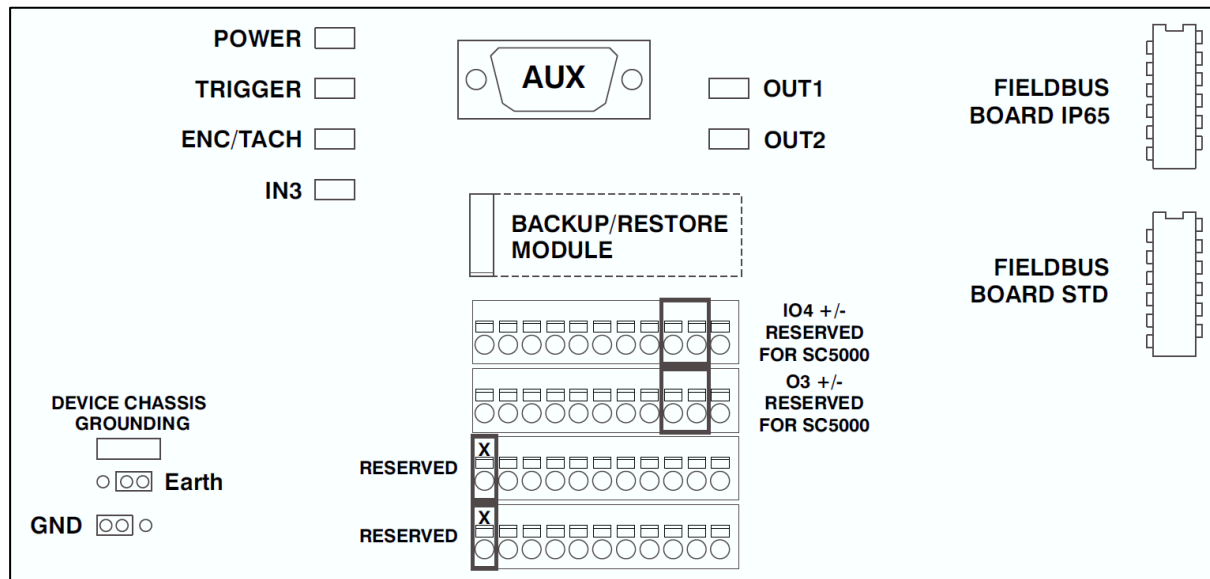

Figure 26: CBX510 Interior

3.9.1 Wiring Into the CBX510 Connection Box



WARNING: DO NOT connect a separate power source to the CBX510 connection box. The CBX510 receives its power through its connection to the DS8110/DX8210 Barcode Scanner. Connecting a separate power source will be detrimental to the system operation.



IMPORTANT: DISCONNECT POWER from the scanning system and CBX510 before wiring any components.

Loose-lead cables must pass through the water-tight seals in the base of the CBX510 connection box. Insert the cables allowing enough slack for the individual wires to reach the appropriate pin block connectors. Securely tighten the water-tight seals after the cables have been inserted.

Insulation on individual wires should be removed to expose 13 mm [0.5 inch] of bare metal before inserting into the pin block.

3.10 MAIN SERIAL INTERFACE

The optocoupled main serial interface is compatible with the following electrical standards:

- RS232
- RS422 full-duplex

3.10.1 RS232 Interface

The main serial interface is used for communication with the Host computer and allows transmission of code data.

It is always advisable to use shielded cables. The overall maximum cable length must be less than 15 m (49.2 ft.).

The following positions of the CBX510 spring clamp connector (row 4) are used for RS232 interface connection:

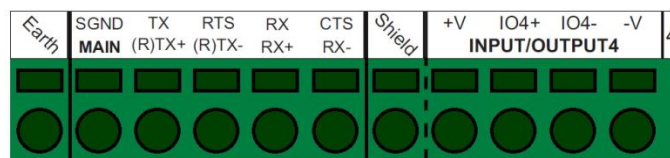

| Name | Function |
|------|--------------------------|
| SGND | Signal ground (isolated) |
| TX | Transmit |
| RTS | Request to send |
| RX | Receive |
| CTS | Clear to send |

As suggested above, the cable shield should be connected in the 'Shield' position.

The RTS and CTS signals control data transmission and synchronize the connected devices. If the RTS/CTS hardware protocol is enabled, the scanner activates the RTS output to indicate a message can be transmitted. The Host must activate the CTS input to enable the transmission.



IMPORTANT: RTS/CTS lines should only be connected if the Main serial port handshaking is configured for **Hardware (RTS/CTS)** (see section 4.5.4).

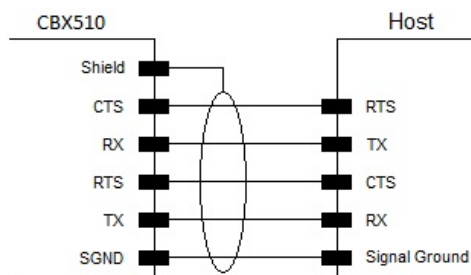
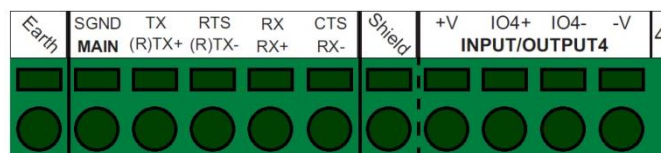

Figure 27 - RS232 Connections: Host – CBX510

3.10.2 RS422 Full-Duplex Interface

The RS422 full-duplex interface is used for non-pollled communication protocols in point-to-point connections over longer distances (max 1200 m / 3940 ft.) than those acceptable for RS232 communications or in electrically noisy environments.

The following positions of the CBX510 spring clamp connector (row 4) are used for RS422 full-duplex interface connection:



| Name | Function |
|------|--------------------------|
| SGND | Signal ground (isolated) |
| TX+ | RS422 output (+) |
| TX- | RS422 output (-) |
| RX+ | RS422 input (+) |
| RX- | RS422 input (-) |

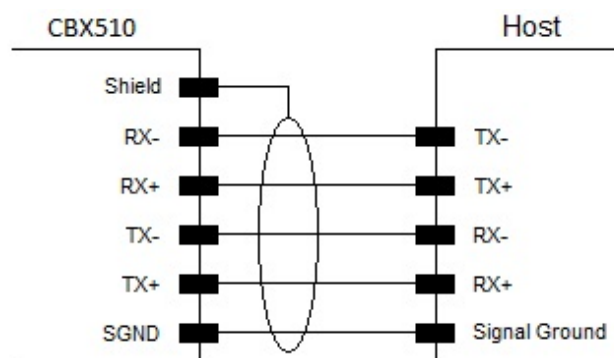

Figure 28 - RS422 Full-Duplex Interface Connections: Host – CBX510



IMPORTANT: For applications that do not use RS422 RX signals, do not leave these lines floating but connect them to SGND as shown below.

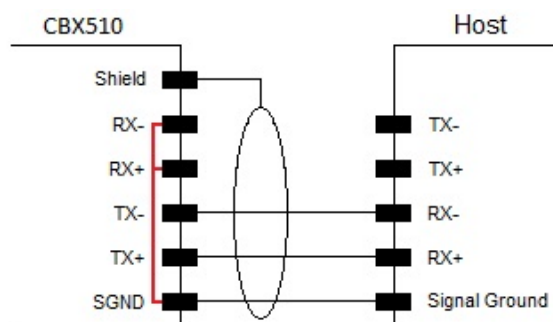

Figure 29 - RS422 Full-Duplex Interface Connections Using Only TX Signals: Host - CBX510

3.11 PHOTOELECTRIC SENSOR CONNECTIONS TO CBX510

Barcode scanning applications may use a Datalogic photoelectric sensor as a trigger device. The photoelectric sensor is wired directly into the CBX510 terminal block.

If your application uses a trigger other than the one specified by Datalogic, follow the appropriate wiring diagram to assure proper wiring.



NOTE: To confirm the photoelectric sensor is functioning properly, watch the TRIG LED while the photoelectric sensor's beam is blocked. The Datalogic photoelectric sensor also includes a status LED.

The following diagrams illustrate standard recommended wiring of the Photoelectric Sensor to the CBX510 terminal block.

3.11.1 Photoelectric Sensor (NPN)

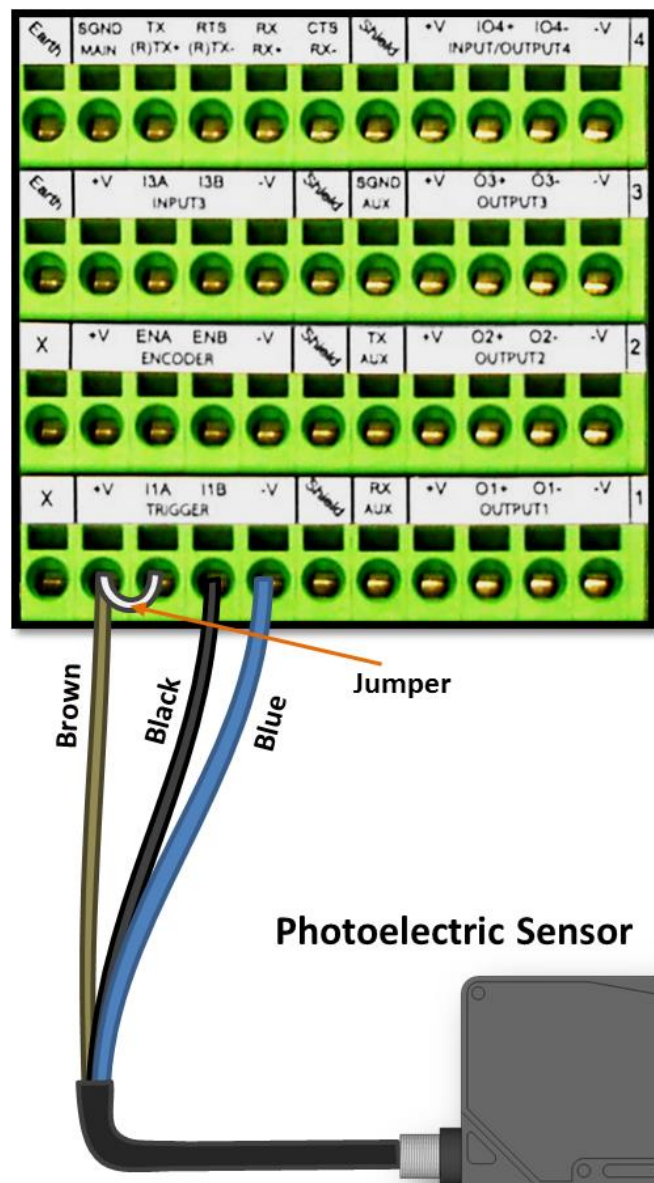

Figure 30: Photoelectric Sensor Wiring (NPN Output)

3.11.2 Photoelectric Sensor (PNP)

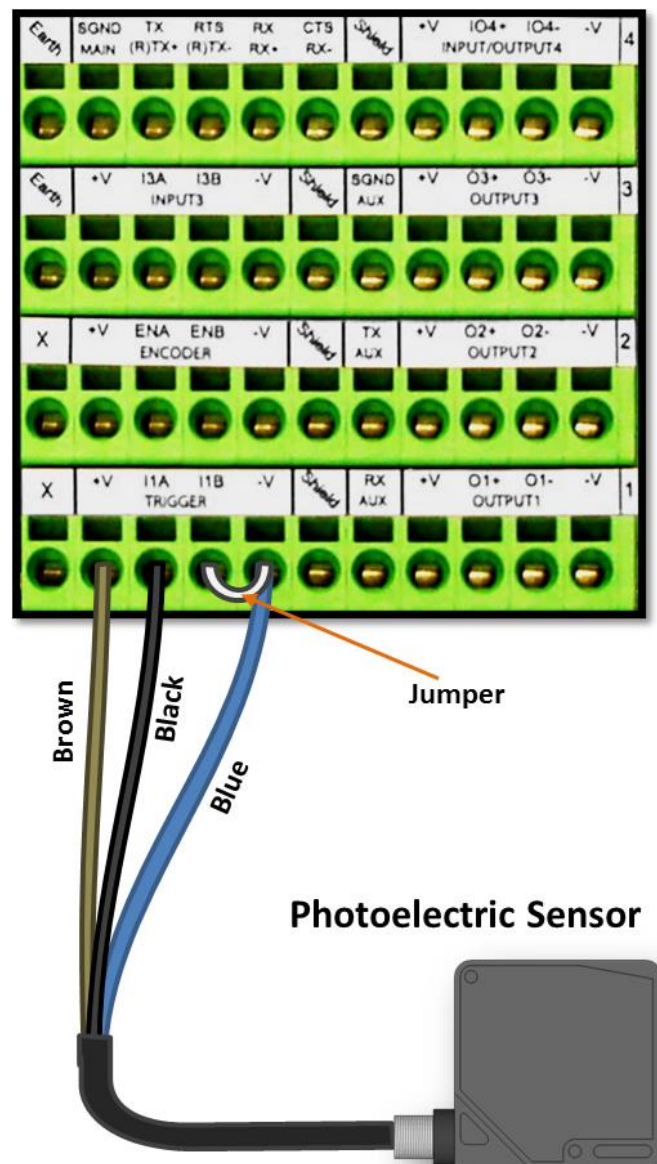

Figure 31: Photoelectric Sensor Wiring (PNP Output)

3.12 TACHOMETER WIRING TO CBX510 OR SC5000 CONTROLLER

DX8210 applications over a conveyor belt use an encoder (tachometer) and mounting kit. The following diagrams illustrate standard recommended wiring of an encoder to the CBX510 terminal block.

3.12.1 Encoder/Tachometer Wiring for NPN Output (two models)

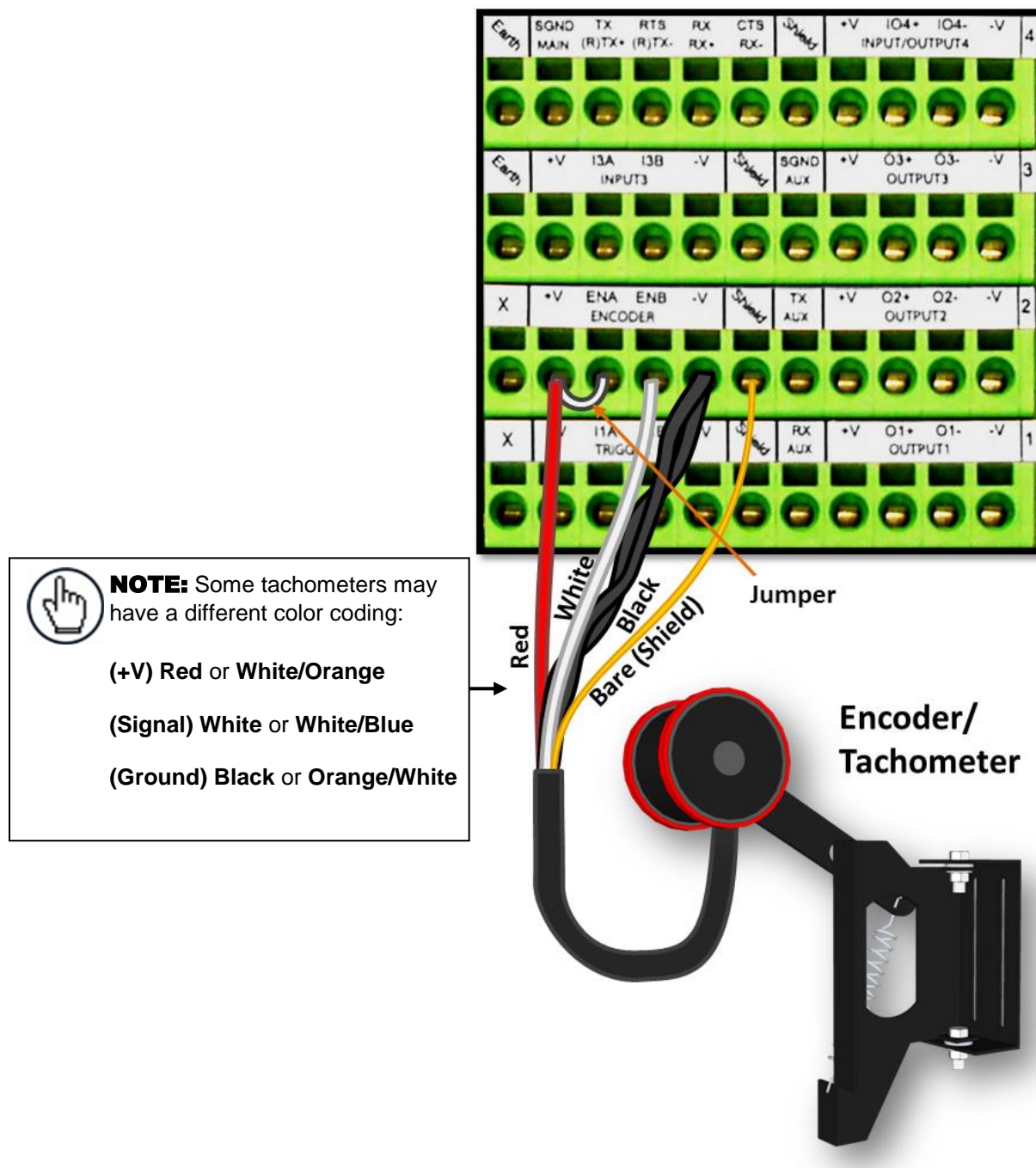

Figure 32: OEK-2 Encoder/Tachometer Wiring (NPN Output)

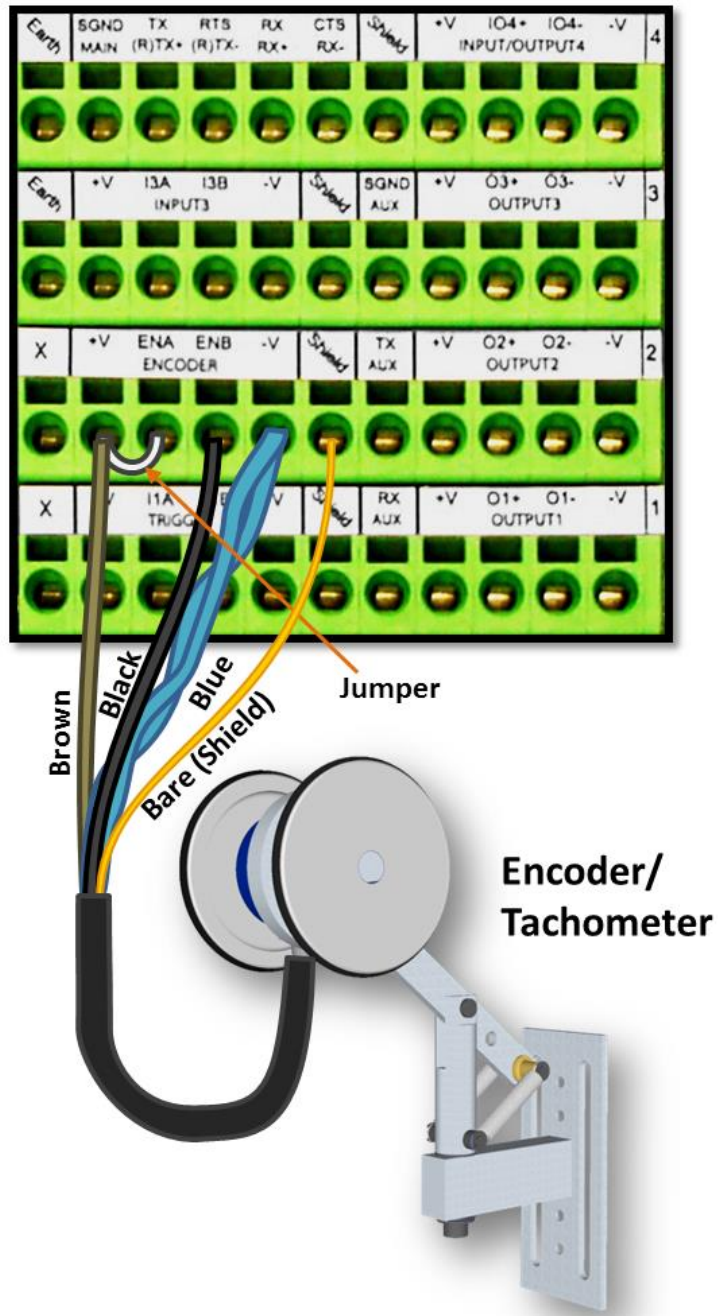

Figure 33: OEK-4 (95B082050) Encoder/Tachometer Wiring (NPN Output)

3.12.2 Encoder/Tachometer Wiring for PNP Output (two models)

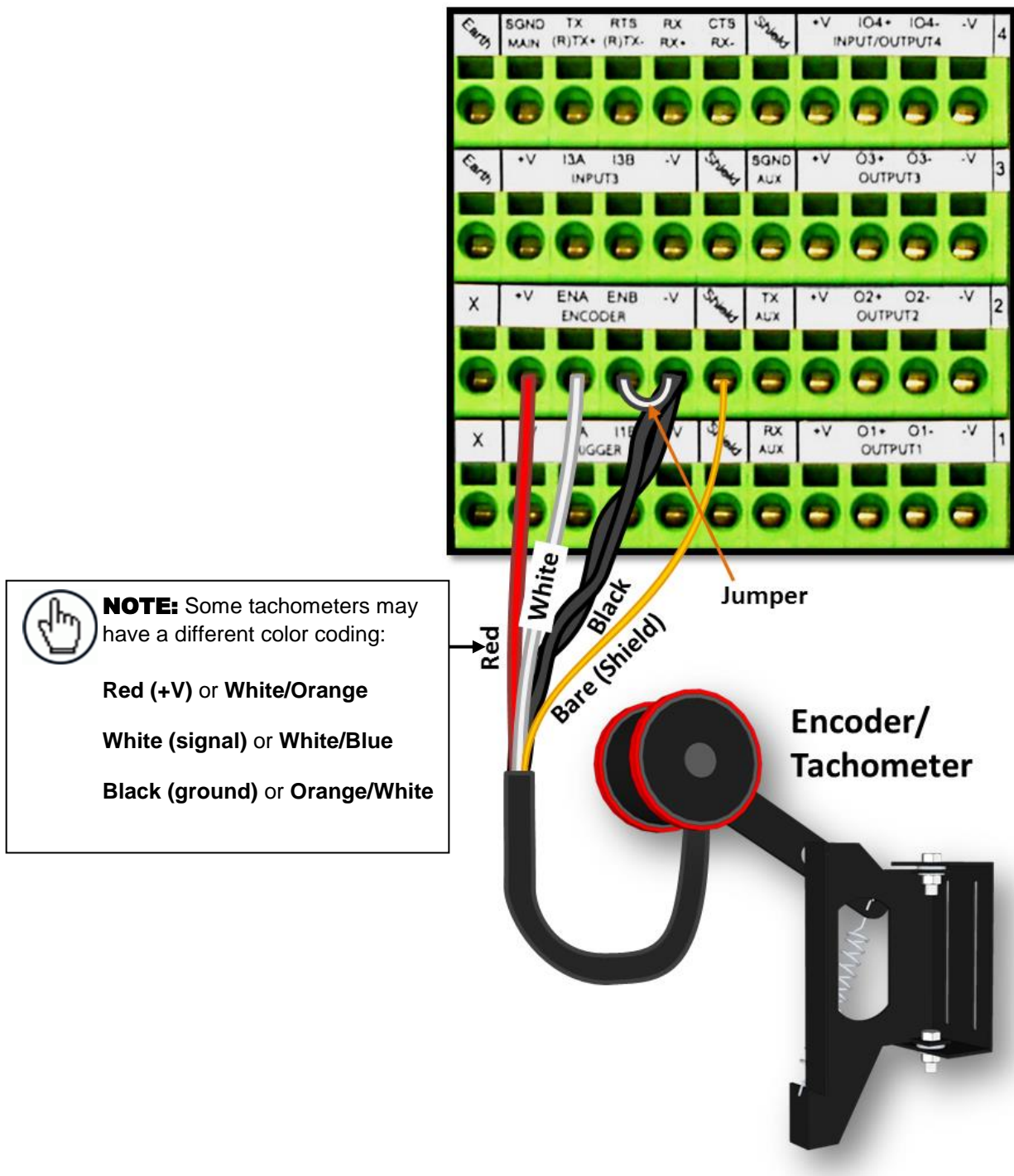

Figure 34: OEK-2 (93ACC1770) Encoder/Tachometer Wiring (PNP Output)

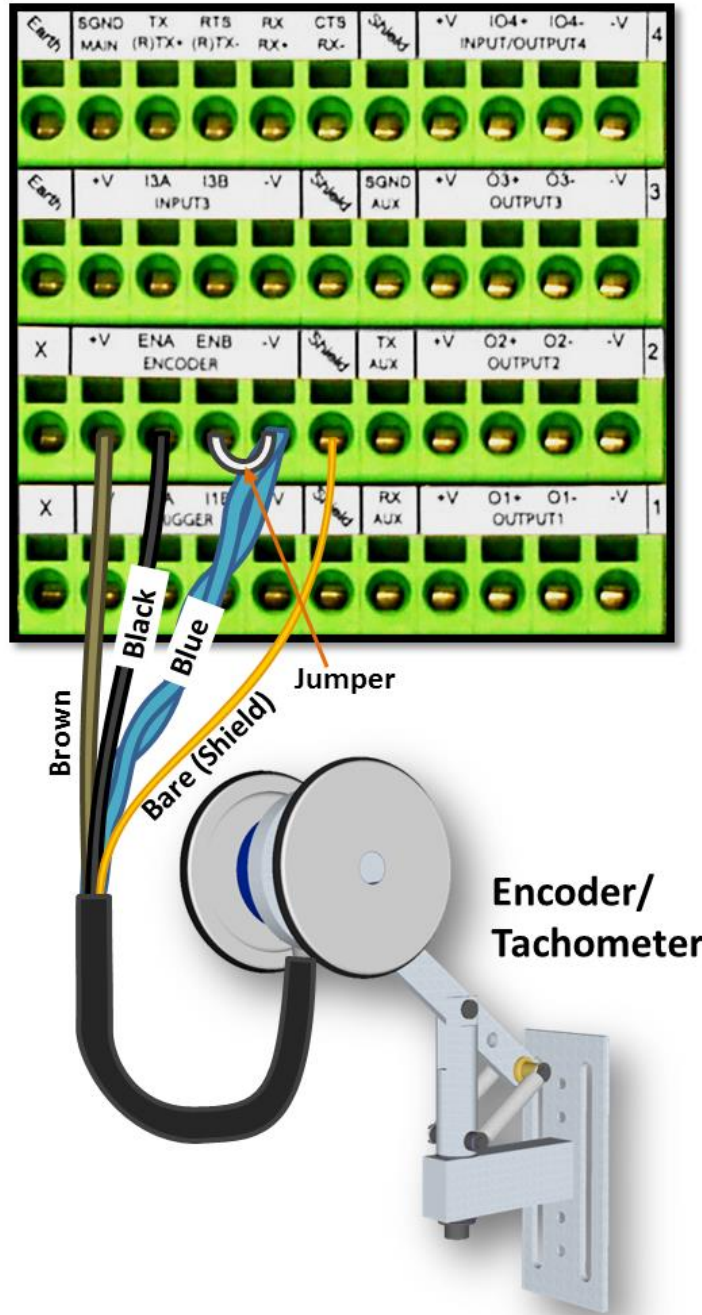

Figure 35: OEK-4 (95B082050) Encoder/Tachometer Wiring (PNP Output)

3.14 DIGITAL OUTPUT CONFIGURATION TO CBX510

The CBX510 includes an OUTPUTS block for wiring relays as needed for external accessories. The **e-Genius Modify Settings | Digital I/O** window includes options for outputs 1 and 2 with **Primary** and **Secondary Activation Event** options including **Complete Read, Partial Read, No Read, Trigger On, Trigger Off, Multiple Read, Right/Match, and Wrong/No Match**.

Schematics for Isolated and Non-Isolated digital outputs are provided below.

| | |
|---|--|
| Outputs 1 - 3 |  |
| Maximum Voltage 30 V | |
| Collector Current (pulse) 130 mA Max. | |
| Collector Current (continuous) 40 mA Max. | |
| Saturation Voltage (VCE) 1 V at 10 mA Max. | |
| Maximum Power Dissipation 90 mW at 50°C (Ambient temperature) | |

Figure 36: OUTPUTS Block

3.14.1 Unpowered Outputs

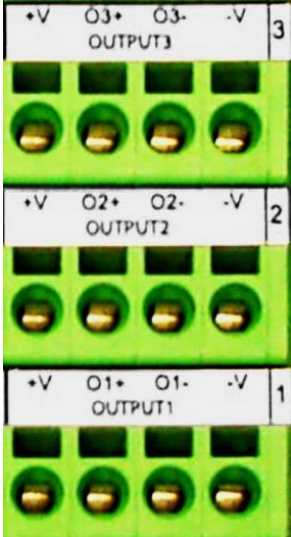
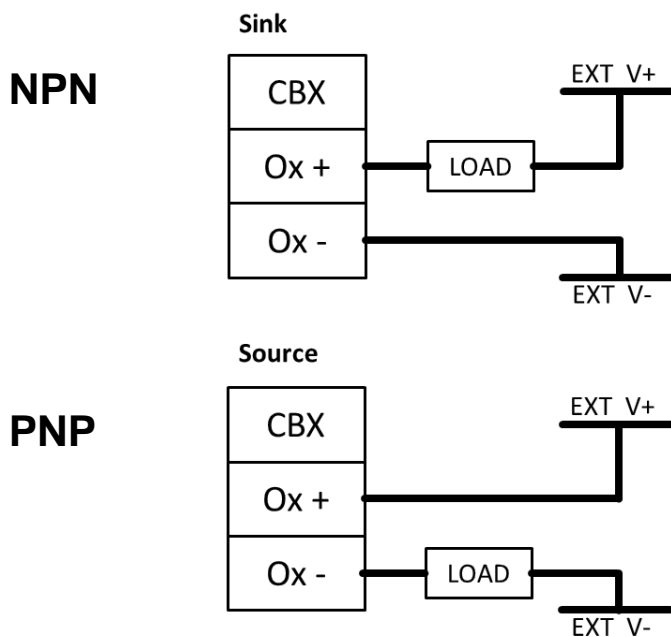

Figure 37: Unpowered Outputs

3.14.2 Powered Outputs

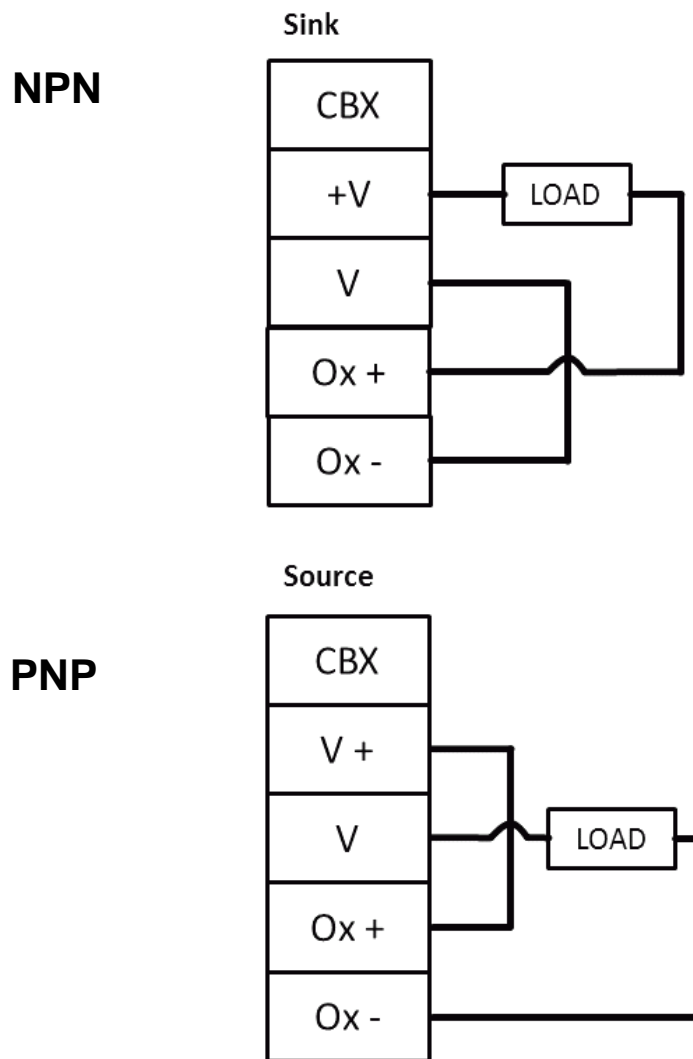

Figure 38: Powered Outputs

3.15 CONNECTING TO THE SC5000 SYSTEM CONTROLLER (OPTIONAL)

In larger scanning arrays (scanning tunnels), an SC5000 controller can act as the system master and support up to 31 slave DS8110/DX82110 barcode scanners in an Ethernet-based connection loop (EBC). SC5000 wiring connections are made to the front and bottom connector panels. In most applications, the cable connections to the scanner will include:

1. CFG (Configuration via laptop Ethernet cable)
2. HOST
3. ETH 1 (EBC scanner network)
4. ETH 2 (EBC scanner network)
5. POWER
6. I/O (Connects directly to the 25-pin D type connector on the CBX connection box)
7. ENC (PNP Encoder/Tachometer)
8. TRG (PNP Trigger/Photoelectric Sensor)
9. Water-tight connectors



Figure 39: SC5000 Bottom Panel Connectors

Complete installation information for the SC5000 Controller is available in the **SC5000 System Controller Reference Manual** available at www.datalogic.com.

3.16 GROUNDING

In order to avoid any problems with electrical noise that could negatively affect system function, make sure that:

1. The AC power cable coming into the PWR box is always provided with a Ground and connected to the proper connector (Protective Earth - PE).
2. The structure where the readers, controllers, encoders/tachometers, and photoelectric sensors are mounted is grounded to the conveyor or to the PE terminal inside the PWR.
3. The Shield wires from the Encoder/Tachometer and photoelectric sensor cables are connected to the proper *Shield* terminal in the CBX box.
4. Normally, steps 1 through 3 will guarantee proper function. In case of problems such as transmission of strange or wrong characters, devices stop working without any reason, or other unexpected behavior, try connecting the CBX or Controller Earth terminal to the PE terminal inside the PWR box.

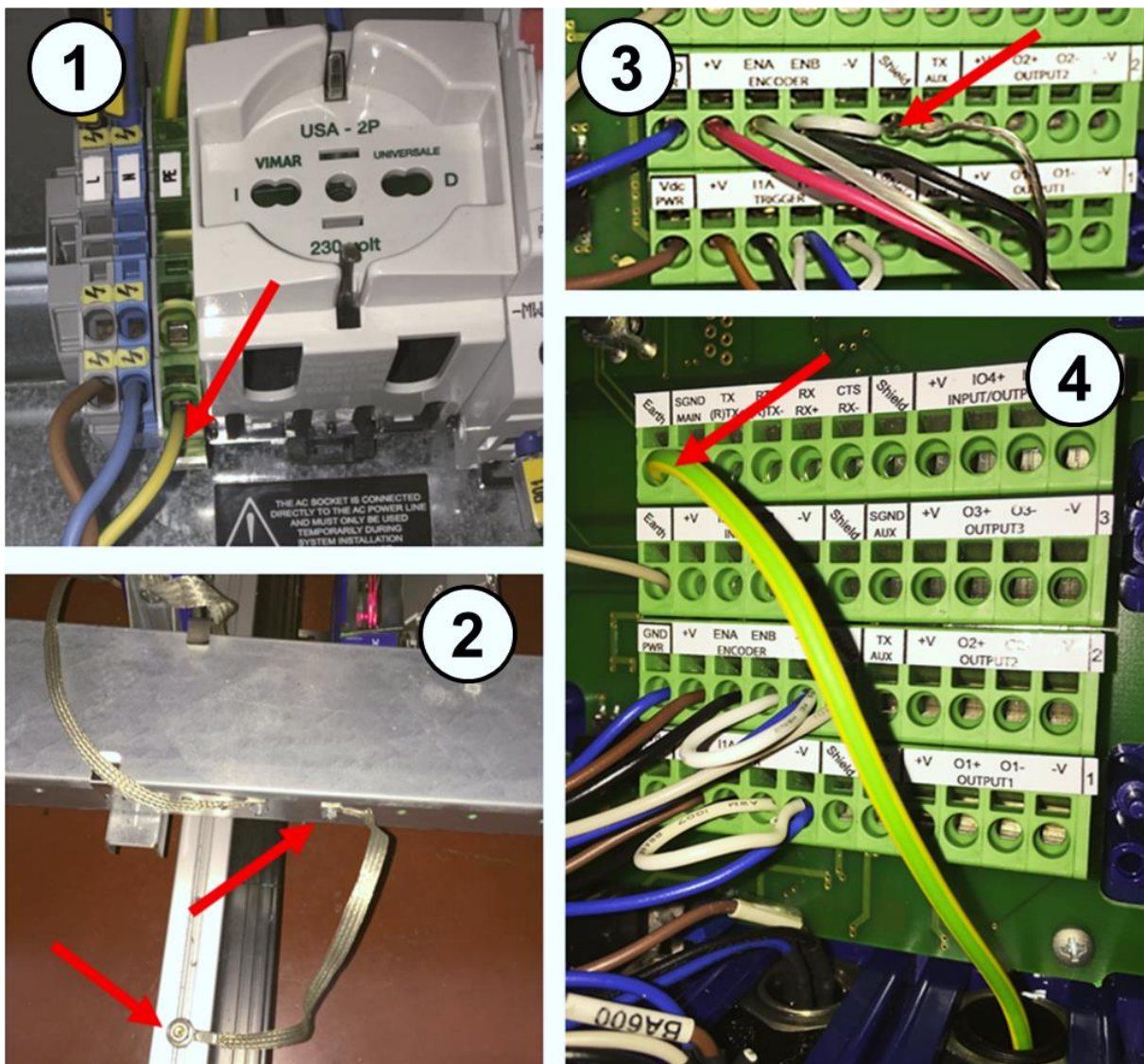

Figure 40: Grounding Examples

3.17 CHECK SCANNER INSTALLATION

After completing the installation of your barcode scanner, confirm that the barcode scanners, CBX connection box and/or SC5000 Controller have been properly installed mechanically and electrically. Use the Installation Sequence at the beginning of this chapter and your application specifications to check your installation.

4 E-GENIUS

4.1 GETTING STARTED

The **DS8110/DX8210** barcode scanners are designed for ease-of-setup. **e-Genius** is a browser-based application you will use to define operating parameters, monitor read quality, construct output messages, and view diagnostics. **e-Genius** enables you to easily configure, fine-tune, and monitor your scanner's operation.

e-Genius provides ease-of-use for any operator level.

4.1.1 Prerequisites

Before setting up your barcode scanner you will need the following:

| | |
|-----------------|---------------------------------|
| Computer | Laptop |
| Browser | Internet Explorer 11 (or later) |
| | Firefox 30 (or later) |
| | Chrome 36 (or later) |

4.1.2 Starting e-Genius

To access e-Genius:



NOTE: Before starting up or testing the scanner, it must be connected to a **CBX510 Connection Box** (see section 3.9) or an **SC5000 Controller** (see section 3.15) depending on the system configuration.

1. Connect your computer to the scanner's ETH 2 (setup) port using either the CAB-ETH-M0x M12-IP67 ETHERNET CABLE or CBL-1534-0.2 ADAPT.CABLE ETH M12-TO-RJ45F. If the ETH 2 (setup) port is taken, ETH 1 (host) can be used.
2. Turn on your computer.
3. If you are connecting to a stand-alone unit (not connected to an in-house network), you must configure your PC's IP Address to be in the same network as the scanner's (or if used, controller's) IP Address.

To change your PC's IP Address:

- a. From the desktop, click the **Start** button, and then select **Control Panel**.
 - b. Type **adapter** in the search box, and then from the results, under **Network and Sharing Center**, click **View network connections**.
 - c. Right-click **Local Area Connection** and then select **Properties**.
 - d. Select the **Networking** tab. Under **This connection uses the following items**, click **Internet Protocol Version 4 (TCP/IPv4)**, and then click **Properties**.
 - e. Select **Use the following IP address**.
 - f. In the **IP address** field, type the first 3 octets of the IP address of the reader/controller unit.
 - g. For the last octet, type a number that differs from the last octet in the reader/controller's IP address. The actual number used is not important as long as it does not match that of the reader/controller.
- Example:** If the barcode scanner's IP Address is 192.168.3.100, set your PC's IP Address to 192.168.3.101.
- h. In the Subnet mask field, type 255.255.255.0
 - i. Click **Okay**.
4. Open a web browser and enter the IP address for the DS8110/DX8210. If the correct IP address is entered, the DS8110/DX8210 **Log On** window will appear.

The default setup IP address for all **DS8110/DX8210** units is: 192.168.3.100 (setup/ETH2) and 172.27.101.220 (Host/ETH1).

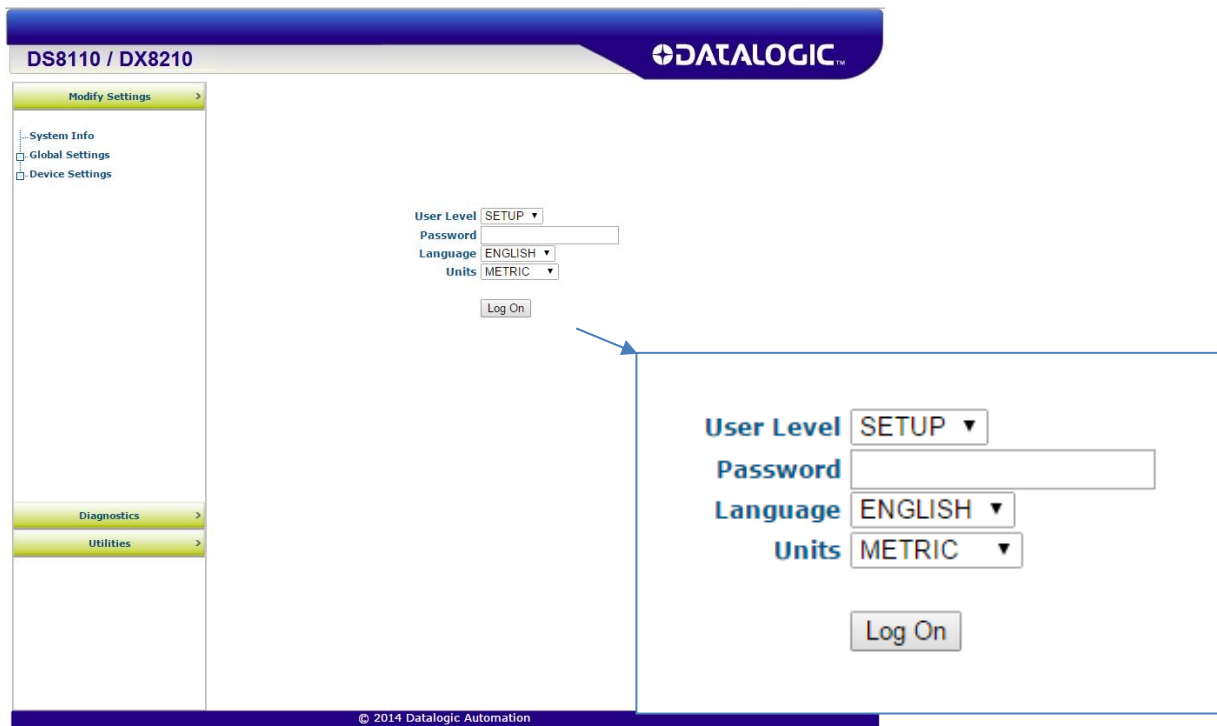

5. Enter the **Password** (default is DLA) for your system in the fields provided.
6. Select a language from those available in the **Language** drop-down list.
7. Select **METRIC** or **IMPERIAL** from the **Units** drop-down list.
8. Click **Log On**.

If the password is valid, the application enables all functions available to the user and displays the **System Info** window.

If the password is not valid, the application displays a results box with the message, **“Incorrect Password.”** Click **OK** to return to the **Log On** window and enter the correct user name and password. If you don't know the password, contact your system manager.

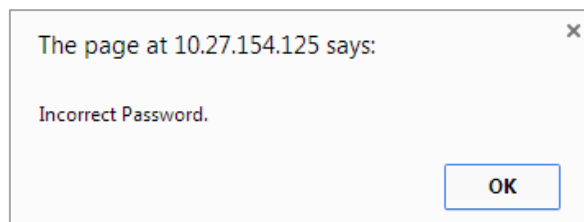

To log out of the e-Genius:

Click  at the upper right corner of the **e-Genius** window to Log Out. When logged out, the Log On window will appear.

4.2 E-GENIUS BASICS

4.2.1 e-Genius Menu Tree

The functions that you can select are displayed in a menu tree on the left-hand side of **e-Genius**. The function list is organized much like the hierarchy of a file system, where you can expand items that are preceded by a box (☐) to further sub-levels until you find a function of interest.

Sub-levels appear indented below the items from which they are expanded. Clicking the box again will collapse that branch of the menu. You can expand no further when an item is not preceded by a box.

The reader/controller **e-Genius** menu tree appears with no items expanded. Click the folders to display the active window for the setup function and/or expand the folders to view any additional setup features.

4.2.2 Entering Text Using the Text Entry Tool

In cases where text needs to be entered to create message headers, trailer, custom messages, or for other reasons, the **Text Entry Tool** pencil icon “✎” will be displayed.

Click ✎ to open the **Text Entry Tool**.

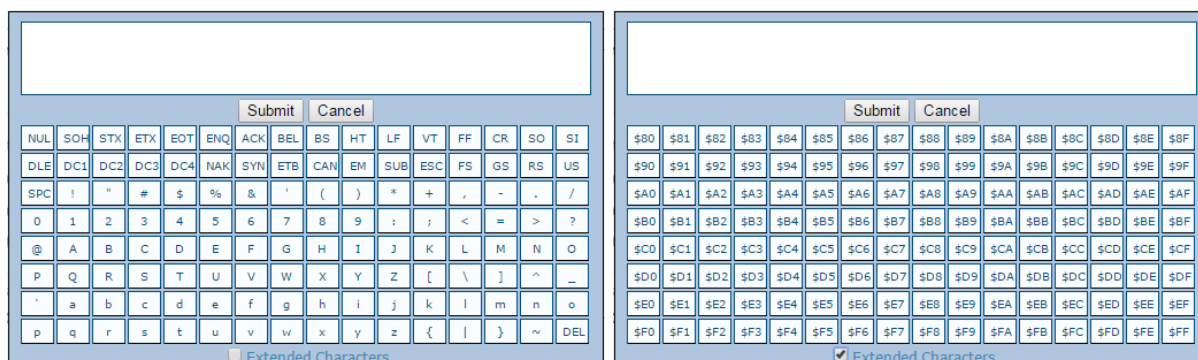

NOTE: The **Text Entry Tool** is needed to enter unprintable/untypable characters. For example, <CR> is a single character presented as a string for more easily reading.

The character must be entered with the tool, if typed normally it will be recognized as a string and not as a single character.

You can enter text in the text field by typing, or click on the character buttons to create your message. Select the **Extended Characters** check box to reveal a new set of control characters.

Click **Submit** to save your text to the origin window text field, or click **Cancel** to return to origin window without transferring text.

4.2.3 Update and Reset Buttons

The **Update All**, **Reset All**, and **Reset Page** buttons provide the following functions:

- **Update All:** Click to save all pending parameter changes (across active windows)
- **Reset All:** Click to revert all pending parameter changes (across active windows) to their last saved values
- **Reset Page:** Click to revert pending parameter changes on the current page to their last saved values

4.2.4 Getting Help

e-Genius provides complete online help.

To access the complete help system:

Select **Utilities | Help** in the **e-Genius** menu tree. The help **Welcome** window appears. The **Welcome** page provides important product information as well as three ways to find specific help information: **Contents**, **Index**, and **Search**.

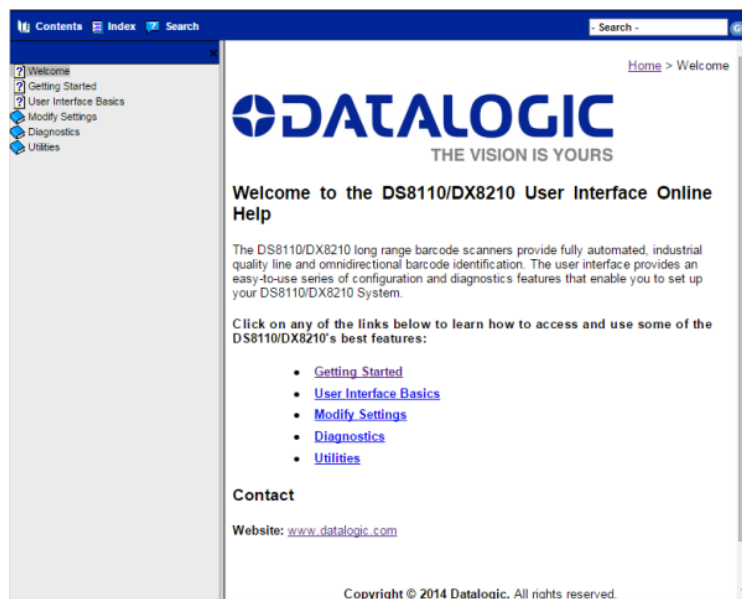

To display contextual help for a current window:

1. Click the **Help Icon**  displayed at the top right of the screen. A help window appears, providing you with information for that specific page.

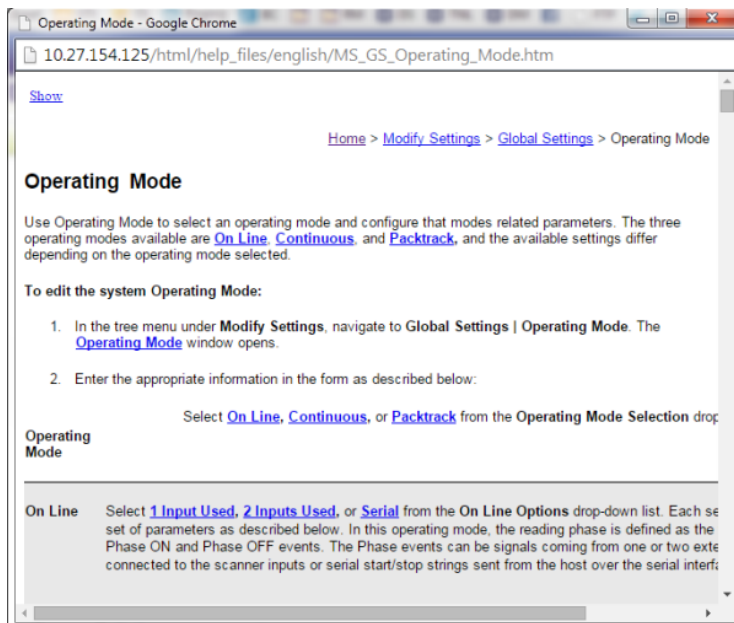

2. Click the **Show** link in the upper left corner of the help window to access Contents, Index, and Search options.

4.3 MODIFY SETTINGS

Use the Modify Settings Menu Tree selections during initial setup to configure your scanning system. If necessary, you can later make modifications to the configuration using the same menu selections.

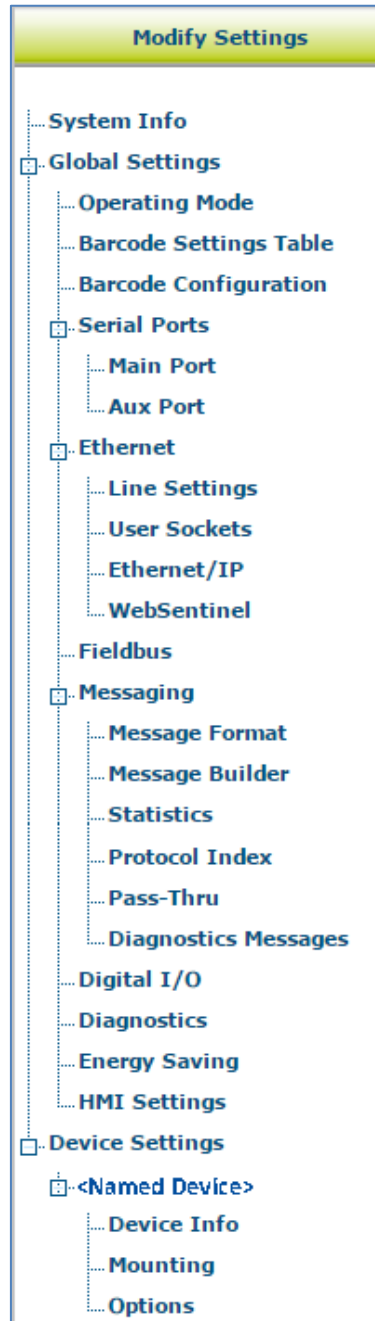

4.4 MODIFY SETTINGS | SYSTEM INFO

Use **System Info** to identify and name the scanning system (whether it includes one scanner or an array), indicate Master or Standalone systems, discover the scanners included in the system, and distribute software from the Master scanner to Slave scanners in the system.

To view and edit system information:

1. In the tree menu under **Modify Settings**, click System Info. The System Info window opens.

System Info

System Description

Role

Enable Automatic Slave Replace

Master Tools

Device Information

| Model | Dev | MAC Addr | Software Version | Description | |
|-------|-----|--------------|----------------------|--------------|----|
| | 0 | 0007BE0099C2 | ARM_release_v1_1_3_0 | Controller | |
| | 1 | 000E13040075 | ARM_release_v1_1_3_0 | DrumScanner | ID |
| | 2 | 0007BE00DAF6 | ARM_release_v1_1_3_0 | TableScanner | ID |
| | 3 | 000E13041212 | ARM_release_v1_1_3_0 | XScanner | ID |

Additional Devices

Send Barcodes to Non-Singulated Dimensioning System

Dimensioning System Info

IP Address

Port Number

Enable Tach Sync

2. Enter the appropriate information in the form as described below:

| Field Name | Action/Definition |
|---------------------------|---|
| System Info | |
| System Description | Enter a name to identify this scanning system in the text field. |
| Role | Select Standalone or Master from the drop-down list. Standalone (not controllers) indicates a scan point with a single barcode scanner. Master indicates that the system is made up of more than one barcode scanner in a master and slave configuration. |



NOTE: The SC5000 Controller will always be shown as Master and cannot be changed.

| Field Name | Action/Definition |
|---|---|
| Enable Automatic Slave Replace | <p>There are two ways to replace a defective scanner :</p> <ul style="list-style-type: none"> • If the check box is not selected: The replacement will be done only pressing the RESTORE (see section 5.5.2) key on the scanner or using the Edit drop-down. • If the check box is selected: The replacement will be completely automatic. This will work also as Hot-Automatic-Replacement without turning the system power off and on. |
| Force Operation as a Standalone/Master | Select the check box to allow a scanner to operate as a Master without a CBX attached. |
| Master Tools | These options are shown if Master is selected and is the default option for the SC5000 |

Discover Scanners Click **Discover Scanners** to automatically find all of the scanners in an array. The discovered scanners will be listed in the **Device Information** portion of the window. This step is only done during initial configuration and is not a troubleshooting option.



Distribute Software Click **Distribute Software** to send the current software residing on the master scanner to all of the slave scanners listed in the **Device Information** section of the window.

Device Information

Status

- Green** = No errors and ready to read
- Gray** = Unit not connected (unit not seen by master)
- Red** = Error. If you click on the red circle it will take you to the status viewer page for more info on the error

Model Displays an image of the scanner/controller model

Dev Displays the system designation for the device

MAC Address Displays the MAC Address (Media Access Control Address) for the device

Software version Displays the device installed software version.

Description Enter a user-defined description of the device.

ID Click **ID** to visually identify a scanner in an array/tunnel. When clicked, all the scanner lasers will turn off except for the selected scanner, whose laser will blink for 20 seconds.

| Field Name | Action/Definition |
|-------------|---|
| Edit | <p>Select to Remove, Reassign, Add, or Replace from the Edit drop-down list to complete the following actions:</p> <ul style="list-style-type: none"> • Remove: When selected, you can select the scanner to remove from the Dev/MAC Address drop-down list. Click OK to remove the selected scanner from the system. • Reassign: When selected, the Dev column of the selected slave scanner (selected with ID) presents a drop-down list of Dev numbers. Select a different number to reassign the scanner. • Add: This is an option under the Edit drop-down list in the Unconfigured Devices section of the screen. Click OK to add the selected device to the system. • Replace: This is an option under the Edit drop-down list in the Unconfigured Devices section of the screen. When selected, you can select from a list of slave scanners (<i>Those with a gray indicator, meaning the unit is not connected</i>) in the system using MAC Address and Dev drop-down lists. Click OK to replace the selected scanner with the Unconfigured Device. |

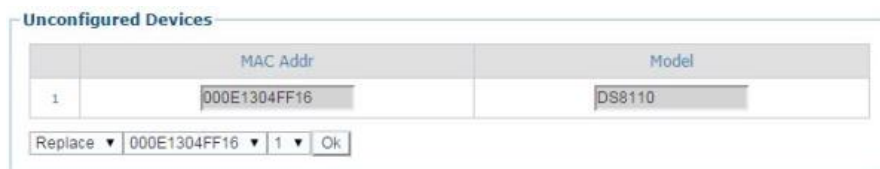

| Additional Devices | |
|--|--|
| Send Barcodes to Non-Singulated Dimensioning System | Select the checkbox to enable Non-Singulated Dimensioning System Info options. (currently not available for Standalone or Multi-head DM3610 systems) |
| IP Address | Enter the device IP Address. |
| Port Number | Enter a port number for the device. |
| Enable Tach Sync | Select the checkbox to enable encoder/tachometer syncing between system devices. |

3. When you have finished making changes, click **Update All** to save all pending changes, click **Reset All** to revert to all previously saved values, and click **Reset Page** to revert to previous saved values on the current page.

4.5 MODIFY SETTINGS | GLOBAL SETTINGS

Use the Global Settings menu tree selections during initial setup to configure your **DS8110/DX8210 Barcode Scanning System**. Global settings are applied to the system Master, and then distributed by the Master Scanner to the Slave devices. If necessary, you can later make modifications to the global system settings using the same menu selections.

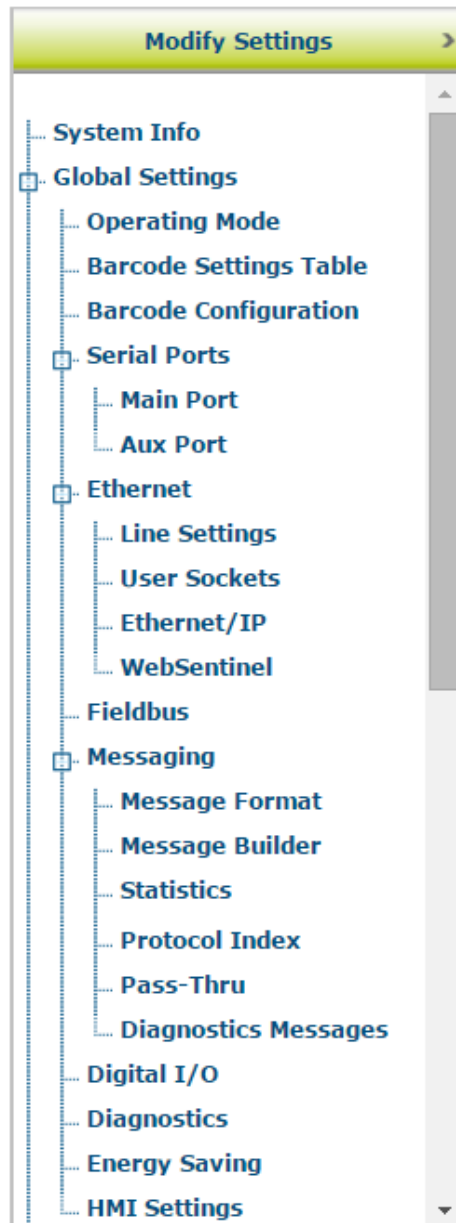

4.5.1 Modify Settings | Global Settings | Operating Mode

Use Operating Mode to select an operating mode and configure that modes related parameters. The three operating modes available are **On Line**, **Continuous**, and **PackTrack**, and the available settings differ depending on the operating mode selected.

To edit the system Operating Mode:

1. In the tree menu under **Modify Settings**, navigate to **Global Settings | Operating Mode**. The Operating Mode window opens.

Operating Mode

Operating Mode Selection: On Line

On Line Options: 1 Input Used

Trigger Source

Start Input Number: Trigger (Input 1)

Start Input Active Level: Active Open

Reading Phase Timeout:

Timeout (ms): 500 msec

Timeout Counting From: Stop

Verifier Settings

Verifier Enable:

Verifier Code:

Store Input: Aux (Input 3)

Active Level: Active Closed

Wrong Code Tx:

Wrong String Tx:

Wrong String(max. 128 chars): WRONGCODE

Beam Shutter Settings

Beam Shutter: Disabled

Update All Reset All Reset Page

2. Enter the appropriate information in the form as described below:

| Field Name | Action/Definition |
|-----------------------|---|
| Operating Mode | Select On Line , Continuous , or PackTrack from the Operating Mode Selection drop-down list. |
| On Line | Select 1 Input Used , 2 Inputs Used , or Serial from the On Line Options drop-down list. Each selection has a different set of parameters as described below. In this operating mode, the reading phase is defined as the time between the Phase ON and Phase OFF events. The Phase events can be signals coming from one or two external presence sensors connected to the scanner inputs or serial start/stop strings sent from the host over the serial interface or Ethernet input. |

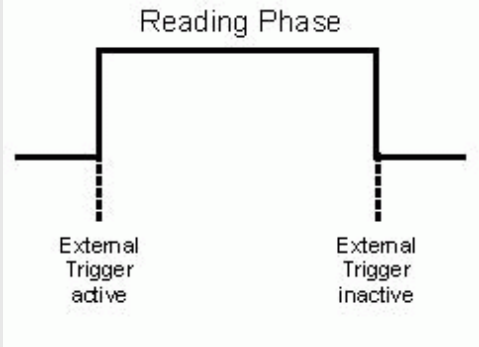

1 Input Used The reading phase takes place during the active phase of the presence sensor, when the scanner tries to acquire and correctly decode the code. If the operation is successful, the barcode characters are transmitted on the serial interface or Ethernet input in the format defined by the current configuration and the right output event is raised at the end of the photoelectric sensor's active phase. If a code cannot be decoded, a no read message is sent and the no read event is raised at the end of the photoelectric sensor's active phase.

Trigger Source

Start Input from Bus This parameter is available only for Fieldbus Hosts and if checked, allows the Fieldbus Master to drive the Reading Phase.

For Profinet or Profibus interfaces, it allows the Fieldbus Master to drive the reading phase via bit 7 in Byte 0 (LSB) of the Output Area.

For Ethernet/IP, it allows the Ethernet/IP Client to drive the reading phase via bit 7 in Byte OutputBits of the DL_OutputStruct.

Start Input Active Level Select **Active Open** or **Active Closed** from the drop-down list.

- **Active Open:** The input is active when there is no current flowing through IN pins. The input from the trigger source is normally closed. The scanner goes into trigger mode when the input source is opened.

| Field Name | Action/Definition |
|------------------------------|--|
| | <ul style="list-style-type: none"> • Active Closed: The input is active when current flows through IN pins. The input from the trigger source is normally opened. The scanner goes into trigger mode when the input source is closed. |
| Reading Phase Timeout | Select the check box to define a timeout for the On Line Serial mode and the On Line 1 Input mode. |
| Timeout (ms) | Enter a timeout in milliseconds (from 40 to 15000 ms) in the field provided. The Timeout represents the period of time for the reading phase. |
| Timeout Counting From | <p>Select Start or Stop from the drop-down list.</p> <ul style="list-style-type: none"> • When Start is selected, the Timeout used to determine the reading phase will begin from the Start Input or Serial Start String (normal operation) • When Stop is selected, the Timeout used to determine the reading phase will begin from the Stop Input or Serial Stop String (effectively extending the reading phase). |
| Verifier Settings | |
| Verifier Enable | Select the check box to enable the Code Verifier operating mode. |
| Verifier Code | Click  to activate the Text Entry Tool and create the string text used as the match code to the decoded codes. Use characters from NUL (00H) to ~ (7EH). Click Submit to save your text to the origin window text field, or click Cancel to return to origin window without transferring text. |
| Store Input | Select an option from the drop-down list to define the number of the input used to automatically store the verifier code. This input must be activated before the reading phase starts, the verifier code must be read and then after the end of the reading phase the input must be deactivated. |
| Active Level | <p>Select Active Open or Active Closed from the drop-down list to choose the active state of the input.</p> <ul style="list-style-type: none"> • Active Open: The input is active when there is no current flowing through IN pins. The input from the verify mode source is normally closed. The scanner goes into trigger mode when the input |

| Field Name | Action/Definition |
|------------|-------------------|
|------------|-------------------|

source is opened.

- **Active Closed:** The input is active when current flows through IN pins. The input from the verify mode source is normally opened. The scanner goes into trigger mode when the input source is closed.

| | |
|----------------------|---|
| Wrong Code Tx | Select the check box to enable the transmission of the Wrong Code (Non-Valid Code). |
|----------------------|---|

| | |
|------------------------|---|
| Wrong String Tx | Select the check box to enable the transmission of the Wrong String (Non-Valid String) message. |
|------------------------|---|

| | |
|--------------------------------------|--|
| Wrong String (max. 128 chars) | Enter a text string to be sent in case of a mismatch (wrong code read/non-valid code). |
|--------------------------------------|--|

| |
|------------------------------|
| Beam Shutter Settings |
|------------------------------|

| | |
|---------------------|---|
| Beam Shutter | Select Disabled , Triggered , or Enabled from the drop-down list. The Beam Shutter turns the laser off. The Beam Shutter option can be used to increase the overall laser diode life when used in high ambient temperature applications (over 35° C); reduce power consumption; and to turn off the laser for safety purposes. |
|---------------------|---|

- **Disabled:** The laser is always on.
- **Triggered:** The laser is turned off as soon as the code(s) are read or when the reading phase ends. The laser is turned on again when the next reading phase starts.
- **Enabled:** The laser is always off and all operations are suspended.

| | |
|----------------------|---|
| 2 Inputs Used | The reading phase is defined by 2 inputs. It starts when the Start Input is activated and stops when the Stop Input is deactivated (unless the Extended Phase is enabled). |
|----------------------|---|

| |
|-----------------------|
| Trigger Source |
|-----------------------|

| | |
|-----------------------|---|
| Extended Phase | Available only for the On Line/2 Inputs option. If checked, it allows the Stop Input to end the reading phase only if the Start Input is also deactivated. |
|-----------------------|---|

| | |
|---------------------------|---|
| Start Input Number | Select an input from the drop-down list to define the number of the input starting the reading phase. |
|---------------------------|---|

| Field Name | Action/Definition |
|---------------------------------|--|
| Start Input Active Level | <p>Select Active Open or Active Closed from the drop-down list.</p> <ul style="list-style-type: none"> • Active Open: The input is active when there is no current flowing through IN pins. The input from the trigger source is normally closed. The scanner goes into trigger mode when the input source is opened. • Active Closed: The input is active when current flows through IN pins. The input from the trigger source is normally opened. The scanner goes into trigger mode when the input source is closed. |
| Stop Input Number | Select an input from the drop-down list to define the input ending the reading phase. |
| Stop Input Active Level | <p>Select Active Open or Active Closed from the drop-down list to define the active state of the input.</p> <ul style="list-style-type: none"> • Active Open: The input is active when there is no current flowing through IN pins. The input from the trigger source is normally closed. The scanner goes into trigger mode when the input source is opened. • Active Closed: The input is active when current flows through IN pins. The input from the trigger source is normally opened. The scanner goes into trigger mode when the input source is closed. |
| Reading Phase Timeout | If checked, it allows defining a timeout for the Serial On Line mode and the On Line 1 Input mode. |
| Stop Phase Edge | <p>Select Trailing or Leading from the drop-down list to define the signal edge of the stop input used by the scanner as reference for ending the reading phase:</p> <ul style="list-style-type: none"> • Trailing: The reading phase ends when the package has completely passed by the stop input. • Leading: The reading phase ends as soon as the stop input detects the front edge of the package. |

| Field Name | Action/Definition |
|------------|-------------------|
|------------|-------------------|

| |
|------------------------------|
| Beam Shutter Settings |
|------------------------------|

| | |
|---------------------|--|
| Beam Shutter | <p>Select Disabled, Triggered, or Enabled from the drop-down list. The Beam Shutter turns the laser off. The Beam Shutter option can be used to increase the overall laser diode life when used in high ambient temperature applications (over 35° C); reduce power consumption; and to turn off the laser for safety purposes.</p> <ul style="list-style-type: none"> • Disabled: The laser is always on. • Triggered: The laser is turned off as soon as the code(s) are read or when the reading phase ends. The laser is turned on again when the next reading phase starts. • Enabled: The laser is always off and all operations are suspended. |
|---------------------|--|

| | |
|---------------|--|
| Serial | <p>In Serial/On-Line mode the reading phase starts when the Serial Start String is received on the serial interface and ends when the Serial Stop String is received or when a programmed Reading Phase Timeout expires.</p> <p>If decoding is correct, the data is transmitted on the serial port as defined by the configuration. The output line selected for the right output event is activated and the relative message is transmitted on the serial interface or Ethernet input.</p> <p>In case of a bad read, a no read message is transmitted on the serial interface. The output line selected for the no read event is activated and the relative message is transmitted on the serial interface or Ethernet input.</p> |
|---------------|--|

| |
|-----------------------|
| Trigger Source |
|-----------------------|

| | |
|--|--|
| Serial Start String (max. 32 chars) | <p>Click  to activate the Text Entry Tool and create the string text used to signal the beginning of the reading phase. Use characters from NUL (00H) to ~ (7EH). Click Submit to save your text to the origin window text field, or click Cancel to return to origin window without transferring text.</p> <p>The Serial Start string must be different from the Serial Stop string and Motor ON/OFF strings. When ACK/NAK Protocol or Energy Saving is enabled, the Serial Start/Stop Strings cannot contain ACK/NAK characters.</p> |
|--|--|

| Field Name | Action/Definition |
|---|--|
| Serial Stop String (max. 32 chars) | <p>Click  to activate the Text Entry Tool and create the string text used to signal the end of the reading phase. Use characters from NUL (00H) to ~ (7EH). Click Submit to save your text to the origin window text field, or click Cancel to return to origin window without transferring text.</p> <p>The Serial Stop string must be different from the Serial Start string and Motor ON/OFF strings. When ACK/NAK Protocol or Energy Saving is enabled, the Serial Start/Stop Strings cannot contain ACK/NAK characters.</p> |
| Reading Phase Timeout | Select the check box to define a timeout for the Serial On Line mode . |
| Timeout (ms) | Enter a timeout in milliseconds (from 40 to 15000 ms) in the field provided. The Timeout represents the period of time for the reading phase. |
| Timeout Counting From | <p>Select Start or Stop from the drop-down list.</p> <ul style="list-style-type: none"> When Start is selected, the Timeout used to determine the reading phase will begin from the Start Input or Serial Start String (normal operation) When Stop is selected, the Timeout used to determine the reading phase will begin from the Stop Input or Serial Stop String (effectively extending the reading phase). |
| Beam Shutter Settings | |
| Beam Shutter | <p>Select Disabled, Triggered, or Enabled from the drop-down list. The Beam Shutter turns the laser off. The Beam Shutter option can be used to increase the overall laser diode life when used in high ambient temperature applications (over 35° C); reduce power consumption; and to turn off the laser for safety purposes.</p> <ul style="list-style-type: none"> Disabled: The laser is always on. Triggered: The laser is turned off as soon as the code(s) are read or when the reading phase ends. The laser is turned on again when the next reading phase starts. Enabled: The laser is always off and all operations are suspended. |

| Field Name | Action/Definition |
|-------------------|---|
| Continuous | The reading phase is always active and allows reading two or more codes when placed along the same scan line. Code transmission is identical to the other operating modes except that there is no transmission on the serial port in case of a No Read condition. |

Mode Setting

Code Filter Select **Disable**, **Timeout**, **Encoder Steps**, or **Tx Line** from the **On Line Options** drop-down list. This parameter determines criteria for flushing entries from the code filtering list depending on the type of list management:

- The **Code Filter Depth** parameter, when not = 0, manages a FIFO (First In First Out) list of codes which are compared for filtering. The **Timeout** and **Encoder Steps** values are in addition to the cyclical flushing of entries when the FIFO list depth is exceeded.
- When **Code Filter** is set to **Tx Line** an internal list is managed where each entry is flushed when the **Tx Line** distance is exceeded.

The application program inherently compares codes based on content and code length.

Each Code Filter criteria has its own relative value parameter.

- **Disable:** No additional criteria are applied. If code filtering is enabled through the Code Filter Depth parameter, the FIFO list is only modified by new code entries (FIFO list depth exceeded).
- **Timeout:** A timeout measured in milliseconds is also applied to each code entry. The current code entry will be flushed from the list when the timeout expires.
- **Encoder Steps:** a threshold measured in encoder steps is also applied to each code entry. The current code entry will be flushed from the list when the number of encoder steps is exceeded.
- **Tx Line:** The distance measured in mm to the transmit line is applied to each code entry. The current code entry will be flushed from the list when the distance in mm is exceeded. When Tx Line is selected, all the networked scanners must have been calibrated using PackTrack (See section 5.7 PackTrack).



NOTE: When Code Filter = Tx Line:

The Code Filter Depth parameter is no longer available because the application program manages an internal list which depends solely on the number of codes decoded before the Tx Line is reached.

Any code which is determined to be identical to

| Field Name | Action/Definition | | | | | | | | | | | | | | | | | | | | | | | | |
|---|---|----------|-----------|----------|------------------------|---|-----|-----|---|-----|-----|---|----|-----|---|-----|-----|---|-----|-----|---|-----|-----|---|----|
| | <p>a code in the list by comparing the filter conditions will be discarded, and to increase precision the code in the list will have its x, y, z position coordinates adjusted as the average between the two readings.</p> $x=x_1+x_2/2, y=y_1+y_2/2, z=z_1+z_2/2$ | | | | | | | | | | | | | | | | | | | | | | | | |
| Code Filter Depth | <p>In Continuous mode, Code Filter Depth is used to avoid multiple reads of the same code. The entered value (other than zero) defines the number of codes to memorize in a FIFO (First In First Out) list.</p> <p>When a code is read, it is compared to the list. The application program inherently compares codes based on content and code length. If the list contains a code identical to the current code being read, the current code is discarded. If not, the current code is accepted and added to the list in the first position; the remaining codes in the list are shifted. If the list is full the oldest code in the list will be flushed.</p> <p>When = 0, there is no FIFO list and there is no filtering.</p> <p>Selection: a value from 0 to 127</p> <p>Example:</p> <p>Code Filter Depth = 3</p> <table border="1"> <thead> <tr> <th>List</th> <th>Code Read</th> <th>Accepted</th> </tr> </thead> <tbody> <tr> <td>xxx (no codes in list)</td> <td>A</td> <td>Yes</td> </tr> <tr> <td>Axx</td> <td>B</td> <td>Yes</td> </tr> <tr> <td>BAx</td> <td>B</td> <td>No</td> </tr> <tr> <td>BAx</td> <td>C</td> <td>Yes</td> </tr> <tr> <td>CBA</td> <td>D</td> <td>Yes</td> </tr> <tr> <td>DCB</td> <td>A</td> <td>Yes</td> </tr> <tr> <td>ADC</td> <td>A</td> <td>No</td> </tr> </tbody> </table> | List | Code Read | Accepted | xxx (no codes in list) | A | Yes | Axx | B | Yes | BAx | B | No | BAx | C | Yes | CBA | D | Yes | DCB | A | Yes | ADC | A | No |
| List | Code Read | Accepted | | | | | | | | | | | | | | | | | | | | | | | |
| xxx (no codes in list) | A | Yes | | | | | | | | | | | | | | | | | | | | | | | |
| Axx | B | Yes | | | | | | | | | | | | | | | | | | | | | | | |
| BAx | B | No | | | | | | | | | | | | | | | | | | | | | | | |
| BAx | C | Yes | | | | | | | | | | | | | | | | | | | | | | | |
| CBA | D | Yes | | | | | | | | | | | | | | | | | | | | | | | |
| DCB | A | Yes | | | | | | | | | | | | | | | | | | | | | | | |
| ADC | A | No | | | | | | | | | | | | | | | | | | | | | | | |
| Filter Number of Encoder Steps | <p>Enter a number of encoder steps from 1 to 1500. This parameter sets the number of Encoder Steps after which the FIFO (First In First Out) list entry is flushed.</p> | | | | | | | | | | | | | | | | | | | | | | | | |
| Replicate same code when symbologies don't match | <p>Select the check box to enable a further code filter condition according to which a read code is added to the list or discarded. This parameter is available if the Code Filter Depth value is other than zero or if the Code Filter value is Tx Line.</p> <p>In addition to the inherent content and code length comparison, this parameter compares the code type (symbology). If the current code being read is identical to any code contained in the list by: content, length and type, the current code is discarded. If not, the current code is accepted and added to the list in the first position; the remaining codes in the list are shifted. If the list is full the oldest code in the list will be flushed.</p> | | | | | | | | | | | | | | | | | | | | | | | | |

| Field Name | Action/Definition |
|---|--|
| Replicate same code when X positions don't match | <p>Select the check box to enable a further code filter condition according to which a read code is added to the list or discarded. This parameter is available if the Code Filter Depth value is other than zero or if the Code Filter value is Tx Line.</p> <p>In addition to the inherent content and code length comparison, this parameter compares the X coordinate code position. If the current code being read is identical to any code contained in the list by: content, length and X coordinate code position, the current code is discarded. If not, the current code is accepted and added to the list in the first position; the remaining codes in the list are shifted. If the list is full the oldest code in the list will be flushed.</p> |
| Replicate same code when Y positions don't match | <p>Select the check box to enable a further code filter condition according to which a read code is added to the list or discarded. This parameter is available if the Code Filter Depth value is other than zero or if the Code Filter value is Tx Line.</p> <p>In addition to the inherent content and code length comparison, this parameter compares the Y coordinate code position. If the current code being read is identical to any code contained in the list by: content, length and Y coordinate code position, the current code is discarded. If not, the current code is accepted and added to the list in the first position; the remaining codes in the list are shifted. If the list is full the oldest code in the list will be flushed.</p> |
| Replicate same code when Z positions don't match | <p>Select the check box to enable a further code filter condition according to which a read code is added to the list or discarded. This parameter is available if the Code Filter Depth value is other than zero or if the Code Filter value is Tx Line</p> <p>In addition to the inherent content and code length comparison, this parameter compares the Z coordinate code position. If the current code being read is identical to any code contained in the list by: content, length and Z coordinate code position, the current code is discarded. If not, the current code is accepted and added to the list in the first position; the remaining codes in the list are shifted. If the list is full the oldest code in the list will be flushed.</p> |
| Continuous Threshold (number of scans) | <p>Enter an <i>N</i> number of scans without a code allowed in order to assure code identification in the reading zone. Enter a value from 10 to 32665.</p> |
| Encoder Settings | |
| Encoder Source | <p>Select Constant Speed (Internal) or Physical Encoder (Tachometer) from the drop-down list:</p> <ul style="list-style-type: none"> • Constant Speed (Internal): Allows the user to specify the tach rate to be used (from .05 - 3.05 m/sec [from 10 - 600 ft/min]). No external hardware is used. • Physical Encoder (Tachometer): A physical encoder is connected to the Encoder input and is enabled |

| Field Name | Action/Definition |
|--|--|
| Encoder Step (hundredths of millimeter) | Enter the step value of the encoder. See <i>section 1.8.1</i> for a table of Encoder Step values. |
| Conveyor Speed (mm/sec) | This parameter is available only when the Physical Encoder is disabled. It defines the constant speed of the conveyor in mm/sec. |
| PackTrack | Refer to <i>section 5.7</i> for physical PackTrack installation procedures. |
| Trigger Source | |
| Start Input from Bus | <p>This parameter is available only for Fieldbus Hosts and if checked, allows the Fieldbus Master to drive the Reading Phase.</p> <p>For Profinet or Profibus interfaces, it allows the Fieldbus Master to drive the reading phase via bit 7 in Byte 0 (LSB) of the Output Area.</p> <p>For Ethernet/IP, it allows the Ethernet/IP Client to drive the reading phase via bit 7 in Byte OutputBits of the DL_OutputStruct.</p> |
| Start Input Number | Select an input from the drop-down list to define the number of the input starting the reading phase. |
| Start Input Active Level | <p>Select Active Open or Active Closed from the drop-down list to define the active state of the input.</p> <ul style="list-style-type: none"> • Active Open: The input is active when there is no current flowing through IN pins. The input from the trigger source is normally closed. The scanner goes into trigger mode when the input source is opened. • Active Closed: The input is active when current flows through IN pins. The input from the trigger source is normally opened. The scanner goes into trigger mode when the input source is closed. |
| Transmission Edge | <p>Select Trailing or Leading from the drop-down list to define the signal edge of the stop input used by the scanner as reference for ending the reading phase:</p> <ul style="list-style-type: none"> • Trailing: The reading phase ends when the pack has completely passed by the stop input. • Leading: The reading phase ends as soon as the stop input detects the front edge of the pack. |

| Field Name | Action/Definition |
|------------|-------------------|
|------------|-------------------|

Mode Setting

Distance from PS Line to Tx Line Enter the distance along the Y axis from the PS (photoelectric sensor) to the **TX Line** (transmit).

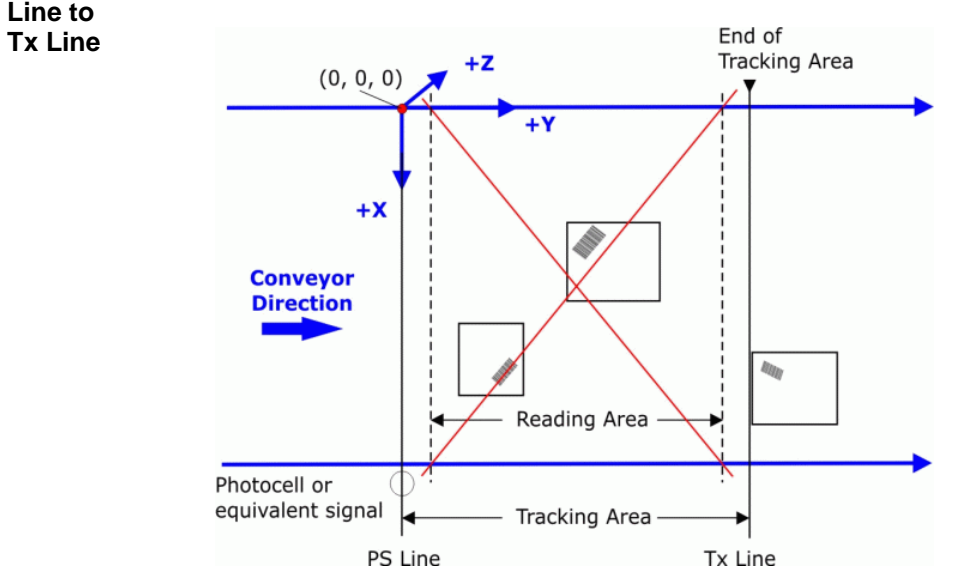

NOTE: Tracking starts 10 cm [4 inches] before and stops 10 cm [4 inches] after the Reading Area in order to ensure the barcode is assigned to the correct package.

PS Line This parameter defines the read signal Y coordinate (mm) referred to the origin of co-ordinates used for PackTrack configuration (see below).

Example:

- Normally the PS Line coincides with the PackTrack reference where X, Y, Z = 0.
- If the presence sensor (photocell or Host PS signal) is moved, you must set the PS Line accordingly and recalculate the Tx Line.
- 1. PS Line = 0; Distance from PS Line to Tx Line = 2500
- 2. PS Line = 500; Distance from PS Line to Tx Line = 2000

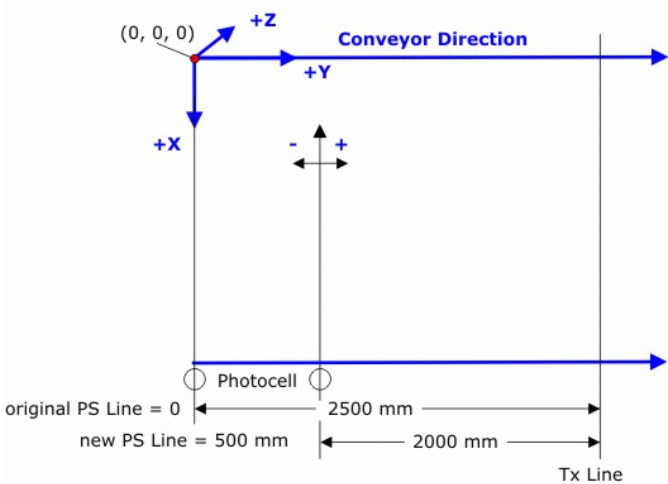

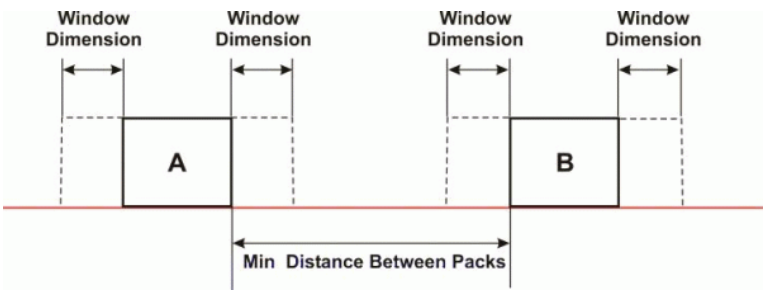
| Field Name | Action/Definition |
|--|---|
| Minimum Pack Length | Enter the minimum length of a pack in the space provided (mm [in]). |
| Minimum Distance Error Behavior | Select Ignore Error , Compose , or Discard Last from the drop-down list. <ul style="list-style-type: none"> • Ignore Error: the error is ignored • Compose: Enter the Minimum Distance Between Packages in the field provided. • Discard Last: discards all received packages |
| Minimum Distance Between Packages | Enter the minimum distance (mm, in) between consecutive packages. This field is only available when Compose or Discard Last is selected for the Minimum Distance Error Behavior . |
| Window Dimension | Enter a Window Dimension in the field provided. <p>The measurement of a barcode position in absolute coordinates performed by the scanners may be affected by an error. PackTrack evaluation can fail in assigning the barcode for this reason. With the Window Dimension parameter, the Y coordinates that delimit the pack can be virtually extended to improve the assigning success rate (see the following figure).</p> <p>If the minimum distance between two consecutive packs is less than twice the value of the Window Dimension, the window is dynamically resized (dynamic window) to half the distance between the two packs. The code will be assigned within the Window Dimension of the closest pack.</p> <p>If the minimum distance between two consecutive packs is more than twice the value of the Window Dimension, the code will be assigned within the Window Dimension itself.</p>  |
| Encoder Settings | |
| Physical Encoder | Select Disable or Enable from the drop-down list: <ul style="list-style-type: none"> • Disable: No encoder is enabled • Enable: A physical encoder is connected to the Encoder input and is enabled |

| Field Name | Action/Definition |
|--|---|
| Encoder Step (hundredths of millimeter) | Enter the step value of the encoder. See <i>section 1.8.1</i> for a table of Encoder Step values. |
| Conveyor Speed (mm/sec) | This parameter is available only when the Physical Encoder is Disabled . It defines the constant speed of the conveyor in mm/sec. |
| Beam Shutter Settings | |
| Beam Shutter | Select Disabled , Triggered , or Enabled from the drop-down list. The Beam Shutter turns the laser off. The Beam Shutter option can be used to increase the overall laser diode life when used in high ambient temperature applications (over 35° C); reduce power consumption; and to turn off the laser for safety purposes. <ul style="list-style-type: none"> • Disabled: The laser is always on. • Triggered: The laser is turned off as soon as the code(s) are read or when the reading phase ends. The laser is turned on again when the next reading phase starts. • Enabled: The laser is always off and all operations are suspended. |
| PackTrack Beam Shutter Timeout | Select a time value from the drop-down list. This parameter is available only when Operating Mode = PackTrack and Beam Shutter = Triggered . By setting this parameter the laser is turned off as soon as the selected timeout expires. |

- When you have finished making changes, click **Update All** to save all pending changes, click **Reset All** to revert to all previously saved values, and click **Reset Page** to revert to previous saved values on the current page.

4.5.2 Modify Settings | Global Settings | Barcode Settings Table

Use **Barcode Settings Table** to select and configure barcodes to be read in your application. Each barcode type

To edit the **Barcode Settings**:

1. In the tree menu under Modify Settings, navigate to **Global Settings | Barcode Settings Table**. The **Barcode Settings** window opens.

| Idx | Symbology | Minimum Length | Maximum Length |
|-----|-----------|----------------|----------------|
| 1 | Code 128 | 10 | 12 |
| 2 | Code 39 | 4 | 40 |
| 3 | EAN-13 | 13 | No Add On |
| 4 | UPC-A | 12 | No Add On |
| 5 | Disabled | | |

Barcode 1

Enable

Code Symbology: Code 128

Minimum Label Length: 10

Maximum Label Length: 12

Match String Rule: Match

Pattern Match String:

Options

Decoding Safety: 1



Bar Count: Variable

Match Direction Rule: Disable

Update All Reset All Reset Page

2. Enter the appropriate information in the form as described below:

| Field Name | Action/Definition |
|-----------------------|--|
| Top Panel | Displays a list of barcodes that have been added to the system with the following columns: |
| Idx | Select an option button for the row/barcode you wish to edit. <ul style="list-style-type: none"> • If a barcode type is displayed in the selected row, its configuration can then be edited. • If a row displaying disabled is selected, a barcode type can be selected and configured for that row. |
| Symbology | Displays the name of the barcode symbology for that row. If no symbology has been added for a row, disabled is displayed. |
| Minimum Length | Displays the minimum barcode character length for that row's symbology. |

| Field Name | Action/Definition |
|--|---|
| Maximum Length | Displays the maximum barcode character length for that row's symbology. |
| Barcode <i>n</i> |  NOTE: Input fields will vary depending on the selected symbology. |
| Enable | Select the Enable check box to activate the selected barcode. Deselect the Enable check box to disable the selected barcode. When the check box has been selected, configuration and code type options are displayed. |
| Code Symbology | Select a barcode symbology from those available in the Code Symbology drop-down list. |
| EAN Add On | Select No Add On , 2 digits Add On , or 5 digit Add On from the EAN Add On drop-down list. Selecting 2 digit Add On or 5 digit Add On adds that many digits as a supplement to the barcode. EAN is the acronym for International Article Number , previously known as European Article Number . |
| Minimum Label Length | Enter the minimum character length for the selected barcode. |
| Maximum Label Length | Enter the maximum character length for the selected barcode. |
| Match String Rule | Select Match or Do Not Match from the drop-down list. This parameter defines the matching rule, according to which a code can be transmitted. <ul style="list-style-type: none"> • Match: All codes matching the Pattern Match String will be transmitted • Do Not Match: All codes not matching the Pattern Match String will be transmitted |
| Pattern Match String (max. 200 chars) | Click  to activate the Text Entry Tool and create a pattern match string. A code can also be identified by its content. A pattern matching string is programmable for each code and if the read codes do not match the defined string, a No Read Event will be returned. <p>It is possible to define the matching string by inserting:</p> <ul style="list-style-type: none"> • all printable characters • non printable ASCII characters available in the list which appears by right-clicking on the parameter edit box • * = defining any string consisting of an undefined number of characters (it may be empty) • ? = identifying any character to be found in the position indicated within the string <p>If your application requires inserting ?, * and NUL as characters, it is necessary to use the following syntax:</p> <ul style="list-style-type: none"> • ? character = <NUL>? • * character = <NUL>* • NUL character = <NUL>00 • other extended ASCII characters = <NUL>xy, where xy identifies the character hex value |

| Field Name | Action/Definition |
|------------|-------------------|
|------------|-------------------|

Examples:**Match a code starting with 123 string and followed by any string of characters:**

- Match String = 123*
- Example Code = 123aC53

Match a code ending with 123 string preceded by any string of characters:

- Match String = *123
- Example Code = 41pO123

Match a code having 123 string in any position:

- Match String = *123*
- Example Code = 41pO123253

Match a code starting with 123 string followed by three generic characters and an undefined string of characters, in this case no character:

- Match String = 123???*
- Example Code = 123ad2

Match any code of four characters:

- Match String = ????
- Example Code = gT6k

Match a code with 6 characters in any position having 12 as central characters:

- Match String = *??12??*
- Example Code = data12og35

The following is an example of a very complex string where ? and* are used both as commands and as characters:

- Match String = *45<NUL>??*??AC<NUL>*251?*
- Example Code = GEN45?3iusdsAC*2516300



NOTE: For **Codabar** codes the start/stop characters must be considered in the match conditions.
For all codes which use check digits, if the **Check Digit** is transmitted, it must be considered in the match conditions.

Options

NOTE: Input fields will vary depending on the selected symbology.

Decoding Safety

Enter a number from **1** to **100** (1 = control disabled) in the field provided. It verifies that an *N* number of decodes are performed with the same result before code reading is accepted as valid.

| Field Name | Action/Definition |
|------------|-------------------|
|------------|-------------------|

| | |
|--------------------|---|
| Check Digit | Select the check box to improve decoding safety: it is generally the last digit aligned to the right of the code and verifies the validity of the preceding digits. The calculation technique and number of check digits depend on the code selected. |
|--------------------|---|

It is advised to enable the check digit whenever correct code identification is difficult. The following barcode symbologies include check digits in their definitions:

- Code 128
- EAN/UPC
- Code 93

For these symbologies the check digit control is not allowed.

| | |
|-------------------------|---|
| Check Digit Type | Select a customized check digit for Standard, German, DHL, Daimler-Chrysler, or Bosch from the drop-down list. |
|-------------------------|---|

| | |
|-----------------------|--|
| Check Digit Tx | Select the check box to include the Check Digit in the code transmitted. |
|-----------------------|--|

| | |
|------------------|---|
| Bar Count | Select Variable or an available value from the drop-down list. The Bar Count allows to further specify the number of elements in the read code for Code 128, GS1-128, Code 93, ISBT 128 or Code 39 Full ASCII. |
|------------------|---|

For these codes, the same number of barcode elements (bars + spaces) can be associated with a different number of characters.

- **Variable:** to select the correct number of characters, set Label Length to the desired fixed value and Bar Count to Variable



12
Code 128
Subset A



12
Code 128
Subset C

Digit Number 2, Bar Count variable

- **Code 128 or GS1-128:** from 25 to 499 - a variable number of characters in steps of 6.
- **Code 93 or ISBT 128:** from 25 to 385 - a variable number of characters in steps of 6.
- **Code 39 Full ASCII:** from 29 to 619 - a variable number of characters in steps of 10.

To select a particular barcode length in elements, set Bar Count to the desired fixed value and Label Length to Variable.



12
Code 128
Subset A



1234
Code 128
Subset C

Digit Number variable, Bar Count 31

| Field Name | Action/Definition |
|-----------------------------|--|
| Match Direction Rule | <p>Select Disable, Forward, or Reverse from the drop-down list. This parameter defines the direction, according to which a code can be transmitted. The direction refers to the code direction with respect to the scan line, in particular: Forward = the code start character precedes the stop character in the scan line (Start Ch + Code + Stop Ch); Reverse = the code stop character precedes the start character in the scan line (Stop Ch + Code + Start Ch)</p> <ul style="list-style-type: none"> • Disable: All codes are transmitted no matter what the direction is • Forward: All codes having a forward direction are transmitted • Reverse: All codes having a reverse direction are transmitted |
| Start Char Tx | <p>Select Disabled, Lower Case, or Upper Case from the drop-down list. This parameter is available only for Codabar code symbologies. It allows transmitting the code start character:</p> <ul style="list-style-type: none"> • Disabled: The character is not selected; • Lower Case: The character is transmitted in lower case; • Upper Case: The character is transmitted in upper case. |
| Stop Char Tx | <p>Select Disabled, Lower Case, or Upper Case from the drop-down list. This parameter is available only for Codabar code symbologies. It allows transmitting the code stop character:</p> <ul style="list-style-type: none"> • Disabled: The character is not selected; • Lower Case: The character is transmitted in lower case; • Upper Case: The character is transmitted in upper case. |

3. When you have finished making changes, click **Update All** to save all pending changes, click **Reset All** to revert to all previously saved values, and click **Reset Page** to revert to previous saved values on the current page.

4.5.3 Modify Settings | Global Settings | Barcode Configuration

Use **Barcode Configuration** to configure how the system defines a no read barcode, and configure and filter NOREAD messages.

To edit the Barcode Configuration:

1. In the tree menu under **Modify Settings**, navigate to **Global Settings | Barcode Configuration**. The **Barcode Configuration** window opens.

2. Enter the appropriate information in the form as described below:

| Field Name | Action/Definition |
|-------------------------|--|
| Code Combination | Select Single Label , Standard Multi Label , Logical Combination , or Code Collection from the drop-down list. The Code Combination parameter selects the decoding mode for the scanner. |

- **Single Label:** In this mode only one barcode can be read in each reading phase; however it can be determined automatically from up to 10 enabled codes. The scanner stops decoding as soon as a code is read.

If the code is not read during the reading phase, the No Read message is produced.

- **Standard Multi Label:** In Multi Label mode the barcodes selected (up to 10), will all be read in the same reading phase. If the reading phase terminates before all the codes are read, a Global No Read message will be produced, unless it is disabled, in which case a Local No Read will be produced.



NOTE: In case of Multi Label, the codes will be distinguished EITHER by their symbology, OR by their contents. If two (or more) codes share the same symbology and content, the scanner will perceive them as a unique code.

- **Logical Combination:** In Logical Combination mode the codes of the groups defined by the Logical Combination Rule are read in the same reading phase.
- **Code Collection:** In Code Collection mode expected codes are collected within a single reading phase in the order in which they are read. The No Read message is produced only if none of the codes are read. Up to 50 codes can be collected.

Barcode Configuration > Single Label

When **Single Label** has been selected from the **Code Combination** drop-down list, the Barcode Configuration window reveals related input fields.

Enter the appropriate information in the form as described below:

| Field Name | Action/Definition |
|---|--|
| Code Combination | Single Label has been selected. |
| No Read Message | <p>Select Disable No Read Message, Global No Read Message, or Local No Read(s) Message from the drop-down list. The No Read condition occurs whenever a code cannot be read or decoded.</p> <ul style="list-style-type: none"> • Disable No Read Message: The No Read Message is not transmitted. • Global No Read Message: The No Read String will be sent if the scanner is unable to decode one or more barcodes in the reading phase. • Local No Read(s) Message: Do not use this option when working in Single Label mode. |
| Use 'Global No Read String' when No Codes Read | Select the check box to allow the Global No Read String to be used if no codes at all are read. This option is not available when Global No Read Message is selected from the No Read Message drop-down list. |
| Global No Read String (max. 128 chars) | Click  to activate the Text Entry Tool and create a string to be displayed when Global No Read Message is selected from the No Read Message drop-down list. |
| Multi Filters | Select the check box to display the Multi-Filter Settings options. |

| Field Name | Action/Definition |
|------------------------------|-------------------|
| Multi-Filter Settings | |

Contained Filter Select the check box to reveal the **Max Number of Different Characters** field.

When checked, this filter attempts to eliminate false multiple reads by determining if a short code read is "contained in" (is a sub-string of), another longer code read. This condition implicates that the short code is probably a misread of the same longer code and therefore should be ignored, (should not be considered as a multiple read of a different code).

This filter is based upon the following rules:

- a multiple read condition occurs
- all decoded codes of the same type are compared with each other

Rule 1: the shorter code is considered contained in the longer code if the character string is found in the same order; the longer code may have a single block of characters in any position (before, after or in between the compared strings)

Example: The code **123456** is considered contained in the following codes: 00123456, 12345600, 12378456.

The code **123456** is not considered contained in the following codes: 1234**6507** (string out of order), 12345**700** (string not complete), 12**0378**456 or **00**123456**00** (multiple blocks in the string).

Rule 2: the shorter code is not filtered by rule 1. In the longer code, all possible sub-strings of the same length as the shorter code string are compared with the shorter code string. The shorter code is considered contained in the longer code if the number of different characters between the compared codes is less than or equal to the Max Number of Different Characters. The shorter code will be filtered by rule 2.

Example:

If Max Number of Different Characters = 1:

The code **123456** is considered contained in the following codes: **12305600**, **00123056**, **8812305688** because there is only one different character in the compared string.



The code **123456** is not considered contained in **123066789** because there are two different characters in the compared string.



CAUTION: If the **Contained Filter** parameter is used when **Message Tx Selection** (see *section 4.5.7*) is set to **On Decoding**, the filter conditions may be satisfied before the reading phase ends resulting in possible successive multiple read errors.

| Field Name | Action/Definition |
|---|---|
| Max Number of Different Characters | <p>Enter a value from 0 to 5 in the field provided to define the maximum number of different characters allowed to still consider a code as being included in another one and therefore to be filtered.</p> <p>If the number of different characters between the compared codes exceeds the value of this parameter, the codes are considered as different and will not be filtered (a multiple read of a different code occurs).</p> <p>If the number of different characters between the compared codes is less than or equal to the value of this parameter, the short code is considered as a sub-string of the longer code and will be filtered (no multiple read occurs).</p> <p>Examples:</p> <p>If Max Number of Different Characters = 2: The code 123456 read once, is considered the same as the following codes read multiple times: 133056, 123546, 123457 because there are two or less different characters by position in the compared codes.</p> <p>The code 123456 read once, is not considered the same as the following codes read multiple times: 153246, 103057, 654321 because there are at least three different characters by position in the compared codes.</p> |
| Voting Filter | <p>Select the check box to reveal the Max Number of Different Characters field.</p> <p>When checked, this filter attempts to eliminate false multiple reads by comparing the number of different characters by position between two codes of the same type and length. This condition implicates that reading a code of the same type and length having very few different characters is probably a misread of the code itself and therefore the code read the least number of times should be ignored, (should not be considered as a multiple read of a different code).</p> <p>This filter is based upon the following rules:</p> <ul style="list-style-type: none"> • a multiple read condition occurs; • the two codes are of the same type; • the two codes have the same length; • the number of different characters by position is equal to or less than the number defined by the Max Number of Different Characters parameter; • Message Tx Selection (see section 4.5.7) must be set to After Reading Phase Off. |
| Filter Out Low Height Codes | <p>Select the check box to reveal the Minimum Readings Difference Between Scanners field.</p> <p>Background: This option was developed for the airports systems where there are often tall bar height codes and low bar height codes with the same content attached to baggage. Travelers will often remove the large, tall bar height code, while leaving the smaller, low bar height codes attached to the bag. The next time they travel they may have multiple low bar height codes on their baggage plus the new tall bar height and low bar height codes for the new trip.</p> <p>This option instructs the system to ignore low bar height codes, which are likely read only once or twice, in favor of tall bar height codes, which will likely be read multiple times.</p> |

| Field Name | Action/Definition |
|---|--|
| | This is used in tunnel applications where multiple barcodes are read and there is a need to filter out one of the barcodes. If less than x number of scanners read the barcode, then it will be considered a NOREAD for that code. |
| Minimum Readings Difference Between Scanners | Enter the minimum number of scanners that must read a barcode for it to be considered a valid read. |
| Filter Out Single Readings | With the check box selected, if only 1 scanner reads a code it will be considered a NOREAD. |
| Strip Filter | Select the check box to display the Strip Filter Settings options. This is a second level filter that when enabled allows eliminating characters not managed by the host. |

| Strip Filter Settings | |
|--------------------------------------|--|
| Strip All Non Printable Chars | Select the check box to remove all non- printable ASCII characters from the code (000-020 and 127). |
| Char(s) to be Stripped | Click  to activate the Text Entry Tool and enter specific characters to be stripped from the code. Click Submit to save your text to the origin window text field, or click Cancel to return to origin window without transferring text. |
| Strip Filter Collapse | Select the check box to remove the stripped characters from the code and, therefore, reduce the code length (collapsed). It can even be null. |
| Replacement Char | Click  to activate the Text Entry Tool and enter the substitution character to replace all the stripped ones. Click Submit to save your text to the origin window text field, or click Cancel to return to origin window without transferring text. |

- When you have finished making changes, click **Update All** to save all pending changes, click **Reset All** to revert to all previously saved values, and click **Reset Page** to revert to previous saved values on the current page.

Barcode Configuration > Standard Multi Label



When **Standard Multi Label** has been selected from the **Code Combination** drop-down list, the Barcode Configuration window reveals related input fields.



NOTE: In case of Multi Label, the codes will be distinguished EITHER by their symbology, OR by their contents. If two (or more) codes share the same symbology and content, the scanner will perceive them as a unique code.



1. Enter the appropriate information in the form as described below:

| Field Name | Action/Definition |
|-------------------------|--|
| Code Combination | Standard Multi Label has been selected. |
| No Read Message | Select Disable No Read Message , Global No Read Message , or Local No Read(s) Message from the drop-down list. The No Read condition occurs whenever a code cannot be read or decoded. <ul style="list-style-type: none"> • Disable No Read Message: The No Read Message is not transmitted. • Global No Read Message: The No Read String will be sent if the scanner is unable to decode one or more barcodes in the reading phase. • Local No Read(s) Message: This option is useful when one or more codes are not read in the reading phase or when more codes than the expected number set by the configuration parameters are read. |

| Field Name | Action/Definition |
|---|--|
| | If working in Standard Multi Label mode, this option activates the Code Label Local No Read String and the Code Label Local Multiple Read String parameters which allow setting a Local No Read String and a Local Multiple string for each defined code symbology. |
| Use 'Global No Read String' when No Codes Read | Select the check box to allow the Global No Read String to be used if no codes at all are read. This option is not available when Global No Read Message is selected from the No Read Message drop-down list. |
| Global No Read String (max. 128 chars) | Click  to activate the Text Entry Tool and create a string to be displayed when Global No Read Message is selected from the No Read Message drop-down list. Click Submit to save your text to the origin window text field, or click Cancel to return to origin window without transferring text. |
| Multiple Read Message | Select Disable or Enable from the drop-down list. This string will be sent if, during the reading phase, the scanner reads more than the number of the expected barcodes set by the configuration parameters. |
| Multiple Read String (max. 128 chars) | Click  to activate the Text Entry Tool and create a string to be displayed in case of Multiple Read Message . Click Submit to save your text to the origin window text field, or click Cancel to return to origin window without transferring text. This parameter is only available when Multiple Read Message is enabled and the No Read Message selection is different from Local No Read(s) String. It is possible to select either the ASCII or HEX value. If disabled, the scanner transmits the first code read. |
| Send All Multiple Read Labels | For Advanced Data Format only , by enabling this parameter all multiple read labels will be included in the output message. They can be separated by the Multiple Read Separator . Multiple Read Label Separator String (max. 128 chars): <ul style="list-style-type: none"> • The Multiple Read Label Separators (up to 128 bytes) are used to separate multiple read barcodes in the reading phase. • This is meaningful when the Code Combination parameter is set to Multi Label or Logical Combination and the Send All Multiple Read Labels parameter has been enabled. • If selected, they occur within the Code Field and are transmitted after each decoded multiple read barcode. |
| Multi Filters | Select the check box to display the Multi-Filter Settings options. |

| Field Name | Action/Definition |
|---|---|
| Multi-Filter Settings | |
| Contained Filter | <p>Select the check box to reveal the Max Number of Different Characters field.</p> <p>When checked, this filter attempts to eliminate false multiple reads by determining if a short code read is "contained in" (is a sub-string of), another longer code read. This condition implicates that the short code is probably a misread of the same longer code and therefore should be ignored, (should not be considered as a multiple read of a different code).</p> <p>This filter is based upon the following rules:</p> <ul style="list-style-type: none"> • a multiple read condition occurs • all decoded codes of the same type are compared with each other <p>Rule 1: the shorter code is considered contained in the longer code if the character string is found in the same order; the longer code may have a single block of characters in any position (before, after or in between the compared strings)</p> <p>Example: The code 123456 is considered contained in the following codes: <u>00123456</u>, <u>12345600</u>, <u>12378456</u>.</p> <p>The code 123456 is not considered contained in the following codes: 12346507 (string out of order), 12345700 (string not complete), 120378456 or 0012345600 (multiple blocks in the string).</p> <p>Rule 2: the shorter code is not filtered by rule 1. In the longer code, all possible sub-strings of the same length as the shorter code string are compared with the shorter code string. The shorter code is considered contained in the longer code if the number of different characters between the compared codes is less than or equal to the Max Number of Different Characters. The shorter code will be filtered by rule 2.</p> <p>Example:</p> <p>If Max Number of Different Characters = 1:</p> <p>The code 123456 is considered contained in the following codes: 12305600, 00123056, 8812305688 because there is only one different character in the compared string.</p> <p>The code 123456 is not considered contained in 123066789 because there are two different characters in the compared string.</p> <div style="display: flex; align-items: center;">  <p>CAUTION: If the Contained Filter parameter is used when Message Tx Selection (see section 4.5.7) is set to On Decoding, the filter conditions may be satisfied before the reading phase ends resulting in possible successive multiple read errors.</p> </div> |
| Max Number of Different Characters | <p>Enter a value from 0 to 5 in the field provided to define the maximum number of different characters allowed to still consider a code as being included in another one and therefore to be filtered.</p> <p>If the number of different characters between the compared codes exceeds the value of this parameter, the codes are considered as different and will not be filtered (a multiple read of a different code occurs).</p> |

| Field Name | Action/Definition |
|------------------------------------|--|
| | <p>If the number of different characters between the compared codes is less than or equal to the value of this parameter, the short code is considered as a sub-string of the longer code and will be filtered (no multiple read occurs).</p> <p>Examples:</p> <p>If Max Number of Different Characters = 2:</p> <p>The code 123456 read once, is considered the same as the following codes read multiple times: 133056, 123546, 123457 because there are two or less different characters by position in the compared codes.</p> <p>The code 123456 read once, is not considered the same as the following codes read multiple times: 153246, 103057, 654321 because there are at least three different characters by position in the compared codes.</p> |
| Voting Filter | <p>Select the check box to reveal the Max Number of Different Characters field.</p> <p>When selected, this filter attempts to eliminate false multiple reads by comparing the number of different characters by position between two codes of the same type and length. This condition implicates that reading a code of the same type and length having very few different characters is probably a misread of the code itself and therefore the code read the least number of times should be ignored, (should not be considered as a multiple read of a different code).</p> <p>This filter is based upon the following rules:</p> <ul style="list-style-type: none"> • a multiple read condition occurs; • the two codes are of the same type; • the two codes have the same length; • the number of different characters by position is equal to or less than the number defined by the Max Number of Different Characters parameter; • Message Tx Selection (see section 4.5.7) must be set to After Reading Phase Off. |
| Filter Out Low Height Codes | <p>Select the check box to reveal the Minimum Readings Difference Between Scanners field.</p> <p>Background: This option was developed for the airports systems where there are often tall bar height codes and low bar height codes with the same content attached to baggage. Travelers will often remove the large, tall bar height code, while leaving the smaller, low bar height codes attached to the bag. The next time they travel they may have multiple low bar height codes on their baggage plus the new tall bar height and low bar height codes for the new trip.</p> <p>This option instructs the system to ignore low bar height codes, which are likely read only once or twice, in favor of tall bar height codes, which will likely be read multiple times.</p> <p>This is used in tunnel applications where multiple barcodes are read and there is a need to filter out one of the barcodes. If less than <i>x</i> number of scanners read the barcode, then it will be considered a NOREAD for that code.</p> |

| Field Name | Action/Definition |
|---|---|
| Minimum Readings Difference Between Scanners | Enter the minimum number of scanners that must read a barcode for it to be considered a valid read. |
| Filter Out Single Readings | With the check box selected, if only 1 scanner reads a code it will be considered a NOREAD. |
| Strip Filter | Select the check box to display the Strip Filter Settings options. This is a second level filter that when enabled allows eliminating characters not managed by the host. |
| Strip Filter Settings | |
| Strip All Non Printable Chars | Select the check box to remove all non- printable ASCII characters from the code (000-020 and 127). |
| Char(s) to be Stripped | Click  to activate the Text Entry Tool and enter specific characters to be stripped from the code. Click Submit to save your text to the origin window text field, or click Cancel to return to origin window without transferring text. |
| Strip Filter Collapse | Select the check box to remove the stripped characters from the code and, therefore, reduce the code length (collapsed). It can even be null. |
| Replacement Char | Click  to activate the Text Entry Tool and enter the substitution character to replace all the stripped ones. Click Submit to save your text to the origin window text field, or click Cancel to return to origin window without transferring text. |

- When you have finished making changes, click **Update All** to save all pending changes, click **Reset All** to revert to all previously saved values, and click **Reset Page** to revert to previous saved values on the current page.

Barcode Configuration > Logical Combination

When **Logical Combination** has been selected from the **Code Combination** drop-down list, the Barcode Configuration window reveals related input fields.

Barcode Configuration

Code Combination Logical Combination ▼

Logical Combination Rule 1&2&3&4

No Read Message Local No Read(s) Mess: ▼

Use 'Global No Read String' when No Codes Read

Global No Read String ????????????????????

Multiple Read Message Enable ▼

WebSentinel - Partial Read Is Treated As Good Read ▼

Group No Read Messages

Group 1 No Read String ????

Group 2 No Read String ????

Group 3 No Read String ????

Group 4 No Read String ????

Group Multiple Read Messages

Group 1 Multiple Read String !!!!

Group 2 Multiple Read String !!!!

Group 3 Multiple Read String !!!!

Group 4 Multiple Read String !!!!

Multi Filters

Multi-Filter Settings

Contained Filter

Maximum Number of Different Characters

Voting Filter

Maximum Number of Different Characters

Filter Out Low Height Codes

Minimum Readings Difference Between Scanners

Filter Out Single Readings

Strip Filter

Strip Filter Settings

Strip All Non Printable Chars

Char(s) to be Stripped

Strip Filter Collapse

Priority Filter Enable

Priority Filter Group List

Priority Filter Type Advanced ▼

Priority Filter Advanced String

1. Enter the appropriate information in the form as described below:

| Field Name | Action/Definition |
|--------------------------|--|
| Code Combination | Standard Multi Label has been selected. |
| Logical Combination Rule | Click  to activate the code group selection dialog box. |

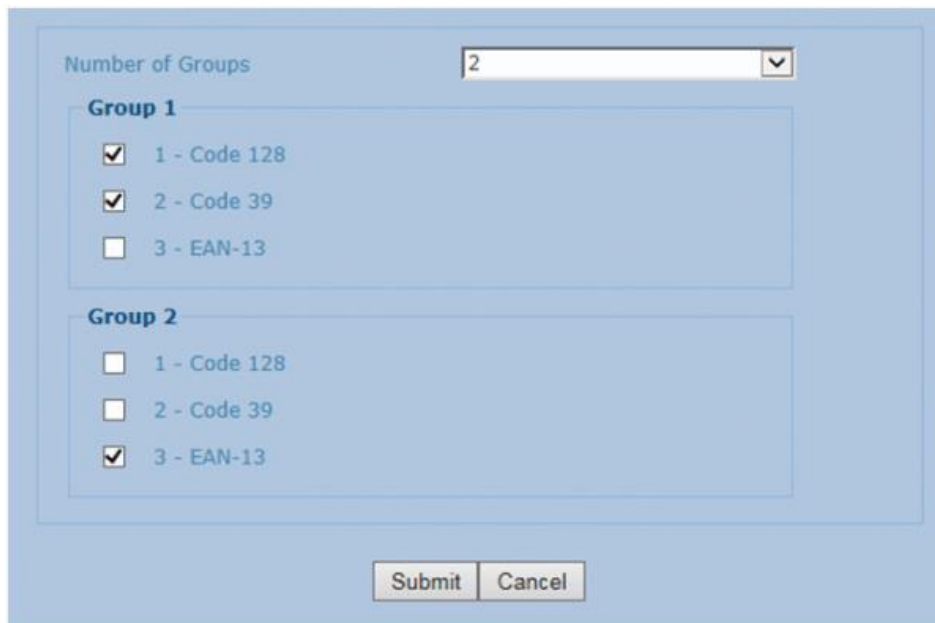

Select the number of groups you wish to use from the Number of Groups drop-down list. Then select the check box next to the Group/Code you wish to define. Click **Submit** to save your text to the origin window text field, or click **Cancel** to return to origin window without transferring text.

Groups and their order define the output message format, while each group identifies an expected code.

When editing the logical combination rule, proceed as follows:

1. Define the Barcode Settings indicating the type of expected code labels. It is possible to define up to 10 different code types;
2. Define how many code types (groups) are expected by editing the combination rule through the following logical operators. Each group may include one or more selected code types.

& = AND operator which separates a group from the previous/following one;

^ = XOR operator to be used to combine different code labels within the same group. It allows reading one of the defined code labels.

The maximum number of groups to be defined for each rule string is 15.

If Local No Read Message is selected from the No Read Message drop-down list, the Group No Read Messages parameter group is displayed requiring the definition of a Local No Read String for each group.

| Field Name | Action/Definition |
|------------|-------------------|
|------------|-------------------|

Examples: Logical Combination Rule

For all the following examples the **No Read Message** parameter is set to **Global No Read Message**.

Example 1

Code label setting#1 = Code 128
 Logical Combination Rule = 1&1
 Defines 2 groups, each of them expecting a Code 128 label.

| Decoded Code Symbology | | Output Message |
|------------------------|-----------------|---|
| First Label #1 | Second Label #1 | |
| --- | --- | <Header><Global No Read Message><Terminator> |
| X | --- | <Header><Global No Read Message><Terminator> |
| --- | X | <Header><Global No Read Message><Terminator> |
| X | X | <Header><Code 128 data><Data Packet Separator><Code 128 data><Terminator> |



NOTE: If **Multiple Read Message** is enabled and a third label belonging to the Code 128 symbology is decoded, the **Multiple Read** string is transmitted instead. If the **Multiple Read Message** is disabled, the third code label is ignored and only the first two codes are transmitted.

For advanced formatting, if the **Send All Multiple Read Labels** parameter is enabled, then all three labels are sent in the output message; the multiple read label is separated by its own **Multiple Read Label Separator String** which should be different from the **Data Packet Separator (DPS)**.

Example 2

Code label setting#1 = Code 39
 Code label setting#2 = Code 128
 Logical Combination Rule = 1^2
 Defines a single group expecting a Code 128 label OR a Code 39 label.

| Decoded Code Symbology | | Output Message |
|------------------------|----------|--|
| Label #1 | Label #2 | |
| --- | --- | <Header><Global No Read Message><Terminator> |
| X | --- | <Header><Code 39 data><Terminator> |
| --- | X | <Header><Code 128 data><Terminator> |
| X | X | <Header><First decoded code/Multiple Read Message string ><Terminator> |

| Field Name | Action/Definition |
|------------|-------------------|
|------------|-------------------|

Example 3

Code label setting#1 = EAN 8

Code label setting#2 = UPC-A

Logical Combination Rule = 1&1&1^2

Defines three different groups. The first two groups expect an EAN 8 label while the third one expects an EAN 8 label OR an UPC-A label.

| Decoded Code Symbology | | | | Output Message |
|------------------------|-----------------|----------------|----------|---|
| First Label #1 | Second Label #1 | Third Label #1 | Label #2 | |
| --- | --- | --- | --- | <Header><Global No Read Message><Terminator> |
| X | --- | --- | --- | <Header><Global No Read Message><Terminator> |
| --- | X | --- | --- | <Header><Global No Read Message><Terminator> |
| --- | --- | X | --- | <Header><Global No Read Message><Terminator> |
| --- | --- | --- | X | <Header><Global No Read Message><Terminator> |
| X | X | X | --- | <Header><EAN 8 data><DPS><EAN 8 data><DPS><EAN 8 data><Terminator> |
| X | X | --- | X | <Header><EAN 8 data><DPS><EAN 8 data><DPS><UPC-A data><Terminator> |
| X | X | X | X | <Header><EAN 8 data><DPS><EAN 8 data><DPS><First decoded code/Multiple Read Message string><Terminator> |

| Field Name | Action/Definition |
|------------|-------------------|
|------------|-------------------|



Example 4

Code label setting#1 = Code 93
 Code label setting#2 = Interleaved 2/5
 Code label setting#3= EAN-8
 Code label setting#4= UPC-A

Logical Combination Rule = 1^2&3^4

Defines 2 groups, each of them expecting one of the defined code types. The first group may expect a Code 93 label or an Interleaved 2/5 label. The second group may expect an EAN-8 label or an UPC-A label.

| Decoded Code Symbology | | | | Output Message |
|------------------------|----------|----------|----------|---|
| Label #1 | Label #2 | Label #3 | Label #4 | |
| --- | --- | --- | --- | <Header><Global No Read Message><Terminator> |
| X | --- | --- | --- | <Header><Global No Read Message><Terminator> |
| --- | X | --- | --- | <Header><Global No Read Message><Terminator> |
| --- | --- | X | --- | <Header><Global No Read Message><Terminator> |
| --- | --- | --- | X | <Header><Global No Read Message><Terminator> |
| X | X | --- | --- | <Header><Global No Read Message><Terminator> |
| X | --- | X | X | <Header><Code93><DPS>< First decoded code/Multiple Read Message string><Terminator> |
| X | X | X | --- | <Header><First decoded code/Multiple Read Message string><DPS><EAN 8 data><Terminator> |
| --- | X | X | X | <Header>< Interleaved 2/5 data><DPS>< First decoded code/Multiple Read Message string ><Terminator> |
| X | --- | X | --- | <Header><Code 93 data><DPS><EAN 8 data><Terminator> |
| X | --- | --- | X | <Header><Code 93 data><DPS><UPC-A data><Terminator> |
| --- | X | X | --- | <Header><Interleaved 2/5 data><DPS><EAN 8 data><Terminator> |
| --- | X | --- | X | <Header><Interleaved 2/5 data><DPS><UPC-A data><Terminator> |
| X | X | X | X | <Header><First decoded code/Multiple Read Message string><DPS>< First decoded code/Multiple Read Message string ><Terminator> |

| Field Name | Action/Definition |
|---|--|
| No Read Message | <p>Select Disable No Read Message, Global No Read Message, or Local No Read(s) Message from the drop-down list. The No Read condition occurs whenever a code cannot be read or decoded.</p> <ul style="list-style-type: none"> • Disable No Read Message: The No Read Message is not transmitted. • Global No Read Message: The No Read String will be sent if the scanner is unable to decode one or more barcodes in the reading phase. • Local No Read(s) Message: This option is useful when one or more codes are not read in the reading phase or when more codes than the expected number set by the configuration parameters are read. <p>If working in Logical Combination mode, this option reveals Group No Read Messages fields, which allows entering group no read strings for each defined code symbology.</p> |
| Use 'Global No Read String' when No Codes Read | Select the check box to allow the Global No Read String to be used if no codes at all are read. This option is not available when Global No Read Message is selected from the No Read Message drop-down list. |
| Global No Read String (max. 128 chars) | Click  to activate the Text Entry Tool and create a string to be displayed when Global No Read Message is selected from the No Read Message drop-down list. Click Submit to save your text to the origin window text field, or click Cancel to return to origin window without transferring text. |
| Multiple Read Message | <p>Select Disable or Enable from the drop-down list. This string will be sent if, during the reading phase, the scanner reads more than the number of the expected barcodes set by the configuration parameters.</p> <p>If Disable No Read Message or Global No Read Message is selected from the No Read Message drop-down list, this string will be sent if, during the reading phase, the scanner reads more than the number of the expected barcodes set by the configuration parameters.</p> <p>If Local No Read(s) Message is selected from the No Read Message drop-down list, the Group Multiple Read Messages fields appears, allowing the user to enter strings for each Group.</p> |
| Multiple Read String (max. 128 chars) | <p>Click  to activate the Text Entry Tool and create a string to be displayed in case of Multiple Read Message. Click Submit to save your text to the origin window text field, or click Cancel to return to origin window without transferring text.</p> <p>This parameter is only available when Multiple Read Message is enabled and the No Read Message selection is different from Local No Read(s) String. It is possible to select either the ASCII or HEX value. If disabled, the scanner transmits the first code read.</p> |
| Send All Multiple Read Labels | <p>For Advanced Data Format only, by enabling this parameter all multiple read labels will be included in the output message. They can be separated by the Multiple Read Separator.</p> <p>Multiple Read Label Separator String (max. 128 chars):</p> <p>The Multiple Read Label Separators (up to 128 bytes) are used to separate multiple read barcodes in the reading phase.</p> |

| Field Name | Action/Definition |
|---|--|
| | This is meaningful when the Code Combination parameter is set to Multi Label or Logical Combination and the Send All Multiple Read Labels parameter has been enabled. If selected, they occur within the Code Field and are transmitted after each decoded multiple read barcode. |
| WebSentinel - Partial Read Is Treated As | Select No Read , Good Read , or Partial Read from the drop-down list. This determines how WebSentinel will treat the partial read. |
| Multi Filters | Select the check box to display the Multi-Filter Settings options. |

Multi-Filter Settings

Contained Filter Select the check box to reveal the **Max Number of Different Characters** field.

When checked, this filter attempts to eliminate false multiple reads by determining if a short code read is "contained in" (is a sub-string of), another longer code read. This condition implicates that the short code is probably a misread of the same longer code and therefore should be ignored, (should not be considered as a multiple read of a different code).

This filter is based upon the following rules:

- a multiple read condition occurs
- all decoded codes of the same type are compared with each other

Rule 1: the shorter code is considered contained in the longer code if the character string is found in the same order; the longer code may have a single block of characters in any position (before, after or in between the compared strings)

Example: The code **123456** is considered contained in the following codes: 00**123456**, **123456**00, **12378456**.

The code **123456** is not considered contained in the following codes: 1234**65**07 (string out of order), 12345**700** (string not complete), **120378456** or **0012345600** (multiple blocks in the string).

Rule 2: the shorter code is not filtered by rule 1. In the longer code, all possible sub-strings of the same length as the shorter code string are compared with the shorter code string. The shorter code is considered contained in the longer code if the number of different characters between the compared codes is less than or equal to the Max Number of Different Characters. The shorter code will be filtered by rule 2.

Example:

If Max Number of Different Characters = 1:

The code **123456** is considered contained in the following codes: **123056**00, 00**123056**, 88**123056**88 because there is only one different character in the compared string.

The code **123456** is not considered contained in **123066**789 because there are two different characters in the compared string.

| Field Name | Action/Definition |
|------------|-------------------|
|------------|-------------------|



CAUTION: If the Contained Filter parameter is used when **Message Tx Selection** (see section 4.5.7) is set to **On Decoding**, the filter conditions may be satisfied before the reading phase ends resulting in possible successive multiple read errors.

| | |
|---|--|
| Max Number of Different Characters | Enter a value from 0 to 5 in the field provided to define the maximum number of different characters allowed to still consider a code as being included in another one and therefore to be filtered. |
|---|--|

If the number of different characters between the compared codes exceeds the value of this parameter, the codes are considered as different and will not be filtered (a multiple read of a different code occurs).

If the number of different characters between the compared codes is less than or equal to the value of this parameter, the short code is considered as a substring of the longer code and will be filtered (no multiple read occurs).

Examples:

If Max Number of Different Characters = 2:

The code **123456** read once, is considered the same as the following codes read multiple times: **133056**, **123546**, **123457** because there are two or less different characters by position in the compared codes.



The code **123456** read once, is not considered the same as the following codes read multiple times: **153246**, **103057**, **654321** because there are at least three different characters by position in the compared codes.

| | |
|----------------------|---|
| Voting Filter | Select the check box to reveal the Max Number of Different Characters field. |
|----------------------|---|

When checked, this filter attempts to eliminate false multiple reads by comparing the number of different characters by position between two codes of the same type and length. This condition implicates that reading a code of the same type and length having very few different characters is probably a misread of the code itself and therefore the code read the least number of times should be ignored, (should not be considered as a multiple read of a different code).

This filter is based upon the following rules:

- a multiple read condition occurs;
- the two codes are of the same type;
- the two codes have the same length;
- the number of different characters by position is equal to or less than the number defined by the **Max Number of Different Characters** parameter;
- **Message Tx Selection** (see section 4.5.7) must be set to **After Reading Phase Off**.

| Field Name | Action/Definition |
|---|--|
| Filter Out Low Height Codes | <p>Select the check box to reveal the Minimum Readings Difference Between Scanners field.</p> <p>Background: This option was developed for the airports systems where there are often tall bar height codes and low bar height codes with the same content attached to baggage. Travelers will often remove the large, tall bar height code, while leaving the smaller, low bar height codes attached to the bag. The next time they travel they may have multiple low bar height codes on their baggage plus the new tall bar height and low bar height codes for the new trip.</p> <p>This option instructs the system to ignore low bar height codes, which are likely read only once or twice, in favor of tall bar height codes, which will likely be read multiple times.</p> <p>This is used in tunnel applications where multiple barcodes are read and there is a need to filter out one of the barcodes. If less than <i>x</i> number of scanners read the barcode, then it will be considered a NOREAD for that code.</p> |
| Minimum Readings Difference Between Scanners | Enter the minimum number of scanners that must read a barcode for it to be considered a valid read. |
| Filter Out Single Readings | With the check box selected, if only 1 scanner reads a code it will be considered a NOREAD. |
| Strip Filter | Select the check box to display the Strip Filter Settings options. This is a second level filter that when enabled allows eliminating characters not managed by the host. |
| Strip Filter Settings | <p>Strip All Non Printable Chars Select the check box to remove all non- printable ASCII characters from the code (000-020 and 127).</p> <hr/> <p>Char(s) to be Stripped Click  to activate the Text Entry Tool and enter specific characters to be stripped from the code. Click Submit to save your text to the origin window text field, or click Cancel to return to origin window without transferring text.</p> <hr/> <p>Strip Filter Collapse Select the check box to remove the stripped characters from the code and, therefore, reduce the code length (collapsed). It can even be null.</p> <hr/> <p>Replacement Char Click  to activate the Text Entry Tool and enter the substitution character to replace all the stripped ones. Click Submit to save your text to the origin window text field, or click Cancel to return to origin window without transferring text.</p> |

| Field Name | Action/Definition |
|-----------------------------------|--|
| Priority Filter Enable | <p>Select the check box to display the Priority Filter options. This function allows the user to prioritize barcodes.</p> <p>Example:</p> <p>If there is a message with a field that should contain one of multiple code types (for example, Code128, Code39 and I2of5). In this field, the user wants:</p> <ul style="list-style-type: none"> • If Code 128 is read, it goes in the field (any code39 and I2of5 are ignored) • If Code 128 is not read – if Code39 is read, it goes in the field (and I2of5 is ignored) • If Code 128 and Code30 are not read – if i2of5 is read, it goes in the field. |
| Priority Filter Group List | <p>Enter the Group List in the field provided. This field defines the specific Logical Combination groups to which the Priority Filter will apply. The groups are numbered according to the order in which they are listed (from left to right) in the Logical Combination Rule parameter.</p> <p>Format: Group Number(s) separated by the comma character</p> <p>Example:</p> <p>1,3 means the Priority Filter is applied to Logical Groups 1 and 3. Logical Group 2 will not have the Priority Filter applied, however it will follow the normal rules of code analysis, and if selected, the Strip Filter parameters will apply.</p> |
| Priority Filter Type | <p>Select Normal or Advanced from the drop-down list.</p> <p>Description:</p> <ul style="list-style-type: none"> • Normal: Uses the Logical Combination Rule string to define the priority • Advanced: Uses the Priority Filter Advanced String to define the priority. Advanced type allows the priority filter to essentially take "priority" over the Logical Combination Rule string. <p><u>NORMAL</u></p> <p>When the Priority Filter Type is set to Normal, the operators used in the Logical Combination Rule string have the following meaning:</p> <p>& = AND operator which separates a group from the previous/following one;</p> <p>^ = The priority is given to the code label indicated to the left of the operator. If this code is read, the group is in Good Read independent from any other code in the same group.</p> |

| Field Name | Action/Definition |
|------------|-------------------|
|------------|-------------------|

Example:

Logical Combination Rule = 1^2&5^3^4&6^7 (3 groups)

Results Without Priority Filter:

Group 1 - read either code 1 or 2 = Good Read;
read both code 1 and 2 = Multiple Read

Group 2 - read either code 5 or 3 or 4 = Good Read;
read any combination = Multiple Read

Group 3 - read either code 6 or 7 = Good Read;
read both code 6 and 7 = Multiple Read

Results With Priority Filter:

Filter Enabled on Groups = 1,2

Group 1 - read code 1 = Good Read independent
from reading code 2

Group 2 - read code 5 = Good Read independent
from reading code 3 or 4; read code 3 = Good
Read independent from reading code 4

Group 3 - read either code 6 or 7 = Good Read;
read both code 6 and 7 = Multiple Read

ADVANCED

When the **Priority Filter Type** is set to **Advanced**, the **Priority Filter Advanced String** applies to the Logical Combination Groups. This string must correspond to the order of the groups defined in the Logical Combination Rule string.

The following operators can be used:

& = Code group separator. This operator separates a group from the previous/following one;

^ = The priority is given to the code label indicated to the left of this operator. If this code is read, the group is in Good Read independent from any other code in the same group.

| = Equal priority operator (vertical line). Codes separated by this operator have the same priority and if both codes are read a Multiple Read will result.

The only difference from the implicit pattern string of the Normal (default) case when the Logical Combination Rule string is used, is the Equal Priority operator.

| Field Name | Action/Definition |
|--|--|
| Example: | Logical Combination Rule = 1^2&5^3^4&8^6^7 (3 groups) |
| Results Without Priority Filter: | Group 1 - read either code 1 or 2 = Good Read; read both code 1 and 2 = Multiple Read |
| Group 2 - read either code 5 or 3 or 4 = Good Read; read any combination = Multiple Read | |
| Group 3 - read either code 8 or 6 or 7 = Good Read; read any combination = Multiple Read | |
| Results With Priority Filter: | Filter Enabled on Groups = 1,3 |
| | Filter Type =Custom |
| | Custom Filter Pattern String = 1^2&8^6 7 (2 groups) |
| | Group 1 - read code 1 = Good Read independent from reading code 2 |
| | Group 2 - read either code 5 or 3 or 4 = Good Read; read any combination = Multiple Read |
| | Group 3 - read code 8 = Good Read independent from reading code 6 or 7; no read on code 8 and read either code 6 or 7 = Good Read; no read on code 8 and read both code 6 and 7 = Multiple Read |
| Priority Filter Advanced String | Enter the character string (see above). |

- When you have finished making changes, click **Update All** to save all pending changes, click **Reset All** to revert to all previously saved values, and click **Reset Page** to revert to previous saved values on the current page.

Barcode Configuration > Code Collection

When **Code Collection** has been selected from the **Code Combination** drop-down list, the Barcode Configuration window reveals related input fields.

The screenshot shows the 'Barcode Configuration' window. At the top, 'Code Combination' is set to 'Code Collection' and 'No Read Message' is set to 'Global No Read Mess:'. Below this is a 'No Read String (max. 128 chars)' field with a question mark. The 'Code Collection Settings' section includes 'Associate Same Codes When Read By Different Scanners' (checkbox), 'Code Different When Scan Gap Is Greater Than' (input: 0), and 'Code Different When Code Position Gap Is Greater Than' (input: 0). The 'Multi Filters' section has a checked checkbox. The 'Multi-Filter Settings' section includes 'Contained Filter' (checkbox), 'Maximum Number of Different Characters' (input: 0), 'Voting Filter' (checkbox), 'Maximum Number of Different Characters' (input: 2), 'Filter Out Low Height Codes' (checkbox), 'Minimum Readings Difference Between Scanners' (input: 2), 'Filter Out Single Readings' (checkbox), and 'Strip Filter' (checkbox). The 'Strip Filter Settings' section includes 'Strip All Non Printable Chars' (checkbox), 'Char(s) to be Stripped' (input), 'Strip Filter Collapse' (checkbox), and 'Replacement Char' (input: #). At the bottom are 'Update All', 'Reset All', and 'Reset Page' buttons.

1. Enter the appropriate information in the form as described below:

| Field Name | Action/Definition |
|-------------------------|--|
| Code Combination | Code Collection has been selected. |
| No Read Message | Select Disable No Read Message , Global No Read Message , or Local No Read(s) Message from the drop-down list. The No Read condition occurs whenever a code cannot be read or decoded. <ul style="list-style-type: none"> • Disable No Read Message: The No Read Message is not transmitted. • Global No Read Message: The No Read String will be sent if the scanner is unable to decode one or more barcodes in the reading phase. • Local No Read(s) Message: This option is useful when one or more codes are not read in the reading phase or when more codes than the expected number set by the configuration parameters are read. <p>If working in Standard Multi Label mode, this option activates the Code Label Local No Read String and the Code Label Local Multiple Read String parameters which allow setting a Local No Read String and a Local Multiple string for each defined code symbology.</p> |

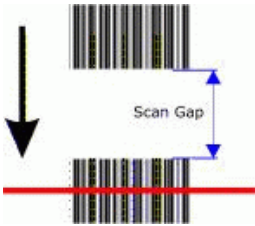
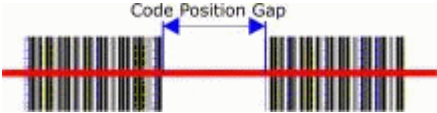
| Field Name | Action/Definition |
|--|--|
| Use 'Global No Read String' when No Codes Read | Select the check box to allow the Global No Read String to be used if no codes at all are read. This option is not available when Global No Read Message is selected from the No Read Message drop-down list. |
| Global No Read String (max. 128 chars) | Click  to activate the Text Entry Tool and create a string to be displayed when Global No Read Message is selected from the No Read Message drop-down list. Click Submit to save your text to the origin window text field, or click Cancel to return to origin window without transferring text. |
| Multi Filters | Select the check box to display the Multi-Filter Settings options. |
| Code Collection Settings | |
| Associate Same Codes When Read By Different Scanners | <p>Select the check box to enable this function.</p> <p>This parameter is available only when the Code Combination parameter is set to Code Collection and the scanner role is Master. If enabled, it allows transmitting all codes belonging to the same programmed Slot (same symbology and content) but read by different scanners (including the Master) in a single instance.</p> <p>Scanner Role:</p> <ul style="list-style-type: none"> • Master SYNCHRONIZED: The scanner is connected as a Master in a master/slave synchronized configuration. • Slave SYNCHRONIZED: The scanner is connected as a Slave in a master/slave synchronized configuration. (See note below.) • Other: This selection is for a stand-alone scanner. |
| Code Different When Scan Gap Is Greater Than | <p>This parameter is available only when the Code Combination parameter is set to Code Collection. If the number of scans performed between two consecutive codes read (by the Master or Stand Alone scanner) is greater than the defined number, the codes will be considered as different.</p> <p>The parameter set to 0 means the filter is disabled: when there is no scan gap all the consecutive codes read will be considered as only one code.</p>  |
| Code Different When Code Position Gap Is Greater Than | <p>This parameter is available only when the Code Combination parameter is set to Code Collection. If the position gap between two consecutive codes read (by the Master or Stand Alone scanner) on the same scan line is greater than the defined gap number, the codes will be considered as different.</p> <p>The parameter set to 0 means the filter is disabled: when there is no code position gap all the consecutive codes read will be considered as only one code.</p>  |

| Field Name | Action/Definition |
|------------|-------------------|
|------------|-------------------|

Multi-Filter Settings

Contained Filter Select the check box to reveal the **Max Number of Different Characters** field.

When checked, this filter attempts to eliminate false multiple reads by determining if a short code read is "contained in" (is a sub-string of), another longer code read. This condition implicates that the short code is probably a misread of the same longer code and therefore should be ignored, (should not be considered as a multiple read of a different code).

This filter is based upon the following rules:

- a multiple read condition occurs
- all decoded codes of the same type are compared with each other

Rule 1: the shorter code is considered contained in the longer code if the character string is found in the same order; the longer code may have a single block of characters in any position (before, after or in between the compared strings)

Example: The code **123456** is considered contained in the following codes: **00123456**, **12345600**, **12378456**.

The code **123456** is not considered contained in the following codes: **12346507** (string out of order), **12345700** (string not complete), **120378456** or **0012345600** (multiple blocks in the string).

Rule 2: the shorter code is not filtered by rule 1. In the longer code, all possible sub-strings of the same length as the shorter code string are compared with the shorter code string. The shorter code is considered contained in the longer code if the number of different characters between the compared codes is less than or equal to the Max Number of Different Characters. The shorter code will be filtered by rule 2.

Example:

If Max Number of Different Characters = 1:

The code **123456** is considered contained in the following codes: **12305600**, **00123056**, **8812305688** because there is only one different character in the compared string.

The code **123456** is not considered contained in **123066789** because there are two different characters in the compared string.



CAUTION: If the Contained Filter parameter is used when **Message Tx Selection** (see section 4.5.7) is set to **On Decoding**, the filter conditions may be satisfied before the reading phase ends resulting in possible successive multiple read errors.



Max Number of Different Characters Enter a value from 0 to 5 in the field provided to define the maximum number of different characters allowed to still consider a code as being included in another one and therefore to be filtered.

If the number of different characters between the compared codes exceeds the value of this parameter, the codes are considered as different and will not be filtered (a multiple read of a different code occurs).

| Field Name | Action/Definition |
|---|---|
| | <p>If the number of different characters between the compared codes is less than or equal to the value of this parameter, the short code is considered as a substring of the longer code and will be filtered (no multiple read occurs).</p> <p>Examples:</p> <p>If Max Number of Different Characters = 2: The code 123456 read once, is considered the same as the following codes read multiple times: 133056, 123546, 123457 because there are two or less different characters by position in the compared codes.</p> <p>The code 123456 read once, is not considered the same as the following codes read multiple times: 153246, 103057, 654321 because there are at least three different characters by position in the compared codes.</p> |
| Voting Filter | <p>Select the check box to reveal the Max Number of Different Characters field. When checked, this filter attempts to eliminate false multiple reads by comparing the number of different characters by position between two codes of the same type and length. This condition implicates that reading a code of the same type and length having very few different characters is probably a misread of the code itself and therefore the code read the least number of times should be ignored, (should not be considered as a multiple read of a different code).</p> <p>This filter is based upon the following rules:</p> <ul style="list-style-type: none"> • a multiple read condition occurs; • the two codes are of the same type; • the two codes have the same length; • the number of different characters by position is equal to or less than the number defined by the Max Number of Different Characters parameter; • Message Tx Selection (see section 4.5.7) must be set to After Reading Phase Off. |
| Filter Out Low Height Codes | <p>Select the check box to reveal the Minimum Readings Difference Between Scanners field.</p> <p>Background: This option was developed for the airports systems where there are often tall bar height codes and low bar height codes with the same content attached to baggage. Travelers will often remove the large, tall bar height code, while leaving the smaller, low bar height codes attached to the bag. The next time they travel they may have multiple low bar height codes on their baggage plus the new tall bar height and low bar height codes for the new trip.</p> <p>This option instructs the system to ignore low bar height codes, which are likely read only once or twice, in favor of tall bar height codes, which will likely be read multiple times.</p> <p>This is used in tunnel applications where multiple barcodes are read and there is a need to filter out one of the barcodes. If less than <i>x</i> number of scanners read the barcode, then it will be considered a NOREAD for that code.</p> |
| Minimum Readings Difference Between Scanners | <p>Enter the minimum number of scanners that must read a barcode for it to be considered a valid read.</p> |

| Field Name | Action/Definition |
|----------------------------|--|
| Filter Out Readings | Single With the check box selected, if only 1 scanner reads a code it will be considered a NOREAD. |
| Strip Filter | Select the check box to display the Strip Filter Settings options. This is a second level filter that when enabled allows eliminating characters not managed by the host. |

Strip Filter Settings

| | |
|--------------------------------------|---|
| Strip All Non Printable Chars | Select the check box to remove all non- printable ASCII characters from the code (000-020 and 127). |
| Char(s) to be Stripped | Click  to activate the Text Entry Tool and enter specific characters to be stripped from the code. Click Submit to save your text to the origin window text field, or click Cancel to return to origin window without transferring text. |
| Strip Filter Collapse | Select the check box to remove the stripped characters from the code and, therefore, reduce the code length (collapsed). It can even be null. |
| Replacement Char | Click  to activate the Text Entry Tool and enter the substitution character to replace all the stripped ones. Click Submit to save your text to the origin window text field, or click Cancel to return to origin window without transferring text. |

- When you have finished making changes, click **Update All** to save all pending changes, click **Reset All** to revert to all previously saved values, and click **Reset Page** to revert to previous saved values on the current page.

4.5.4 Modify Settings | Global Settings | Serial Ports

Use the Serial Ports menu tree selections during initial setup to configure any serial ports used by your barcode scanning system. If necessary, you can later make modifications to the global system settings using the same menu selections, including:



Modify Settings | Global Settings | Serial Ports | Main Port

Use **Main Port** window to configure communication between the scanner and the Host, or in a multi-sided layout, between several scanners and a Host.

To edit the **Main Port** settings:

1. In the tree menu under **Modify Settings**, navigate to **Global Settings | Serial Ports | Main Port**. The Main Port window opens.

Main Serial Port

Data Tx

Heartbeat Enable Unconditione...

Heartbeat Settings

Heartbeat Timeout sec

Heartbeat Message (max. 32 chars)

Heartbeat Terminator (max. 32 chars)

Line Settings

Main Port Electrical Interface RS232

Handshake None

Baud Rate 115200

Parity None

Data Bits 8



Stop Bits 1

Update All Reset All Reset Page

2. Enter the appropriate information in the form as described below:

| Field Name | Action/Definition |
|------------------|--|
| Data Tx | Select the check box to enabled Data Tx . If selected, the Main Serial Port channel is used by the scanner to transmit data and/or messages. |
| Heartbeat | <p>Select Disable, Enable Unconditioned, or Enable Conditioned from the drop-down list. This parameter is available when the Data TX parameter is checked. It enables/disables the transmission of the Heartbeat message signaling that the device is still active.</p> <ul style="list-style-type: none"> • Disable: The Heartbeat message is not transmitted • Enable Unconditioned: The Heartbeat message is always transmitted, even if communication is still active • Enable Conditioned: The Heartbeat message is transmitted only when there is no communication |

Heartbeat Settings

| | |
|---|---|
| Heartbeat Timeout | Enter a time value in seconds to define the amount of time between two message transmissions. If the input timeout expires and no transmission has occurred, the Heartbeat message will be transmitted. |
| Heartbeat Message (max. 32 chars) | <p>Click  to activate the Text Entry Tool and create heartbeat header text to signal the beginning of the heartbeat message. Characters from NUL (00H) to ~ (7EH) can be used. Click Submit to save your text to the origin window text field, or click Cancel to return to origin window without transferring text.</p> <p>The Heartbeat Message (header) string must be different from the Heartbeat Terminator string.</p> |
| Heartbeat Terminator (max. 32 chars) | <p>Click  to activate the Text Entry Tool and create Heartbeat Terminator text to signal the end of the heartbeat message. Characters from NUL (00H) to ~ (7EH) can be used. Click Submit to save your text to the origin window text field, or click Cancel to return to origin window without transferring text.</p> <p>The Heartbeat Terminator string must be different from the Heartbeat Message (header) string.</p> |

Line Settings

| | |
|---------------------------------------|---|
| Main Port Electrical Interface | Select RS232 or RS422 full duplex from the drop-down list. The Main serial interface is compatible with these available electrical standards. |
| Handshake | Select None , Hardware (RTS/CTS) , or Software (Xon/Xoff) from the drop-down list. Handshake is a communication control used to protect against data loss, it can be achieved via hardware (RTS\CTS protocol) or software (Xon\Xoff protocol). |
| Baud Rate | Select a value from 1200 to 115200 from the drop-down list. Baud Rate is the transmission speed in a communication line. |
| Parity | Select None , Odd , or Even from the drop-down list. Parity is a parameter indicating the presence of a control bit in the communication protocol frame. |

| Field Name | Action/Definition |
|------------|---|
| Data Bits | Select 7 or 8 from the drop-down list. Data Bits is a parameter indicating the number of bits composing the data packet of the communication protocol frame. |
| Stop Bits | Select 1 or 2 from the drop-down list. Stop Bits is a parameter indicating the number of stop bits in the data packet of the communication protocol frame. |

- When you have finished making changes, click **Update All** to save all pending changes, click **Reset All** to revert to all previously saved values, and click **Reset Page** to revert to previous saved values on the current page.

Modify Settings | Global Settings | Serial Ports | Aux Port

Use the **Aux Port** window to configure communication through the Auxiliary Serial Port. For this communication mode, RS232 interface is automatically selected.

To edit the Aux Port settings:

- In the tree menu under **Modify Settings**, navigate to **Global Settings | Serial Ports | Aux Port**. The Aux Port window opens.

Aux Serial Port

Search for CBX BM100 at Device Startup

Data Tx

Heartbeat Enable Unconditionec ▾

Heartbeat Settings

Heartbeat Timeout 60 sec

Heartbeat Message (max. 32 chars) <STX> ✎

Heartbeat Terminator (max. 32 chars) <ETX> ✎

Line Settings

Baud Rate 115200 ▾

Parity None ▾

Data Bits 8 ▾



Stop Bits 1 ▾

Update All Reset All Reset Page

2. Enter the appropriate information in the form as described below:

| Field Name | Action/Definition |
|---|--|
| Search for CBX BM100 at Device Startup | Select the check box to automatically search for a BM100 storage module when the scanner is powered on. |
| Data Tx | Select the check box to enabled Data Tx . If selected, the Aux Serial Port channel is used by the scanner to transmit data and/or messages. |
| Heartbeat | <p>Select Disable, Enable Unconditioned, or Enable Conditioned from the drop-down list. This parameter is available when the Data TX parameter is checked. It enables/disables the transmission of the Heartbeat message signaling that the device is still active.</p> <ul style="list-style-type: none"> • Disable: The Heartbeat message is not transmitted • Enable Unconditioned: The Heartbeat message is always transmitted, even if communication is still active • Enable Conditioned: The Heartbeat message is transmitted only when there is no communication |

Heartbeat Settings

| | |
|---|--|
| Heartbeat Timeout | Enter a time value in seconds to define the amount of time between two message transmissions. If the input timeout expires and no transmission has occurred, the Heartbeat message will be transmitted. |
| Heartbeat Message (max. 32 chars) | <p>Click  to activate the Text Entry Tool and create heartbeat header text to signal the beginning of the heartbeat message. Characters from NUL (00H) to ~ (7EH) can be used. Click Submit to save your text to the origin window text field, or click Cancel to return to origin window without transferring text.</p> <p>The Heartbeat Message (header) string must be different from the Heartbeat Terminator string.</p> |
| Heartbeat Terminator (max. 32 chars) | <p>Click  to activate the Text Entry Tool and create Heartbeat Terminator text to signal the end of the heartbeat message. Characters from NUL (00H) to ~ (7EH) can be used. Click Submit to save your text to the origin window text field, or click Cancel to return to origin window without transferring text.</p> <p>The Heartbeat Terminator string must be different from the Heartbeat Message (header) string</p> |

Line Settings

| | |
|------------------|--|
| Baud Rate | Select a value from 1200 to 115200 from the drop-down list. Baud Rate is the transmission speed in a communication line. |
| Parity | Select None , Odd , or Even from the drop-down list. Parity is a parameter indicating the presence of a control bit in the communication protocol frame. |
| Data Bits | Select 7 or 8 from the drop-down list. Data Bits is a parameter indicating the number of bits composing the data packet of the communication protocol frame. |

| Field Name | Action/Definition |
|------------|---|
| Stop Bits | Select 1 or 2 from the drop-down list. Stop Bits is a parameter indicating the number of stop bits in the data packet of the communication protocol frame. |

- When you have finished making changes, click **Update All** to save all pending changes, click **Reset All** to revert to all previously saved values, and click **Reset Page** to revert to previous saved values on the current page.

4.5.5 Modify Settings | Global Settings | Ethernet

Use the **Ethernet** menu tree selections during initial setup to configure the Ethernet settings for your barcode scanning system.

Ethernet is the most popular physical layer LAN technology in use today. It is the IEEE 802.3 series standard, based on the CSMA/CD access method that provides two or more stations to share a common cabling system. This access method, Carrier Sense Multiple Access with Collision Detection, is the basis for Ethernet systems providing a wide range of speed.

The design goals for Ethernet are to create a simply defined topology that makes efficient use of shared resources that are easy to reconfigure and maintain and provides compatibility across many manufacturer and systems.

Ethernet supports many different network protocols; Datalogic scanners support IP plus TCP or UDP over Ethernet and 802.3 frame format as Ethernet protocol low level.

If necessary, you can later make modifications to the global system settings using the same menu selections, including:

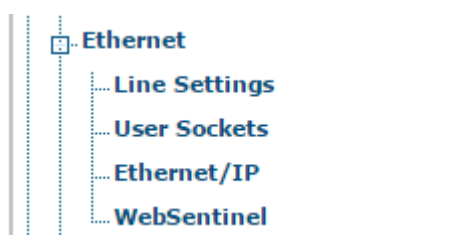

Modify Settings | Global Settings | Ethernet | Line Settings

Use the **Line Settings** window to define and report the fundamental information about the system.

To edit the Line Settings:

1. In the tree menu under Modify Settings, navigate to Global Settings | Ethernet | Line Settings. The Line Settings window opens.

The screenshot shows a configuration window with two main sections: **Host Network (ETH1)** and **Setup Network (ETH2)**. The **Host Network (ETH1)** section includes a checkbox for **Enable DHCP** (unchecked), and input fields for **IP Address** (10.27.152.192), **IP Netmask** (255.255.248.0), **IP Gateway** (10.27.152.21), **IP DNS1** (0.0.0.0), and **IP DNS2** (0.0.0.0). The **Setup Network (ETH2)** section includes input fields for **Setup IP Address** (192.168.3.101) and **Setup Netmask** (255.255.255.0). At the bottom, there are three buttons: **Update All**, **Reset All**, and **Reset Page**.

2. Enter the appropriate information in the form as described below:

| Field Name | Action/Definition |
|----------------------------|---|
| Host Network (ETH1) | |
| Enable DHCP | Select the check box to cause the IP address parameters to become inactive. They are then used to display the addresses assigned by a DHCP server when getting the scanner configuration. |
| IP Address | Enter the device Internet Protocol (IP) network address in the field provided. Consult your network administrator to obtain a new address. |
| IP Netmask | Enter the device subnet mask address in the field provided. Consult your network administrator to obtain a new address. |
| IP Gateway | Enter the device gateway address in the field provided. Consult your network administrator to obtain a new address. |
| IP DNS1 | Enter the address of the Primary Domain Name System (DNS) in the field provided. |
| IP DNS2 | Enter the address of the Secondary Domain Name System (DNS) in the field provided. |

| Field Name | Action/Definition |
|-----------------------------|--|
| Setup Network (ETH2) | |
| Setup IP Address | Enter the Internet Protocol (IP) network address for ETH2 (Setup) in the field provided. Consult your network administrator to obtain a new address. |
| Setup Netmask | Enter the subnet mask address for ETH2 (Setup) in the field provided. Consult your network administrator to obtain a new address. |

- When you have finished making changes, click **Update All** to save all pending changes, click **Reset All** to revert to all previously saved values, and click **Reset Page** to revert to previous saved values on the current page.

Modify Settings | Global Settings | Ethernet | User Sockets

Use the **User Sockets** (User Socket Settings) window to setup, edit, and configure numbered user sockets for your barcode scanning system. User sockets are another interface available for the Ethernet communication.

To edit the User Socket settings:

1. In the tree menu under **Modify Settings**, navigate to **Global Settings | Ethernet | User Sockets**. The User Sockets window opens.





2. Enter the appropriate information in the form as described below:

| Field Name | Action/Definition |
|---------------------------------|--|
| User Socket List | Select an option button in the list at the top of this window to create a new user socket, or to edit an existing one. |
| User Socket n | |
| Enable User Socket | Select the check box to enable User Sockets and reveal the related configuration options. |
| Enable Data Transmission | Select the check box to enable User Sockets and reveal the related configuration options. When enabled, Ethernet User Socket is selected as the channel to be used by the scanner for transmitting data and/or messages. |

| Field Name | Action/Definition |
|------------------|--|
| Heartbeat | <p>Select Disable, Enable Unconditioned, or Enable Conditioned from the drop-down list. This parameter is available when the Data TX parameter is checked. It enables/disables the transmission of the Heartbeat message signaling that the device is still active.</p> <ul style="list-style-type: none"> • Disable: The Heartbeat message is not transmitted • Enable Unconditioned: The Heartbeat message is always transmitted, even if communication is still active • Enable Conditioned: The Heartbeat message is transmitted only when there is no communication |

Heartbeat Settings

| | |
|---|---|
| Heartbeat Timeout | Enter a time value in seconds to define the amount of time between two message transmissions. If the input timeout expires and no transmission has occurred, the Heartbeat message will be transmitted. |
| Heartbeat Message (max. 32 chars) | <p>Click  to activate the Text Entry Tool and create heartbeat header text to signal the beginning of the heartbeat message. Characters from NUL (00H) to ~ (7EH) can be used. Click Submit to save your text to the origin window text field, or click Cancel to return to origin window without transferring text.</p> <p>The Heartbeat Message (header) string must be different from the Heartbeat Terminator string.</p> |
| Heartbeat Terminator (max. 32 chars) | <p>Click  to activate the Text Entry Tool and create Heartbeat Terminator text to signal the end of the heartbeat message. Characters from NUL (00H) to ~ (7EH) can be used. Click Submit to save your text to the origin window text field, or click Cancel to return to origin window without transferring text.</p> <p>The Heartbeat Terminator string must be different from the Heartbeat Message (header) string</p> |

| Field Name | Action/Definition |
|-----------------------------|-------------------|
| Socket Configuration | |

Type Select **Server** or **Client** from the drop-down list to define the type of the socket:

When the Protocol selected is TCP (see below):

- **Server:** The station waits for connections and can communicate with a maximum of 3 clients simultaneously.

The screenshot shows a 'Socket Configuration' form with the following fields: 'Type' is set to 'Server', 'Protocol' is set to 'TCP', and 'Port' is set to '51236'.

- **Client:** The station tries a connection towards the server.

The screenshot shows a 'Socket Configuration' form with the following fields: 'Type' is set to 'Client', 'Server Address' is set to '0.0.0.0', 'Protocol' is set to 'TCP', and 'Port' is set to '51236'.

When the Protocol selected is UDP (see below):

- **Server:** Special Datalogic mode in which the station waits to receive a message (content of message does not matter), and then responds with UDP host messages to that client. You must enter a port number, and if using a fixed UDP destination port, you must enter the number for that port as well.

The screenshot shows a 'Socket Configuration' form with the following fields: 'Type' is set to 'Server', 'Protocol' is set to 'UDP', 'Port' is set to '51236', 'Fixed UDP Destination Port' is checked, and 'UDP Destination Port' is set to '51242'.

- **Client:** Choose this option for standard UDP protocol. You must define the Server Address that will be receiving the UDP messages and port. If using a fixed UDP source port, you must enter the UDP source port number.

The screenshot shows a 'Socket Configuration' form with the following fields: 'Type' is set to 'Client', 'Server Address' is set to '0.0.0.0', 'Protocol' is set to 'UDP', 'Port' is set to '51236', 'Fixed UDP Source Port' is checked, and 'UDP Source Port' is set to '51248'.

| Field Name | Action/Definition |
|-----------------------------------|---|
| Server Address | Enter the IP address of the server to which the client tries to connect. This parameter is available only when the socket is configured as a Client . |
| Protocol | Select TCP (Transmission Control Protocol) or UDP (User Datagram Protocol) from the drop-down list to define the protocol to be used for the Ethernet communication. |
| | <div style="display: flex; align-items: center;">  <p>NOTE: When using the UDP protocol:</p> <ul style="list-style-type: none"> • The User Socket Client Port is bound to the Server Port. • The maximum size for maintaining a whole datagram is 1436 bytes, messages exceeding this value will be fragmented. </div> |
| Port | Enter the port number of the socket. |
| Fixed UDP Destination Port | When using UDP Server, select the check box to enable a fixed UDP destination port. |
| UDP Destination Port | When using UDP Server with a fixed UDP destination port, enter the port number. |
| Fixed UDP Source Port | When using UDP Client, select the check box to enable a fixed UDP source port. |
| UDP Source Port | When using UDP Client with a fixed UDP source port, enter the port number. |

3. When you have finished making changes, click **Update All** to save all pending changes, click **Reset All** to revert to all previously saved values, and click **Reset Page** to revert to previous saved values on the current page.

Modify Settings | Global Settings | Ethernet | Ethernet/IP

Use the **Ethernet I/P** window to set up digital inputs and outputs for the barcode scanner.

To enable or disable Ethernet/IP:

1. In the tree menu under **Modify Settings**, navigate to **Global Settings | Ethernet | Ethernet/IP**. The **Ethernet/IP** window opens.

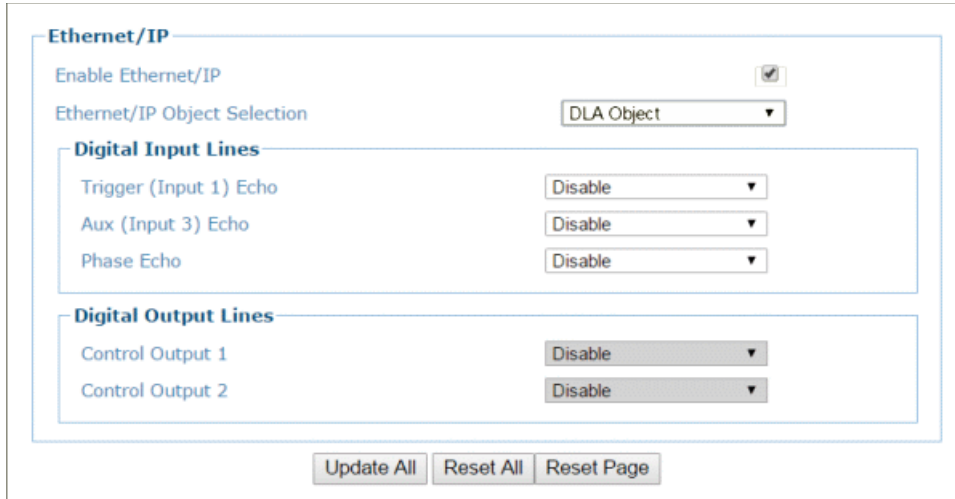

2. Enter the appropriate information in the form as described below:

| Field Name | Action/Definition |
|--|---|
| Enable Ethernet/IP | Select the check box to enable Ethernet/IP and reveal the related configuration options. |
| Ethernet/IP Object Selection | Select DLA Object or ASI Object from the drop-down list. Selection: <ul style="list-style-type: none"> • DLA Object - Refers to Datalogic Devices • ASI Object - Refers to legacy Accu-Sort Devices |
| Enable ControlLogix On-Demand Messaging | Select the check box to enable On-Demand Messaging when ASI Object is selected. On-Demand Messaging is a special option for communicating with ControlLogix/CompactLogix Controllers. When enabled, you must provide the Controller IP Address, the Slot number of the processor in the Controller and a Tag Name. To use On-Demand messaging, a tag of the same name is then defined on the ControlLogix/CompactLogix Controller and every time a bar code is read, the Bar Code object is transferred to the ControlLogix/CompactLogix Tag. |
| Digital Input Lines | |
| Trigger (Input 1) Echo | Select Disable or Enable from the drop-down list. If enabled, the Scanner Master or SC5000 Controller Trigger (Input 1) status is echoed to the Ethernet Client via bit 0 in Byte InputBits of the DL_InputStruct. |

| Field Name | Action/Definition |
|---------------------------|--|
| Aux (Input 3) Echo | Select Disable or Enable from the drop-down list. If enabled, the Scanner Master or SC5000 Controller Input 3 status is echoed to the Ethernet Client via bit 2 in Byte InputBits of the DL_InputStruct. |
| Phase Echo | This parameter is configurable only if Start Input from Bus is enabled. Select Disable or Enable from the drop-down list. If enabled, the Reading Phase status is echoed to the Ethernet Client via bit 7 in Byte InputBits of the DL_InputStruct. |

ASI Object: On-Demand Options



NOTE: Contact Datalogic Support for information on setting up ASI Objects (legacy Accu-Sort Devices). See Support Through the Website.

| | |
|------------------------|--|
| PLC IP Address | Enter the IP Address for the PLC Controller (Rockwell Automation: Allen-Bradley ControlLogix or CompactLogix). |
| Tag Name | Enter a tag name (up to 40 characters) in the field provided. |
| PLC Slot Number | Enter the PLC Slot number in the field provided. This corresponds to the physical slot used on the PLC. |

ASI Object: Message Options

| | |
|-----------------------|---|
| Message Format | Select ASCII or Binary from the drop-down list. Selections: <ul style="list-style-type: none"> ASCII - Select to transmit an ASCII barcode message (as defined by the Message Type). The only difference is that the Header and Trailer are omitted from the barcode messages transmitted using Ethernet/IP. When ASCII messages are in use, the Byte Swap ASCII Data selection will swap the high and low byte of data within each 16 bit word. This is useful for processing data on some Programmable Controllers. |
|-----------------------|---|

| Field Name | Action/Definition |
|----------------------------------|---|
| | <ul style="list-style-type: none"> • Binary - Select to convert barcode data to a “numeric value” and transferred as a 32 bit word. The user can specify the byte ordering of this word. If any non-numeric (not ASCII ‘0’ to ‘9’ or leading or trailing space) characters are contained in the barcode, the numeric value is zero. |
| ASCII Message Byte Swap | Select the check box to enable the function. Available when Binary is selected from the Message Format drop-down list. When ASCII messages are in use, the ASCII Message Byte Swap selection will swap the high and low byte of data within each 16 bit word. This is useful for processing data on some Programmable Controllers. |
| Binary Message Byte Order | Select Little Endian or Big Endian from the drop-down list. Available when Binary is selected from the Message Format drop-down list. |

Selection:

- **Little Endian:** The least significant byte (little end) of the data is positioned at the byte with the lowest address.
- **Big Endian:** The most significant byte (big end) of the data is positioned at the byte with the lowest address.

Digital Output Lines

| | |
|-------------------------|---|
| Control Output 1 | This parameter is configurable only if Digital Output 1 Use is set to Ethernet/IP. Select Disable or Enable from the drop-down list. If enabled, it allows the Ethernet Client to drive the Scanner Master or SC5000 Controller Output 1 via bit 0 in Byte OutputBits of the DL_OutputStruct. |
| Control Output 2 | This parameter is configurable only if Digital Output 2 Use is set to Ethernet/IP. Select Disable or Enable from the drop-down list. If enabled, it allows the Ethernet Client to drive the Scanner Master or SC5000 Controller Output 2 via bit 1 in Byte OutputBits of the DL_OutputStruct. |

3. When you have finished making changes, click **Update All** to save all pending changes, click **Reset All** to revert to all previously saved values, and click **Reset Page** to revert to previous saved values on the current page.

Modify Settings | Global Settings | Ethernet | WebSentinel

Use the **WebSentinel™** window to enable and configure the barcode scanner for use with Datalogic WebSentinel.

To enable or disable WebSentinel:

1. In the tree menu under **Modify Settings**, navigate to **Global Settings | Ethernet | WebSentinel**. The WebSentinel window opens.

2. Enter the appropriate information in the form as described below:

| Field Name | Action/Definition |
|---|---|
| Enable | Select the check box to enable WebSentinel and reveal the related configuration options. |
| WebSentinel Socket | Select a socket number for WebSentinel from those available in the drop-down list. |
| Monitor Settings | |
| Conveyor Speed Check Type | Select Percentage or Absolute from the drop-down list to determine how the conveyor speed is evaluated. |
| Max Conveyor Speed Percent Error (%) | In the text field provided, enter the percentage of discrepancy allowed in the conveyor speed before an error is sent. This option is available when Percentage is selected from the Conveyor Speed Check Type drop-down list . |
| Max Conveyor Speed Absolute Error (mm/s) | In the text field provided, enter the milliseconds of discrepancy allowed in the conveyor speed before an error is sent. This option is available when Absolute is selected from the Conveyor Speed Check Type drop-down list . |
| Input Timeout (secs) | Enter a time interval in seconds, after which the input will be checked for errors. If an error is found, it will be sent to WebSentinel. |

3. When you have finished making changes, click **Update All** to save all pending changes, click **Reset All** to revert to all previously saved values, and click **Reset Page** to revert to previous saved values on the current page.

4.5.6 Modify Settings | Global Settings | Fieldbus

Use the **Fieldbus** window to configure Fieldbus type communication between the scanner and Host, or, in a multi-sided layout, between several scanners and a Host.

To edit the Fieldbus settings:

1. In the tree menu under Modify Settings, navigate to **Global Settings | Fieldbus**. The Fieldbus window opens.

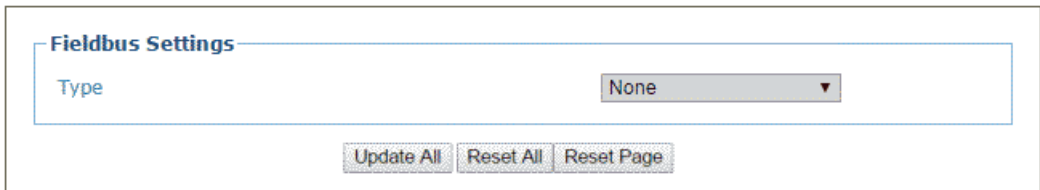

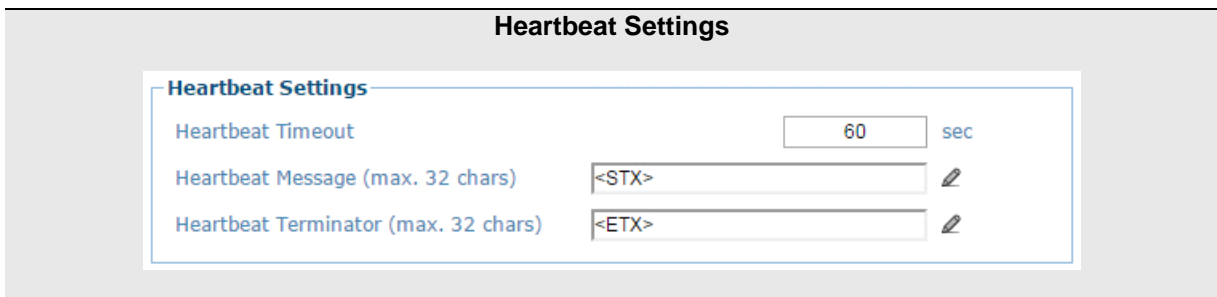

2. Enter the appropriate information in the form as described below:

| Field Name | Action/Definition |
|------------------|---|
| Type | Fieldbus type is displayed. When using the CBX510 with Fieldbus modules, select the correct Fieldbus Type. For SC5000, this option is preset and read-only based on the controller model used. |
| Data Tx | Select Enable or Disable from the drop-down list. If enabled, the fieldbus port is used by the scanner to transmit data and/or messages. |
| Heartbeat | <p>Select Disable, Enable Unconditioned, or Enable Conditioned from the drop-down list.</p> <p>This parameter is available when the Data TX parameter is checked. It enables/disables the transmission of the Heartbeat message signaling that the device is still active.</p> <ul style="list-style-type: none"> • Disable: The Heartbeat message is not transmitted • Enable Unconditioned: The Heartbeat message is always transmitted, even if communication is still active • Enable Conditioned: The Heartbeat message is transmitted only when there is no communication |



| | |
|--------------------------|---|
| Heartbeat Timeout | Enter a time value in seconds to define the amount of time between two message transmissions. If the input timeout expires and no transmission has occurred, the Heartbeat message will be transmitted. |
|--------------------------|---|

| Field Name | Action/Definition |
|---|--|
| Heartbeat Message (max. 32 chars) | <p>Click  to activate the Text Entry Tool and create heartbeat header text to signal the beginning of the heartbeat message. Characters from NUL (00H) to ~ (7EH) can be used.</p> <p>The Heartbeat Message (header) string must be different from the Heartbeat Terminator string.</p> |
| Heartbeat Terminator (max. 32 chars) | <p>Click  to activate the Text Entry Tool and create Heartbeat Terminator text to signal the end of the heartbeat message. Characters from NUL (00H) to ~ (7EH) can be used.</p> <p>The Heartbeat Terminator string must be different from the Heartbeat Message (header) string.</p> |

Flow Control Settings

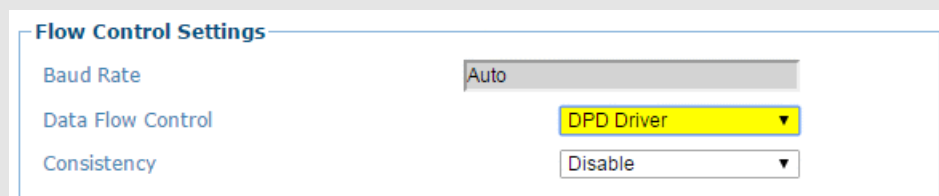

The screenshot shows a settings panel titled 'Flow Control Settings'. It contains three rows of settings:

- Baud Rate:** A text input field containing the value 'Auto'.
- Data Flow Control:** A dropdown menu with 'DPD Driver' selected and highlighted in yellow.
- Consistency:** A dropdown menu with 'Disable' selected.

| | |
|--------------------------|--|
| Baud Rate | This is a read-only parameter. The default value Auto allows the Host to control the data transmission speed of the Profibus network. |
| Data Flow Control | Select Disable , DAD Driver , or DPD Driver from the drop-down list. This implements a reliable transmission protocol between Fieldbus Master (PLC) and Fieldbus Slave (SC5000 or Scanner Master) allowing specific functions such as Synchronization, Fragmentation/Reassembling and Data Consistency. |
| Consistency | Select Disable or Enable from the drop-down list. This parameter is available only when the Data Flow Control parameter is set to DAD or DPD Driver. If enabled, it allows improving the overall communication robustness of the Fieldbus network. |

Profibus Settings

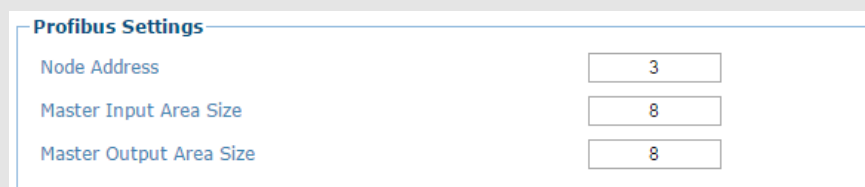

The screenshot shows a settings panel titled 'Profibus Settings'. It contains three rows of settings, each with a text input field:

- Node Address:** Input field containing the value '3'.
- Master Input Area Size:** Input field containing the value '8'.
- Master Output Area Size:** Input field containing the value '8'.

| | |
|-------------------------------|--|
| Node Address | <p>Enter a node value in the field provided, to define the value that distinguishes this node from all other nodes on the same link. Each node identifies a device within the network.</p> <p>Valid values are in the range 0 - 126.</p> <p>Node Address 126 forces the SSA (Set Station Address) service which allows the Fieldbus Master to assign the slave node address.</p> |
| Master Input Area Size | <p>Enter a value from 8 - 144 bytes to define the size of the message command sent from the Fieldbus module to the Fieldbus Master (Host). The default value is 8 bytes.</p> <p>The maximum Input + Output Area Size for the Profibus interface is 152 bytes.</p> |

| Field Name | Action/Definition |
|--------------------------------|---|
| Master Output Area Size | Enter a value from 8 – 144 bytes to define the size of the message command sent to the Fieldbus module from the Fieldbus Master (Host). The default value is 8 bytes. |

The maximum Input + Output Area Size for the Profibus interface is 152 bytes.

Profinet Settings

Profinet Settings

Master Input Area Size

Master Output Area Size

Profinet Ethernet Settings

Station Name (max. 32 chars)

MAC Address

MAC Address 1

MAC Address 2

Ethernet Bus Rate

IP Addressing

IP Address

IP Net Mask

IP Gateway

| | |
|-------------------------------|--|
| Master Input Area Size | Enter a value from 8 - 56 bytes to define the size of the message command sent from the Fieldbus module to the Fieldbus Master (Host). The default value is 8 bytes. |
|-------------------------------|--|

The maximum Input + Output Area Size for the Profinet interface is 64 bytes.

| | |
|--------------------------------|--|
| Master Output Area Size | Enter a value from 8 – 56 bytes to define the size of the message command sent to the Fieldbus module from the Fieldbus Master (Host). The default value is 8 bytes. |
|--------------------------------|--|

The maximum Input + Output Area Size for the Profinet interface is 64 bytes.

| | |
|-------------------------------------|---|
| Station Name (max. 32 chars) | This string identifies the node on the network as an alternative to the IP address. If this value is changed by the host application during runtime, a reset is required in order for changes to have effect. |
|-------------------------------------|---|

The name can be made up only of letters or numbers. The . (dot) and - (dash) characters can be used but not as the first or last character in the name.

The default name is Datalogic.

| | |
|--------------------|---|
| MAC Address | This is a read-only parameter. It displays the address of the Profinet channel reserved for internal communication. |
|--------------------|---|

| | |
|----------------------|---|
| MAC Address 1 | This is a read-only parameter. It displays the address of one of the Profinet channels to be used for Host communication. |
|----------------------|---|

| | |
|----------------------|---|
| MAC Address 2 | This is a read-only parameter. It displays the address of one of the Profinet channels to be used for Host communication. |
|----------------------|---|

| Field Name | Action/Definition |
|--------------------------|--|
| Ethernet Bus Rate | This is a read-only parameter. The bus rate is set to Auto allowing the Host to manage the bus speed. |
| IP Addressing | <p>Static: the IP Address can be set manually through the IP Address, IP Net Mask and IP Gateway parameters.</p> <p>DHCP: the IP address is assigned by a DHCP server. In this case the IP Address parameters are read-only and display the DHCP assigned address.</p> <p>Remote: the IP Address is assigned by a remote network device (PC) using an IPConfig address configuration application. In this case the IP address parameters are read-only and display the remotely assigned address.</p> |
| IP Address | Enter the device Internet Protocol (IP) network address in the field provided. Consult your network administrator to obtain a new address. |
| IP Net Mask | Enter the device subnet mask address in the field provided. Consult your network administrator to obtain a new address. |
| IP Gateway | Enter the device gateway address in the field provided. Consult your network administrator to obtain a new address. |

Digital Input Lines

Digital Input Lines

| | |
|------------------------|-----------|
| Trigger (Input 1) Echo | Disable ▼ |
| Aux (Input 3) Echo | Disable ▼ |
| Phase Echo | Disable ▼ |



NOTE: If any of the following parameters are enabled, the **Data Flow Control** DAD/DPD Driver starts at Byte 1 (second byte) of the Fieldbus Master Input Area, and Byte 0 (first byte) is reserved for these Digital Input Line Echo parameters.

If none of the following parameters are enabled, the **Data Flow Control** DAD/DPD Driver starts at Byte 0 (first byte) of the Fieldbus Master Input Area.

For more details, refer to the DAD/DPD Driver Reference Manual.

| | |
|-------------------------------|--|
| Trigger (Input 1) Echo | Select Disable or Enable from the drop-down list. If enabled, the Scanner Master or SC5000 Controller Trigger (Input 1) status is echoed to the Fieldbus Master via bit 0 in Byte 0 (first byte) of the Input Area. |
| Aux (Input 3) Echo | Select Disable or Enable from the drop-down list. If enabled, the Scanner Master or SC5000 Controller Input 3 status is echoed to the Fieldbus Master via bit 2 in Byte 0 (first byte) of the Input Area. |
| Phase Echo | This parameter is configurable only if Start Input from Bus is enabled. Select Disable or Enable from the drop-down list. If enabled, the Reading Phase status is echoed to the Fieldbus Master via bit 7 in Byte 0 (first byte) of the Input Area. |

| Field Name | Action/Definition |
|------------|-------------------|
|------------|-------------------|

Digital Output Lines

Digital Output Lines

| | |
|------------------|-----------|
| Control Output 1 | Disable ▼ |
| Control Output 2 | Disable ▼ |



NOTE: If any of the following parameters are enabled, the **Data Flow Control** DAD/DPD Driver starts at Byte 1 (second byte) of the Fieldbus Master Output Area, and Byte 0 (first byte) is reserved for these Digital Output Line parameters.

If none of the following parameters are enabled, the **Data Flow Control** DAD/DPD Driver starts at Byte 0 (first byte) of the Fieldbus Master Output Area.

For more details, refer to the DAD/DPD Driver Reference Manual.

| | |
|-------------------------|---|
| Control Output 1 | This parameter is configurable only if Digital Output 1 Use is set to Profibus/Profinet. Select Disable or Enable from the drop-down list. If enabled, it allows the Fieldbus Master to drive the Scanner Master or SC5000 Controller Output 1 via bit 0 in Byte 0 (first byte) of the Output Area. |
| Control Output 2 | This parameter is configurable only if Digital Output 2 Use is set to Profibus/Profinet. Select Disable or Enable from the drop-down list. If enabled, it allows the Fieldbus Master to drive the Scanner Master or SC5000 Controller Output 2 via bit 1 in Byte 0 (first byte) of the Output Area. |

- When you have finished making changes, click **Update All** to save all pending changes, click **Reset All** to revert to all previously saved values, and click **Reset Page** to revert to previous saved values on the current page.

4.5.7 Modify Settings | Global Settings | Messaging

Use the Messaging selections during initial setup to configure system messaging for your **DS8110/DX8210 barcode scanner**. If necessary, you can later make modifications to the configuration using the same menu selections, including:

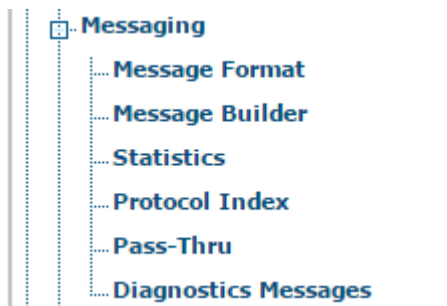

Modify Settings | Global Settings | Messaging | Message Format

Use the **Message Format** window to configure Standard or Advanced system messages.

To edit the **Message Format** settings:

1. In the tree menu under **Modify Settings**, navigate to **Global Settings | Messaging | Message Format**. The **Message Format** window opens.

A screenshot of the "Message Formatting" configuration window. The window is divided into two main sections: "Standard Format" and "Advanced Format".

Standard Format Section:

- Special Host Protocol: None (dropdown)
- Message Format: Standard (dropdown)
- Message Tx Selection: After Reading Phase C (dropdown)
- Max. Tx Delay after Phase Off: 100 msec (dropdown)
- Header Tx Start: With Data (dropdown)
- Termination After No Read Message: Enable (dropdown)
- Header String (max. 128 chars): <STX> (text input with edit icon)
- Termination String (max. 128 chars): <CR><LF> (text input with edit icon)
- Data Packet Separators (max. 128 chars): (text input with edit icon)
- Code Position Tx: (checkbox, unchecked)
- Code Direction Identifier Enable: (checkbox, unchecked)
- Code Field Length Setting: Variable Length (dropdown)
- Code Identifier: Disabled (dropdown)

Advanced Format Section: (This section is currently collapsed and not visible in the screenshot).

At the bottom of the window, there are three buttons: "Update All", "Reset All", and "Reset Page".

2. Enter the appropriate information in the form as described below:

| Field Name | Action/Definition |
|---|--|
| Messaging Formatting | |
| Special Host Protocol | Select None or a specific custom protocol from the drop-down list. In some cases, a customer specific protocol may have been created. When selected, a group of options specific to that protocol are made available. |
| Crisplant Protocol | |
| Port to Use | Select Aux Serial Port , Main Serial Port , or a User Socket from the drop-down list. |
| Crisplant Device Type/Error Definition | Select DLA Device/Errors or a ASI-Axiom/Errors from the drop-down list. This allows selection of different device types, as the error codes required by Crisplant vary from device to device. DLA Device/Errors: select when using current Datalogic devices ASI-Axiom/Errors: Select when using legacy Accu-Sort devices |
| Crisplant Manufacturer ID | This field is determined by the Crisplant Device Type/Error Definition selected above and cannot be edited. This defines the "Scanner Identity" byte of the Error and Heartbeat messages of the Crisplant Protocol. |
| Heartbeat Message Enable | Select the check box to enable the transmission of the Heartbeat message. |
| Heartbeat Message Timing | Enter a value in milliseconds to define the amount of time between two code transmissions. If the selected timeout expires and no transmission has occurred, the Heartbeat message will be transmitted. |
| Crisplant Protocol Type | Select CSC , CMC , or P10 from the drop-down list. This defines the type of Crisplant protocol to be used: CSC: the <CR><LF> characters do not appear at the end of transmitted/received telegrams CMC: the <CR><LF> characters appear at the end of transmitted/received telegrams P10: <ul style="list-style-type: none"> • the <CR><LF> characters appear at the end of transmitted/received telegrams • the Parameter Crisplant Manufacturer ID is forced to the Value 'a' (61H) and cannot be modified for this selection • the error messages are modified with respect to CSC and CMC protocols |
| Discard Read on Missing Index | Select the check box to enable. When selected, if a Missed Index error occurs, an empty telegram is sent to the Crisplant Host. If not selected, and a Missed Index error occurs, the telegram contains the codes that were read relative to the pack. |

| Field Name | Action/Definition |
|------------|-------------------|
|------------|-------------------|

| Mettler Toledo Protocol | |
|-------------------------|--|
|-------------------------|--|

| | |
|---------------------------------|---|
| Conveyer Direction Input | Select Trigger (Input 1) or Aux (Input 3) from the drop-down list. The selection defines which digital input transmits information about the conveyer direction. The conveyer direction is Forward when the selected input is active (default active closed). If Input 1 is used the scanner Phase On LED also signals the direction state. |
|---------------------------------|---|

| | |
|------------------------------------|--|
| SW Divide Encoder Frequency | Select the check box to enable. If selected, the encoder frequency value is divided by two before it is transmitted to the Host. This parameter only effects the value contained in the <Encoder> field of the messages sent from the scanner to the Host. |
|------------------------------------|--|

| Message Definition | |
|--------------------|--|
|--------------------|--|

| | |
|---------------|---|
| Header | Enter a message header in the field provided. A Header (up to 128 bytes) can be defined and transmitted as a block preceding all messages sent from the scanner. Character from NUL (00H) to ~ (7EH) can be used. |
|---------------|---|

| | |
|----------------|---|
| Trailer | Enter a message trailer in the field provided. A Trailer (up to 128 bytes) can be defined and transmitted as a block following all messages sent from the scanner. Character from NUL (00H) to ~ (7EH) can be used. |
|----------------|---|

| | |
|-------------------------|---|
| Heartbeat Enable | Select the check box to enable heartbeat. |
|-------------------------|---|

| | |
|--------------------------|---|
| Heartbeat Timeout | Enter a value in milliseconds. This parameter is available when the Heartbeat parameter is enabled. It defines the amount of time between two message transmissions. If the selected timeout expires and no transmission has occurred, the Heartbeat message will be transmitted. |
|--------------------------|---|

| | |
|--------------------------|--|
| Heartbeat Message | Click  to activate the Text Entry Tool and create a heartbeat message in the field provided. This parameter is available only when the Heartbeat parameter is enabled. This defines the Heartbeat message. |
|--------------------------|--|

Click **Submit** to save your changes, or click **Cancel** to return to previous.

Field Name Action/Definition

| | |
|----------------------------------|---|
| Code Field Length Setting | <p>Select Fixed Length or Variable Length from the drop-down list. This parameter is applied only to the <Barcode> field contained in two specific messages (Barcode information and Diagnostics) of the protocol. The code field length (in number of characters/digits) can be specified in order to be transmitted:</p> |
| | <p>Selections:</p> <ul style="list-style-type: none"> • Variable: All possible code field lengths (in number of characters/digits) allowed for the code selected are accepted • Fixed: The code is entirely transmitted even if it is longer than the defined length. If shorter, it will be transmitted with the addition of the Fill Character. |
| Data Justification | <p>Select Left or Right from the drop-down list. This parameter is applied only to the <Barcode> field contained in two specific messages (Barcode information and Diagnostics) of the protocol. It is available when the Code Field Length Setting is set to Fixed. This defines the position of the Fill Character within the code:</p> |
| | <p>Selections:</p> <ul style="list-style-type: none"> • Left: Fill Character is left aligned and precedes the <Barcode> field • Right: Fill Character is right aligned and follows the <Barcode> field |
| Code Field Length | <p>Enter a length in the field provided. This parameter is applied only to the <Barcode> field contained in two specific messages (Barcode information and Diagnostics) of the protocol. It is available when the Code Field Length Setting is set to Fixed.</p> <p>This defines (in number of characters/digits) the length of the <Barcode> field to be transmitted in a value range from 0 to 48.</p> |
| Fill Character | <p>Click  to activate the Text Entry Tool and create a fill character in the field provided. This parameter is applied only to the <Barcode> field contained in two specific messages (Barcode information and Diagnostics) of the protocol. It is available when the Code Field Length Setting is set to Fixed. The Fill Character is inserted into each character position of a code field that has more characters (as defined in the Code Field Length) than exist in the barcode read. A character from NUL (00H) to ~ (7EH) can be used.</p> <p>Click Submit to save your changes, or click Cancel to return to previous.</p> |

| Field Name | Action/Definition |
|--------------------------|---|
| Add AIM Prefix | Select check box to enable. If enabled, it adds the AIM standard prefix to the barcode to be sent to the host. No separator character will be added between the AIM prefix and the barcode. |
| AM/PM Behavior | <p>Select the check box to enable. If enabled, the Host is ready to receive the following message:</p> <p style="text-align: center;"><STX><COMMAND><ETX></p> <p>where:</p> <p><COMMAND> = 'A' indicates that the Host starts working in AM mode / 'P' indicates that the Host starts working in PM (default) mode</p> <p>When working in AM mode:</p> <ul style="list-style-type: none"> • each code is only filtered by the Encoder Timeout parameter; • the Purolator Custom Check parameter is not effective; • the Heartbeat message will never be transmitted; • the transmitted message is not subject to padding with the Fill Character. <p>and the output message format is the following:</p> <p><STX><scanner_nr><space><barcode><ETX><CR><LF></p> <p>where:</p> <p><scanner_nr> = 2-digit number in the range 00-31</p> |
| AM Message Target | Select Main Serial Port, Aux Serial Port, or a User Socket from the drop-down list. |

Field Name Action/Definition

Multi-Tx Transport Disable This parameter manages the message transmission through the different communication channels.

If unchecked (check box not selected), messages are transmitted through all the communication channels having the Data Tx parameter enabled.

If checked (check box selected), messages are sent through all the communication channels having the Data Tx parameter enabled until the scanner receives one of the three possible communication messages (Status Request, Encoder Counter Request, Initialization Command). As soon as this condition occurs, all messages will be transmitted only through the specific channel sending one of the three possible communication messages while other channels are ignored. In this way, the last channel sending one of the possible communication messages will become the one used for transmission.

Spontaneous Status Message Select check box to enable. In case of diagnostic errors, this message is sent every 40 seconds.

Purolator Custom Check Select the check box to enable. If enabled, all service labels sharing the following characteristics will not be filtered by the Code Filter Depth and Encoder Timeout parameters:

- all service labels containing 2 characters only (e.g. "F1", "F2", ecc);
- all service labels of 8 characters starting with "ENP";
- all service labels of 9 characters starting with "OSNR".

Code Filter

Enable UPS Code Filter Select the check box to enable. If selected, the UPS Code Filters, PTN Code Filters, and Postal Code Filters panels open.

UPS Code Filters

Tracking Label - Starts with '1Z' Select check box to enable. If selected, function allows the transmission of codes belonging to the Code 128 and Code 39 families starting with '1Z', '3Z', '1B' or '3B'. The length of these codes is 18 digits.

| Field Name | Action/Definition |
|--|---|
| Service Upgrade Label - Starts with '403', Length is 8 | Select check box to enable. If selected, function allows the transmission of codes belonging to the Code 128 and Code 39 families starting with '403'. The length of these codes is 8 digits. |
| PTN Code Filters | |
| Select all codes of PTN type, except codes below (that must be selected) | Select check box to enable. If selected, it is possible to transmit all Code 128 and Code 39 codes belonging to this type having a length of 11 digits with the exception of those starting with: - '400', '420', '421', '51L', '52L', '54L', '55L' |
| Starts with... | Select each check box to enable/include that prefix. |
| Postal Code Filters | |
| Starts with... | Select each check box to enable/include that prefix. This allows the transmission of codes belonging to the Code 128 and Code 39 families having any of the following selected characteristics: <ul style="list-style-type: none"> • starting with '420' and with length 8 or 12 digits • starting with '421' and with length from 6 to 15 digits • starting with '51L' and with length 8, 9 or 12 digits • starting with '52L' and with length 8, 9 or 12 digits • starting with '54L' and with length from 6 to 19 digits • starting with '55L' and with length from 6 to 19 digits |
| Enable DPD Code Filter | Select the check box to enable the DPD Code Filters panel. The DPD Code Filters panel allows selection of the DPD code to be transmitted. All codes different from the selected DPD will also be transmitted. |

| Field Name | Action/Definition |
|---------------------------------------|---|
| Enable SSCC-18 Code Filter | Select the check box to enable. If selected, only the GS1-128 code, type SSCC-18, of the Code 128 family is transmitted. All codes different from the GS1-128, type SSCC-18, will also be transmitted. |
| Enable German Post 2/5 IL Code Filter | Select the check box to enable. If selected, only the German Post codes of the 2/5 Interleaved code family are transmitted. All code families different from the 2/5 Interleaved will also be transmitted. |
| Diagnostic Messages | <p>Select the check boxes as needed to enable. If selected, these parameters allow selecting the desired communication channel (Main, Aux, User Socket#n) to be used for transmitting barcode messages coming from slaves.</p> <p>The selection is available only if the desired communication channel is free (Data TX parameter disabled).</p> <p>The diagnostic data format can be defined through the commands provided by a terminal interface.</p> |
| Debug Messages | <p>Select the check boxes as needed to enable. If selected, these parameters allow selecting the desired communication channel (Main, Aux, User Socket#n) to be used for transmitting debug messages coming from slaves.</p> <p>The selection is available only if the desired communication channel is free (Data TX parameter disabled).</p> |
| DPD Code Filters | <p>If DPD Code Filter is enabled, the user can select the DPD code to be transmitted by selecting its check box. All codes different from the selected DPD will also be transmitted.</p> <p>This group allows selecting the DPD code type(s) to be transmitted. These codes belong to the Interleaved 2/5 or Code 128 family and have one of the following characteristics:</p> <ul style="list-style-type: none"> • I2of5 Code, Length is 10 • I2of5 Code, Length is 12 • I2of5 Code, Starts with '0', Length is 4 • I2of5 Code, starts with '90', Length is 4 • Code 128, Length is 28 <p>All codes belonging to code families other than Interleaved 2/5 and Code 128 will be also transmitted.</p> |

| Field Name | Action/Definition |
|------------|-------------------|
|------------|-------------------|

| | |
|-----------------------|---|
| Message Format | Select Standard or Advanced from the Format Type drop-down list. |
|-----------------------|---|

| | |
|-----------------------------|--|
| Message Tx Selection | Select On Decoding or After Reading Phase Off from the drop-down list. Message Tx selects the transmission of the output message on decoding or after the reading phase as illustrated below. |
|-----------------------------|--|

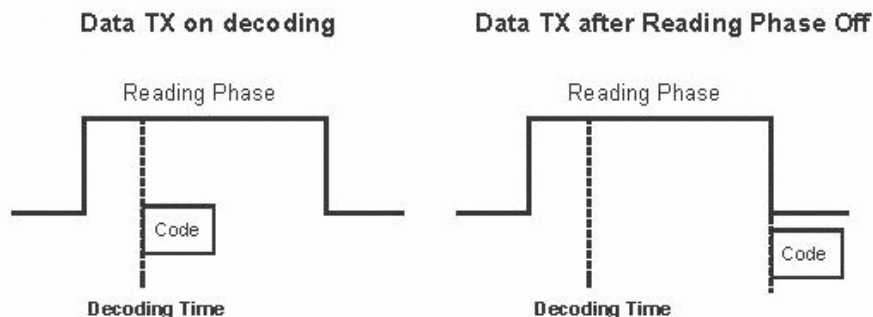

NOTE: This option is only available when an **Operating Mode** of **On Line** is selected in **Modify Settings | Global Settings | Operating Mode**.

| | |
|--------------------------------------|--|
| Max. Tx Delay after Phase Off | Select Disabled or a millisecond value (50 to 500 msec) from the drop-down list. This parameter defines a timeout, which is the maximum delay allowable for message transmission after the reading phase is closed. If this timeout expires before message transmission, the message will be discarded. |
|--------------------------------------|--|



NOTE: This option is only available when an **Operating Mode** of **On Line** is selected in **Modify Settings | Global Settings | Operating Mode**.

| | |
|------------------------|---|
| Header Tx Start | Select With Data or After Reading Phase On from the drop-down list. If With Data is selected, the header will be transmitted with data. If After Reading Phase On is selected, the header will be transmitted after the reading phase activation. See illustration below: |
|------------------------|---|

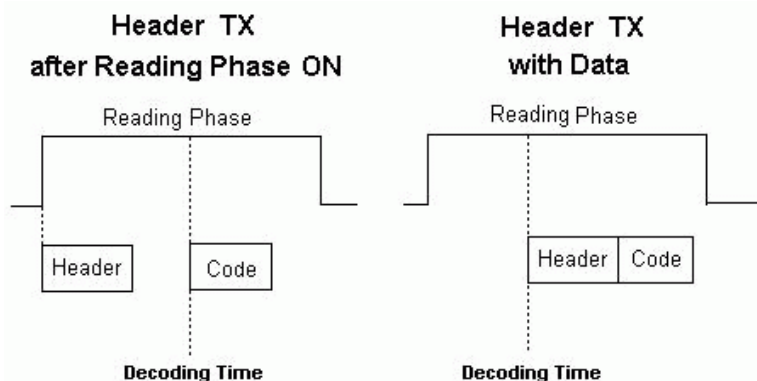

NOTE: This option is only available when an **Operating Mode** of **On Line** is selected in **Modify Settings | Global Settings | Operating Mode**.

| Field Name | Action/Definition |
|------------|-------------------|
|------------|-------------------|

| | |
|--|--|
| Termination After No Read Message | Select Enable or Disable from the drop-down list. If Enable is selected, a termination string is added to the No Read message string. |
|--|--|



NOTE: This option is only available when an **Operating Mode** of **On Line** is selected in **Modify Settings | Global Settings | Operating Mode**.

| Format Type: Standard | |
|-----------------------|--|
|-----------------------|--|

| | |
|----------------------|--|
| Header String | <p>Click  to activate the Text Entry Tool and create a Header String in the text field provided. Headers (up to 128 bytes) can be defined and transmitted as a block preceding the barcode(s). Use characters from NUL (00H) to ~ (7EH).</p> <p>Click Submit to save your text to the origin window text field, or click Cancel to return to origin window without transferring text.</p> |
|----------------------|--|

| | |
|---------------------------|--|
| Termination String | <p>Click  to activate the Text Entry Tool and create a Termination String in the text field provided. Terminators (up to 128 bytes) can be defined and transmitted as a block following the barcode(s). Use characters from NUL (00H) to ~ (7EH). Click Submit to save your text to the origin window text field, or click Cancel to return to origin window without transferring text.</p> |
|---------------------------|--|

| | |
|-------------------------------|---|
| Data Packet Separators | <p>Click  to activate the Text Entry Tool and create a Data Packet Separators in the text field provided. The Data Packet Separators (up to 128 bytes) are used to separate barcodes in the reading phase. Use characters from NUL (00H) to ~ (7EH).</p> <p>For this reason, it is very useful when the Standard Multi Label, Code Collection or Code Combination parameters have been selected in the Barcode Configuration. If selected, they occur within the Code Field and are transmitted after each decoded code.</p> <p>Click Submit to save your text to the origin window text field, or click Cancel to return to origin window without transferring text.</p> |
|-------------------------------|---|

| | |
|-------------------------|--|
| Code Position Tx | Select the check box to enable. If enabled, the code position information is included in the output data format. |
|-------------------------|--|

| | |
|---|---|
| Code Direction Identifier Enable | Select the check box to enable. If enabled, it allows you to define the forward and reverse strings indicating the scanning direction with respect to the code direction. |
|---|---|

| | |
|---------------------------------|---|
| Forward Direction String | <p>Click  to activate the Text Entry Tool and create a Forward Direction String in the text field provided. A Forward Direction String can be included in the output message to indicate that the current code has been scanned in the forward direction (scanning from left to right).</p> <p>This string ("+" is the default value) can be customized by the user including up to 32 characters.</p> <p>Click Submit to save your text to the origin window text field, or click Cancel to return to origin window without transferring text.</p> |
|---------------------------------|---|

Field Name Action/Definition

Code Identifier Select **Disable**, **Standard AIM ID**, or **User Specified** from the drop-down list. A **Code Identifier** string can be included in the output message.

- If **Disable** is selected, no code identifier is included in the output message.
- If **Standard AIM ID** is selected, the AIM standard identifier is included in the output message
- If **User Specified** is selected, the **Code Identifier Strings** group is activated at the bottom of the window, allowing you to define an identifier string for each code symbology. The string will be included in the output message.

Code Identifier Strings

This section of the Message Format window is only available when **User Specified** is selected as the **Code Identifier**. Click  to activate the Text Entry Tool and create a custom code identifier string for any listed code symbology. Click **Submit** to save your text to the origin window text field, or click **Cancel** to return to origin window without transferring text.

Code Identifier User Specified ▼

Code Identifier Strings (max 32 chars)

| | |
|---------------------------------------|---|
| Code 128 Identifier String | C0 <input style="width: 100px;" type="text"/>  |
| Interleaved 2/5 Identifier String | I0 <input style="width: 100px;" type="text"/>  |
| Code 39 Identifier String | A0 <input style="width: 100px;" type="text"/>  |
| Code 93 Identifier String | G0 <input style="width: 100px;" type="text"/>  |
| Codabar Identifier String | F0 <input style="width: 100px;" type="text"/>  |
| GS1-128 (ex EAN128) Identifier String | C1 <input style="width: 100px;" type="text"/>  |
| EAN13 Identifier String | E0 <input style="width: 100px;" type="text"/>  |
| EAN13 + Add-on 2 Identifier String | E1 <input style="width: 100px;" type="text"/>  |
| EAN13 + Add-on 5 Identifier String | E2 <input style="width: 100px;" type="text"/>  |
| EAN-8 Identifier String | E4 <input style="width: 100px;" type="text"/>  |
| EAN-8 + Add-on 2 Identifier String | E5 <input style="width: 100px;" type="text"/>  |
| EAN-8 + Add-on 5 Identifier String | E6 <input style="width: 100px;" type="text"/>  |
| UPC-A Identifier String | E0 <input style="width: 100px;" type="text"/>  |
| UPC-A + Add-on 2 Identifier String | E1 <input style="width: 100px;" type="text"/>  |
| UPC-A + Add-on 5 Identifier String | E2 <input style="width: 100px;" type="text"/>  |
| UPC-E Identifier String | E7 <input style="width: 100px;" type="text"/>  |
| UPC-E + Add-on 2 Identifier String | E8 <input style="width: 100px;" type="text"/>  |
| UPC-E + Add-on 5 Identifier String | E9 <input style="width: 100px;" type="text"/>  |

Field Name Action/Definition

Format Type: Advanced

Messaging Formatting

Special Host Protocol: None

Message Format: Advanced

Message Tx Selection: After Reading Phase O

Maximum Tx Delay after Phase Off: 100 msec

Header Tx Start: With Data

Termination After No Read Message: Enable

Advanced Format

Select an Message Number to Modify: 1

Advanced Format: Message Definition 1

Message Destination

| | | | | | |
|------------------|-------------------------------------|-----------------|--------------------------|---------------|-------------------------------------|
| Main Serial Port | <input checked="" type="checkbox"/> | Aux Serial Port | <input type="checkbox"/> | User Socket 1 | <input checked="" type="checkbox"/> |
| User Socket 2 | <input type="checkbox"/> | User Socket 3 | <input type="checkbox"/> | User Socket 4 | <input type="checkbox"/> |
| User Socket 5 | <input type="checkbox"/> | User Socket 6 | <input type="checkbox"/> | EtherNet/IP | <input type="checkbox"/> |
| Profibus | <input type="checkbox"/> | Profinet | <input type="checkbox"/> | | |

Message Destination Bitmap: 8193

Message Alignment: Left

Align Length: 0

Align Filler Char: <SPC>

Header: <STX>

Terminator: <CR><LF>

Message Location for Global No Read: Only No Read Message

Global Scale Type (Units): Metric (mm)

Code Identifier: Disabled

[Message Builder](#)

Update All Reset All Reset Page

Select a Message Number to Modify Select a numbered message you wish to modify from the drop-down list.





Advanced Format: Message Definition *n*

Message Destination Select the check box for each port or socket that should receive the message.

Message Destination Bitmap Indicates the destination of the message.

Message Alignment Select **None**, **Left**, or **Right** from the drop-down list.

Align Length Enter the number of characters by which to extend the message when **Left** or **Right** is selected from the **Message Alignment** drop-down box.

| Field Name | Action/Definition |
|--|--|
| Align Filler Char | Click  to activate the Text Entry Tool and create a filler character in the text field provided. This filler is used to extend the Align Length . |
| Header | Click  to activate the Text Entry Tool and create a Header in the text field provided. Headers (up to 128 bytes) can be defined and transmitted as a block preceding the barcode(s). Use characters from NUL (00H) to ~ (7EH). Click Submit to save your text to the origin window text field, or click Cancel to return to origin window without transferring text. |
| Terminator | Click  to activate the Text Entry Tool and create a Terminator in the text field provided. Terminators (up to 128 bytes) can be defined and transmitted as a block following the barcode(s). Use characters from NUL (00H) to ~ (7EH). Click Submit to save your text to the origin window text field, or click Cancel to return to origin window without transferring text. |
| Message Location for Global No Read | Select Only No Read Message , Before No Read Message , or After No Read Message from the drop-down list. |
| Global Scale Type (Units) | Select Metric (mm) or Imperial (0.1 in) from the drop-down list. |
| Code Identifier | Select Disable , AIM , or Custom from the drop-down list. A Code Identifier string can be included in the output message. <ul style="list-style-type: none"> • If Disable is selected, no code identifier is included in the output message. • If AIM is selected, the AIM standard identifier is included in the output message • If Custom is selected, the Code Identifier Strings group is activated at the bottom of the window, allowing you to define an identifier string for each code symbology. The string will be included in the output message. <div style="text-align: center; background-color: #e0e0e0; padding: 5px; margin: 10px 0;">Code Identifier Strings</div> <p>This section of the Message Format window is only available when Custom is selected as the Code Identifier. Click  to activate the Text Entry Tool and create a custom code identifier string for any listed code symbology.</p> <p>Click Submit to save your text to the origin window text field, or click Cancel to return to origin window without transferring text.</p> |

- When you have finished making changes, click **Update All** to save all pending changes, click **Reset All** to revert to all previously saved values, and click **Reset Page** to revert to previous saved values on the current page.

Modify Settings | Global Settings | Messaging | Message Builder

Use the **Message Builder** window to create Standard or Advanced system messages.

To use the Message Builder:

1. In the tree menu under Modify Settings, navigate to **Global Settings | Messaging | Message Builder**. The **Message Builder** window opens.

Advanced Format - Message Builder

Message Number to Modify: 1

Message 1 Item List

| Idx | Type | Qualifier |
|-----|-------------|--------------|
| 8 | Text String | mm, |
| 9 | X Position | 1 - Code 128 |
| 10 | Text String | in, |
| 11 | Z Position | 1 - Code 128 |
| 12 | Text String | in |

Buttons: Add, Add before, Add after, Move up, Move down, Remove

Item 12 Definition

Item Type: Text String

String Field: in

Options: Link to Code: Disabled

Buttons: Update All, Reset All, Reset Page

2. Enter the appropriate information in the form as described below:

| Field Name | Action/Definition |
|-----------------------------------|--|
| Message Number to Modify | Select the number of the message you want to modify from the drop-down list. |
| Message <i>n</i> Item List | |
| Idx | Displays the index number of the messages. |
| Type | Displays the message type including various Text String , Code Related Item , or Package Related Item messages. |
| Qualifier | Displays relevant qualifiers for the message item if needed. |
| Add | Click to add a message item to the bottom of the list. |
| Add before | Click to add a message item above the currently selected message. |
| Add after | Click to add a message item below the currently selected message. |

| Field Name | Action/Definition |
|------------------|---|
| Move up | Click to move the selected message item up one level in the list. |
| Move down | Click to move the selected message item down one level in the list. |
| Remove | Click to remove the selected message item. |

Item n Definition

| | |
|---------------------------|--|
| Item Type | Select Text String , Code Related Item , or Package Related Item from the drop-down list. Each selection reveals a unique set of options. |
| String Field | <p>Click  to activate the Text Entry Tool and create a text string message. This option is available when Item Type > Text String has been selected.</p> <p>Click Submit to save your text to the origin window text field, or click Cancel to return to origin window without transferring text.</p> |
| Code Related Items | <p>Select a code related item from those available in the drop-down list. This option is available when Item Type > Code Related Item has been selected. The Code Related Items can be associated to a specific programmed code or group label depending on the Code Combination selection.</p> <p>Selections Include:</p> <ul style="list-style-type: none"> • Barcode: Barcode data • Barcode Length: Number of characters in code • Read Bitmap: 32-bit mask indicating which scanner in the network has read the code (when character <1> is present in the related position) • Total Read Count: Indicates how many times the code has been read by all scanners present in the network during the same reading phase • Read Count (by device): Indicates the number of times the code has been read by one specific scanner present in the network during the reading phase (selectable among those present) • X Position: X coordinate for the code that was read • Y Position: Y coordinate for the code that was read • Z Position: Z coordinate for the code that was read • Code Identifier: Indicates type of code that was read • Code Direction: Indicates if the code has been read either from either the start character or the stop character • Code Distance: Indicates the distance to the code that was read • Decode Mode: Indicates if the code has been read using Linear or Reconstruction (ACR) reading mode |

| Field Name | Action/Definition |
|-----------------------------|---|
| | <ul style="list-style-type: none"> • Decode Scans Number: Indicates the minimum number of decoded scans referred to the single characters in a code when the device is reading in Reconstruction mode. This Item can be used as Code Quality Index • Average Code Position: Average position of the code in the scan line (Average of Minimum and Maximum Code Position) • Minimum Code Position: Minimum position of the code in the scan line (closest to the left side/connector side of the scanner) • Maximum Code Position: Maximum position of the code in the scan line (farthest from the left side/connector side of the scanner) • Ink Spread: Indicates the calculated Ink Spread value • Encoder Value: Indicates the encoder/tachometer pulse value from trigger to the code being read • Laser Number: If more than one laser is present in the working device, this item indicates the laser used to read the code • Reading Persistence: Indicates how many times the laser beam has crossed the complete code during the reading phase |
| Package Related Item | <p>Select a package related item from those available in the drop-down list. This option is available when Item Type > Package Related Item has been selected.</p> <p>Selections Include:</p> <ul style="list-style-type: none"> • Package Sequence Number: Indicates the sequential number assigned to the package. • Total Read Bitmap: Indicates the complete reading mask related to all codes read during the reading phase • Failure Bitmap: 32-bit mask indicating which devices in the network are in fault (when character <1> is present in the related position) • Total Read Count: Indicates the sum of all Code-related Total Reading Counts of each code read during the reading phase • Read Count (by device): Indicates the number of codes read during the reading phase by the device • Minimum Code Distance: Indicates the distance of the code closest to the device read during the reading phase • Maximum Code Distance: Indicates the distance of the code most distant from the scanner that has been read during the reading phase • Decode Mode (Master): Indicates the programmed Reading Mode, either Linear or Reconstruction • Number of Rejected Codes: Indicates the number of codes rejected during the internal analysis (unexpected code, multiple read, discarded by the programmed logical rule) |

| Field Name | Action/Definition |
|--------------------------------------|--|
| | <ul style="list-style-type: none"> • Package Length: Indicates the approximate length of the package • Start Trigger Encoder Value: Indicates the encoder/tachometer pulse value when the package first hits the trigger PS • End Trigger Encoder Value: Indicates the encoder/tachometer pulse value when the package exits the trigger PS • Transmit Encoder Value: Indicates the encoder/tachometer pulse value when the data transmit occurs • Current Trigger Count: Indicates the number of trigger cycles that have occurred • Working Hours (By Device): Indicates the total number of hours the device has been active • Total Good Reads: Indicates the total number of barcodes successfully read • Total No Reads: Indicates the total number of barcodes that were not read • Total Multi Reads: Indicates the number of times packages carried more codes than the scanner is programmed to read • Total Partial Reads: Indicates the total number of barcodes only partially read • Protocol Index: Indicates the programmed protocol index string data |
| Code/Group Selection | Select a Code/Group from those available in the drop-down list. This option is available when Item Type > Code Related Item has been selected. |
| Device Index | Select a device index number from the drop-down list. This option is available when Item Type > Code Related Item > Read Count (By Device) or Type > Package Related Items > Read Count (By Device)/Working Hours (By Device) has been selected. |
| Text String: Options | |
| Link to Code | Select Disabled, Previous Code, or Next Code from the drop-down list. <ul style="list-style-type: none"> • Disabled: A code will not be linked to this text string • Previous Code: The text string will be linked to the previous generated code • Next Code: The text string will be linked to the next generated code |
| Package Related Item: Options | |
| Item Alignment | Select None, Left, or Right from the drop-down list. |
| Item Alignment Length | Enter an Item Alignment Length in the field provided. |
| Item Alignment Filler | Click  to activate the Text Entry Tool and create filler text. Click Submit to save your text to the origin window text field, or click Cancel to return to origin window without transferring text. |
| Item Data Size | Select Variable or a number of digits to use from the drop-down list. |

| Field Name | Action/Definition |
|---|---|
| Item Data Format | Select Decimal (ASCII) , Hexadecimal (ASCII) , Bitmap (ASCII) , or Numeric (Binary) from the drop-down list. |
| Code Related Item: Options | |
| Code Cutting | Select None, Simple, or Pattern from the drop-down list. |
| Selections: | |
| <ul style="list-style-type: none"> • Simple: Allows cutting a programmable part of the code either at the beginning or at the end of the code. • Pattern: Allows cutting a part of the code according to a particular prefixed pattern. | |
| Number of Leading Chars to Cut | Enter the number of leading characters to cut from the barcode in the field provided (available when Simple is selected from the Code Cutting drop-down list). |
| Number of Trailing Chars to Cut | Enter the number of trailing characters to cut from the barcode in the field provided (available when Simple is selected from the Code Cutting drop-down list). |
| Pattern Delimiting Chars to Cut | Enter the pattern delimiting characters in the field provided (available when Pattern is selected from the Code Cutting drop-down list). |
| Pattern Mode | Select Keep Before, Keep After, or Keep Middle from the drop-down list (available when Pattern is selected from the Code Cutting drop-down list). |

Selections:

- **Keep Before:** Cuts the part of the code that starts with the pattern string (data before the string remains).
- **Keep After:** Cuts the part of the code that precedes and includes the pattern string (data after the string remains).
- **Keep Middle:** Cuts the part of the code before and after (including) the two pattern strings (data between the two strings remains)

Example:

Item 11 Definition

| | |
|----------------------|---------------------|
| Item Type | Code Related Item ▼ |
| Code Related Items | Bar Code ▼ |
| Code/Group Selection | Group 4 ▼ |

Options

| | |
|---------------------------------|---------------|
| Code Cutting | Pattern ▼ |
| Pattern Delimiting Chars to Cut | 123 |
| Pattern Mode | Keep Before ▼ |
| Item Alignment | Keep Before |
| Item Alignment Length | Keep After |
| Item Alignment Filler | Keep Middle |

| Field Name | Action/Definition |
|------------------------------|--|
| | <p>Referring to the window image above, if the read code is SDFR1235689123ASER the transmitted code (depending on the selected Pattern Mode) will be:</p> <ul style="list-style-type: none"> • Keep Before: SDFR • Keep After: 5689123ASER • Keep Middle: 5689 |
| Item Alignment Filler | Click  to activate the Text Entry Tool and create filler text. Click Submit to save your text to the origin window text field, or click Cancel to return to origin window without transferring text. |
| Item Data Size | Select Variable or a number of digits to use from the drop-down list. |
| Item Data Format | Select Decimal (ASCII) , Hexadecimal (ASCII) , Bitmap (ASCII) , or Numeric (Binary) from the drop-down list. |

- When you have finished making changes, click **Update All** to save all pending changes, click **Reset All** to revert to all previously saved values, and click **Reset Page** to revert to previous saved values on the current page.

Modify Settings | Global Settings | Messaging | Statistics

Use the **Statistics** window to select the desired statistical counters, making up the statistics field, and relative statistics field separator string to be sent to the system by the Stand Alone or Master scanner.

To edit the **Statistics** settings:

1. In the tree menu under **Modify Settings**, navigate to **Global Settings | Messaging | Statistics**. The Statistics window opens.

2. Enter the appropriate information in the form as described below:

| Field Name | Action/Definition |
|---------------|---|
| Enable | Select the check box to reveal and edit statistic message options. The selections correspond to the message as shown below: |

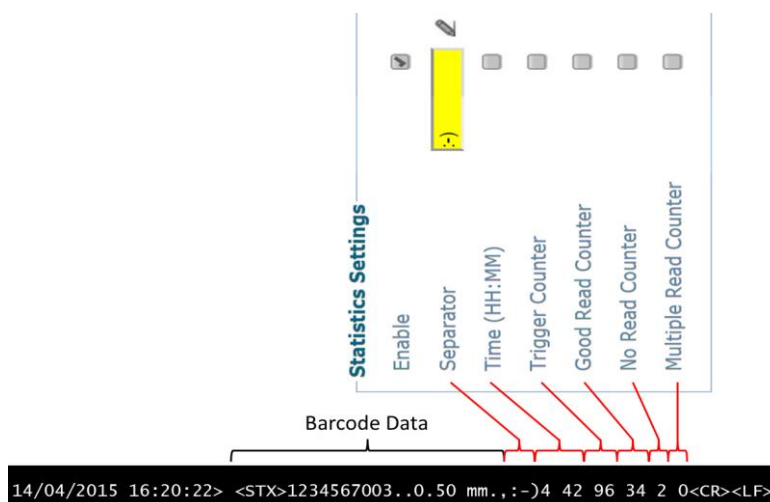

| | |
|------------------|--|
| Separator | Click  to activate the Text Entry Tool and create a Separator in the text field provided. Separator strings (up to 32 bytes) can be created and will be inserted between the last item in the <i>Data</i> field and the first item in the <i>Statistics</i> field. |
|------------------|--|



NOTE: A fixed <space> character separates all items within the Statistics field.

Click **Submit** to save your text to the origin window text field, or click **Cancel** to return to origin window without transferring text.

| Field Name | Action/Definition |
|------------------------------|---|
| Time | Select the check box to include the time counter in the statistical message, reporting the time elapsed in hours and minutes (H MM) from the last hardware reset. |
| Trigger Counter | Select the check box to reports the total number of trigger sessions (reading phases) from the last hardware reset. |
| Good Read Counter | Select the check box to report the total number of good reads from the last hardware reset. |
| No Read Counter | Select the check box to report the total number of no reads from the last hardware reset. |
| Multiple Read Counter | Select the check box to report the total number of multiple reads from the last hardware reset. |

3. When you have finished making changes, click **Update All** to save all pending changes, click **Reset All** to revert to all previously saved values, and click **Reset Page** to revert to previous saved values on the current page.

Modify Settings | Global Settings | Messaging | Protocol Index

Use the **Protocol Index** window to configure Protocol Index parameters. Protocol Index allows the Host to transmit a string that it has associated to a pack contained within the tracking area.

It is possible to manage several different Protocol Index messages (one per available communication interface), within the same reading phase (for the same pack). If more than one Index message is received on the same communication interface, only the last one will be accepted.

These strings will be received by the DS8110/DX8210 Master or SC5000 and included within its output message according to the following order:

1. Built-In Ethernet User Socket 1
2. Built-In Ethernet User Socket 2
3. Built-In Ethernet User Socket 3
4. Auxiliary Serial Port
5. Main Serial Port

The general output format is: <Header>Index1<Data Packet Separator>...IndexN<Data Packet Separator>Standard Message<Terminator>

The Index field has the following format: <Index Header>Index Message<Index Terminator>



NOTE: This parameter is only available for scanners configured as **Standalone** or as **Master** when working in **On Line** or **PackTrack** operating modes.

In **On Line** mode, the Protocol Index must arrive during the active reading phase otherwise it will be discarded.

- If the Distance from Protocol Index to Trigger Line parameter = 0, the Protocol Index must arrive during the active reading phase otherwise it will be discarded.

In **PackTrack** mode:

- If the Distance from Protocol Index to Trigger Line parameter is not = 0, the Protocol Index will arrive at the specified distance.

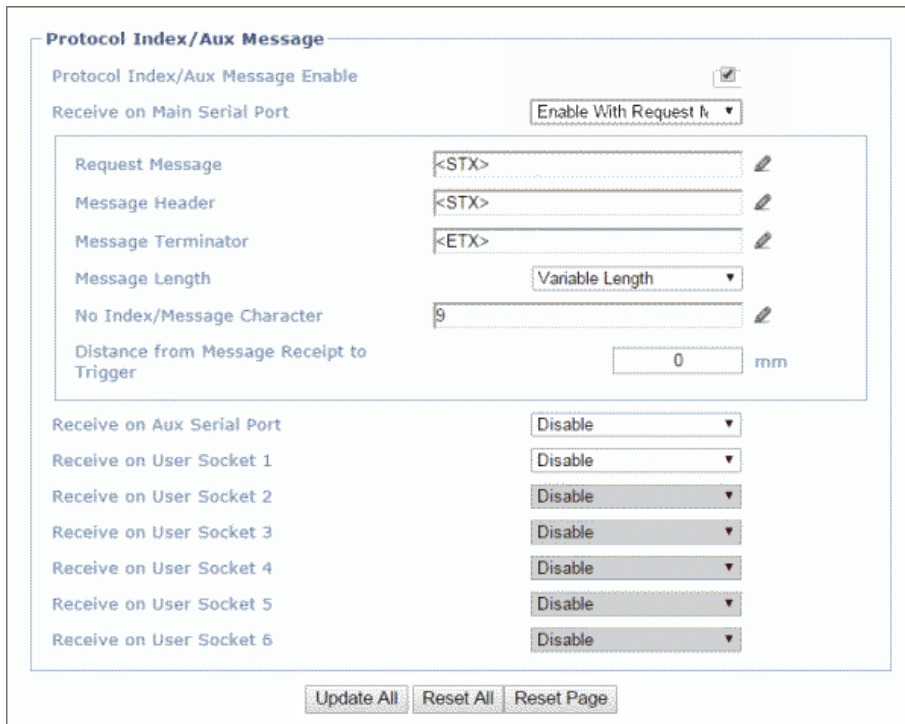

To edit the Protocol Index settings:

1. In the tree menu under Modify Settings, navigate to Global Settings | Messaging | Protocol Index. The Protocol Index window opens.



2. Enter the appropriate information in the form as described below:

| Field Name | Action/Definition |
|---|---|
| Protocol Index/Aux Message Enable | Select the check box to reveal and edit Protocol Index/Aux Message options. |
| Receive on (communication channel) | Select Disable , Enable without Request Message , or Enable with Request Message from the drop-down list. <ul style="list-style-type: none"> • Disable: The selected communication channel is not used for Protocol Index string communication. • Enable without Request Message: The Host sends the Protocol Index string autonomously on the selected communication channel. • Enable with Request Message: The Host waits for the Protocol Index Request Message sent by the scanner, when the trigger detects the presence of a pack, before transmitting the Protocol Index string associated to the pack itself on the selected communication channel. |
| Request Message | Click to activate the Text Entry Tool and create a Request Message (up to 128 bytes) to be defined and transmitted. Use characters from NUL (00H) to ~ (7EH). Click Submit to save your changes, or click Cancel to return to previous window. |
| Message Header | Click to activate the Text Entry Tool and create a Header (up to 128 bytes) to be defined and transmitted as a block preceding the Protocol Index string sent by the Host. Use characters from NUL (00H) to ~ (7EH). Click Submit to save your text to the origin window text field, or click Cancel to return to origin window without transferring text. |

| Field Name | Action/Definition |
|---|---|
| Message Terminator | <p>Click  to activate the Text Entry Tool and create a Terminator to be defined and transmitted as a block following the Protocol Index string sent by the Host. Use characters from NUL (00H) to ~ (7EH).</p> <p>Click Submit to save your text to the origin window text field, or click Cancel to return to origin window without transferring text.</p> |
| Message Length | <p>Select Length in Message, Variable Length, or a length of 3 through 12 from the drop-down list.</p> <ul style="list-style-type: none"> • Length in Message: The first byte of the scanner output message indicates the length of the Protocol Index string sent by the Host. • Variable Length: The length of the Protocol Index string sent by the Host is variable. • 3...12: The Protocol Index string has a fixed length from 3 to 12 characters. |
| No Index/Message Character | <p>Click  to activate the Text Entry Tool and create a No Index Char. Click Submit to save your text to the origin window text field, or click Cancel to return to origin window without transferring text.</p> |
| Distance from Message Receipt to Trigger | <p>Enter the distance of travel between when a package hits the trigger (presence sensor) to when it should receive an expected message from, for example, a scale or other device.</p> <p>When the Receive on Main Serial Port parameter of the selected interface port is set to Enable without Request Message, this parameter specifies the distance from the Trigger Line (i.e. Presence Sensor) to the expected receiving point of the Protocol Index/Aux Message. If set to 0 the Protocol Index/Aux Message must arrive during the active reading phase otherwise it will be discarded.</p> |

3. When you have finished making changes, click **Update All** to save all pending changes, click **Reset All** to revert to all previously saved values, and click **Reset Page** to revert to previous saved values on the current page.

Modify Settings | Global Settings | Messaging | Pass-Thru

Use the **Pass-Thru** window to pass a message received on ANY port (serial or user socket connection) to any other port(s).

Applications can also be implemented to connect a device such as a hand-held reader to any serial or network port for additional manual code reading capability.

When using Pass-Thru mode, follow these programming notes:

- When using serial ports - Program receiving port same way regarding baud rate, data bits, stop bits and parity to the device sending the data.
- The Termination string must be configured in the same way as the message terminator on the device sending the data. The terminator will be forwarded with the message.

To edit the Pass-Thru settings:

1. In the tree menu under **Modify Settings**, navigate to **Global Settings | Messaging | Pass-Thru**. The Pass-Thru window opens.

Pass-Thru Settings

Source - Main Serial Port

String Length: 128

Termination String: <CR><LF>

Destination

| | | | | | |
|-----------------|--------------------------|---------------|--------------------------|---------------|--------------------------|
| Aux Serial Port | <input type="checkbox"/> | User Socket 1 | <input type="checkbox"/> | User Socket 2 | <input type="checkbox"/> |
| User Socket 3 | <input type="checkbox"/> | User Socket 4 | <input type="checkbox"/> | User Socket 5 | <input type="checkbox"/> |
| User Socket 6 | <input type="checkbox"/> | | | | |

Source - Aux Serial Port

Source - User Socket 1

Source - User Socket 2

Source - User Socket 3

Source - User Socket 4

Source - User Socket 5

Source - User Socket 6

Update All Reset All Reset Page

2. Enter the appropriate information in the form as described below:

| Field Name | Action/Definition |
|---------------------------|---|
| Source | Select the check box(es) following the Main Serial Port , Aux Serial Port , or numbered User Socket you wish to modify. |
| String Length | Enter the maximum length of the expected string to be received. If the string is longer than the one expected, it will be discarded. |
| Termination String | Click  to activate the Text Entry Tool to define the characters terminating the expected string. Click Submit to save your text to the origin window text field, or click Cancel to return to origin window without transferring text. |
| Destination | Select the check box next to the destination(s) to be used for the Pass-Thru. |

3. When you have finished making changes, click **Update All** to save all pending changes, click **Reset All** to revert to all previously saved values, and click **Reset Page** to revert to previous saved values on the current page.

Modify Settings | Global Settings | Messaging | Diagnostics Messages

Use the **Diagnostic Message** window to select the parameters managing diagnostic message transmission by the **Stand Alone** or **Master** scanner.

To edit the **Diagnostic Message** settings:

1. In the tree menu under **Modify Settings**, navigate to **Global Settings | Messaging | Diagnostic Message**. The Diagnostic Message window opens.

2. Enter the appropriate information in the form as described below:

| Field Name | Action/Definition |
|----------------------|---|
| Transmit Mode | Select On Timeout or With Code from the drop-down list. The diagnostic message can be transmitted to the system by the Stand Alone or Master barcode scanner either asynchronously (at programmed intervals), or synchronously with the code. |
| Tx Refresh | Select a TX Refresh rate in seconds or minutes from the drop-down list to define the time interval in which the diagnostic messages will be transmitted if Tx Mode is asynchronous (On Timeout). |

| Field Name | Action/Definition |
|-------------------------|--|
| Message Position | Select Append to Code or Replace Code from the drop-down list. If Transmit Mode is synchronous (With Code), the diagnostic messages will be transmitted on the same interface used for code transmission. This selection determines if the messages will replace the code or be appended to it. |

Error Messages

Transmit Mode With Code ▼

Message Position Append to Code ▼

Message Format

Header String Click  to activate the **Text Entry Tool** to define the header string (up to 128 characters) as a block preceding the diagnostic message. Use characters from NUL (00H) to ~ (7EH).

Click **Submit** to save your text to the origin window text field, or click **Cancel** to return to origin window without transferring text.

Terminator String Click  to activate the **Text Entry Tool** to define the terminator string (up to 128 characters) as a block following the diagnostic message. Use characters from NUL (00H) to ~ (7EH).

Click **Submit** to save your text to the origin window text field, or click **Cancel** to return to origin window without transferring text.

Error Message Type Select **Numeric** or **Global String** from the drop-down list to define how the message will be sent.

Global String (max. 32 chars) Click  to activate the **Text Entry Tool** to define the **Global String** message (up to 32 bytes) that will be sent as a diagnostic message for any detected diagnostic error.

Click **Submit** to save your text to the origin window text field, or click **Cancel** to return to origin window without transferring text.

Destination Select the check box next to the destination(s) to be used for the diagnostic messages.

PackTrack Messages

PackTrack Debug Message Enable Select the checkbox to enable debug messages for PackTrack. If selected, this parameter allows transmitting messages concerning the system functioning.

PackTrack Debug Message Port Select **Main Serial**, **Aux Serial**, or **Socket n** from the drop-down list. The debug message will be transmitted through the selected port.

PackTrack Debug Message Digital Input Select **None**, **Trigger (Input 1)**, **Aux (Input 3)**, or **I/O 4 (Input 4)** from the drop-down list. This selection defines which digital input will be used to trigger debug message transmission.

- When you have finished making changes, click **Update All** to save all pending changes, click **Reset All** to revert to all previously saved values, and click **Reset Page** to revert to previous saved values on the current page.

4.5.8 Modify Settings | Global Settings | Digital I/O

Use the **Digital I/O** window to configure the digital inputs and outputs for your barcode scanning system.

To edit the **Digital I/O** settings:

1. In the tree menu under **Modify Settings**, navigate to **Global Settings | Digital I/O**. The Digital I/O window opens.

2. Enter the appropriate information in the form as described below:

| Field Name | Action/Definition |
|----------------------------|-------------------|
| Digital Input Lines | |

Trigger (Input 1) Active Level Select **Active Closed** or **Active Open** from the drop-down list.

- **Active Closed:** Input 1 is active when current flows through (IN1) EXT_TRIG pins.
- **Active Open:** Input 1 is active when there is no current flowing through (IN1) EXT_TRIG pins.



NOTE: This parameter setting is not valid, if the input has already been defined in **On Line** or **PackTrack Operating Modes**.

| Field Name | Action/Definition |
|----------------------|--|
| Aux (Input 3) | Select Active Closed or Active Open from the drop-down list. |
| Active Level | <ul style="list-style-type: none"> • Active Closed: Input 3 is active when current flows through IN3 pins. • Active Open: Input 3 is active when there is no current flowing through IN3 pins. |



NOTE: This parameter setting is not valid, if the input has already been defined in **On Line** or **PackTrack Operating Modes**.

Digital Output Lines

| | |
|--|--|
| Select Digital Output Number to View/Modify | Select the number of the output you will view or modify from the drop-down list. |
|--|--|

Digital Output *n*

| | |
|------------------------------------|--|
| Digital Output <i>n</i> Use | Select Local , EthernetIP , or Profibus/Profinet from the drop-down list. This parameter selects the source that drives the digital output. Local output is driven by the device application program. EthernetIP is driven by the EtherNet/IP Host and Profibus/Profinet is driven by the relative Fieldbus Host. |
|------------------------------------|--|

| | |
|---|--|
| Digital Output <i>n</i> Line State | Select Normally Open or Normally Closed from the drop-down list. |
|---|--|

Each output can be represented with an **NPN** transistor; this transistor acts like a switch: so, when the transistor is **OFF**, it acts like an **OPEN** switch. On the contrary, when the transistor is **ON**, it acts like a **CLOSED** switch.

- **Normally Open:** The idle state of the output line is open, that is, the **NPN** transistor is **OFF** (like an open switch). When the output is activated, the transistor goes **ON** (like a closed switch).
- **Normally Closed:** The idle state of the output line is closed, that is, the **NPN** transistor is **ON** (like a closed switch). When the output is activated, the transistor goes **OFF** (like an open switch).

Activation

| | |
|---------------------------------|---|
| Primary Activation Event | Select a Primary Activation Event from the drop-down list (see below). <ul style="list-style-type: none"> • None: The output is always in line state. • Complete Read: The event occurs, if all selected codes are read. • Partial Read: The event occurs, if less than the selected codes are read. • No Read: The event occurs, if no code is read. • Trigger On: The event occurs, when a start event takes place starting the reading phase. • Trigger Off: The event occurs, when a stop event takes place ending the reading phase. • Multiple Read: The event occurs, if a code is read more than once consecutively. • Right/Match: The event occurs, if a code is successfully decoded and matches the Match Code (Verifier Code). • Wrong/No Match: The event occurs, if a code is successfully decoded but does not match the Match Code (Verifier Code). |
|---------------------------------|---|

| Field Name | Action/Definition |
|-----------------------------------|--|
| Secondary Activation Event | <p>Select a Secondary (Alternate) Activation Event from the drop-down list (see below).</p> <ul style="list-style-type: none"> • None: The output is always in line state. • Complete Read: The event occurs, if all selected codes are read. • Partial Read: The event occurs, if less than the selected codes are read. • No Read: The event occurs, if no code is read. • Trigger On: The event occurs, when a start event takes place starting the reading phase. • Trigger Off: The event occurs, when a stop event takes place ending the reading phase. • Multiple Read: The event occurs, if a code is read more than once consecutively. • Right/Match: The event occurs, if a code is successfully decoded and matches the Match Code (Verifier Code). • Wrong/No Match: The event occurs, if a code is successfully decoded but does not match the Match Code (Verifier Code). |
| Activate On Error | <p>Select Disable or Enable from the drop-down list. If this parameter is enabled, the output will activate when a diagnostic error message is sent.</p> |



NOTE: When using this parameter, all other activation events should be set to **None**.

Deactivation

| | |
|-------------------------------------|--|
| Primary Deactivation Event | <p>Select a Primary Deactivation Event from the drop-down list (see below).</p> <ul style="list-style-type: none"> • None: A deactivation event is NOT defined. • Timeout: Indicates the maximum duration of the output pulse. When selected, the Deactivation Timeout text field is revealed. • Trigger On: The event occurs, when a start event takes place starting the reading phase. • Trigger Off: The event occurs, when a stop event takes place terminating the reading phase. |
| Secondary Deactivation Event | <p>Select a Secondary (Alternate) Deactivation Event from the drop-down list (see below).</p> <ul style="list-style-type: none"> • None: A secondary deactivation event is NOT defined. • Trigger On: The event occurs, when a start event takes place starting the reading phase. • Trigger Off: The event occurs, when a stop event takes place terminating the reading phase. |
| Deactivate On Clear Error | <p>Select Disable or Enable from the drop-down list. If this parameter is enabled, the output will deactivate when the error is no longer present.</p> |
| Deactivation Timeout | <p>Enter the maximum duration of the output pulse in the text field provided. Input a value from 40 to 15000 milliseconds.</p> |

- When you have finished making changes, click **Update All** to save all pending changes, click **Reset All** to revert to all previously saved values, and click **Reset Page** to revert to previous saved values on the current page.

4.5.9 Modify Settings | Global Settings | Diagnostics

Use the **Diagnostics** window to configure error reporting for your barcode scanning system.

To edit the **Diagnostics** settings:

1. In the tree menu under **Modify Settings**, navigate to **Global Settings | Diagnostics**. The Diagnostics window opens.

2. Enter the appropriate information in the form as described below:

| Field Name | Action/Definition |
|---|---|
| Sampling Time | Select a Sampling Time in seconds or minutes from the drop-down list. This selection indicates the time lapse between system diagnostic queries. |
| Report Slave Scanner Diagnostics | Select the check box to report diagnostic information from the slave scanners in the system. |
| Errors To Report | Select the check box next to each error type the system should report. |
| Presence Sensor Failure | Select the check box to report presence sensor failure errors. |
| Presence Sensor Stuck Timeout | Select a Disable or a time interval in seconds or minutes from the drop-down list. |
| No Phase Timeout | Select Disable or a time interval in seconds or minutes from the drop-down list. If a time interval is selected, a stuck sensor will report an error after the selected interval. |
| Protocol Index Alarms | Select the check box to enable protocol index alarm messages. |

| Field Name | Action/Definition |
|--|--|
| Maximum Consecutive Lost Protocol Indexes | Enter the number of consecutive lost protocol indexes allowed before an error is reported. |
| Maximum % Of Lost Protocol Indexes | Enter the maximum percentage of lost protocol indexes allowed before an error is reported. |
| PTP Time Synchronization Failure | Select the check box to report PTP (Precision Time Protocol) Time Synchronization Errors. |
| Encoder Failure | Select the check box to report encoder (tachometer) errors. |
| Encoder Timeout | Select Disable or a time interval in seconds or minutes from the drop-down list. If a time interval is selected, a stuck encoder will report an error after the selected interval. |

- When you have finished making changes, click **Update All** to save all pending changes, click **Reset All** to revert to all previously saved values, and click **Reset Page** to revert to previous saved values on the current page.

4.5.10 Modify Settings | Global Settings | Energy Saving

Use the **Energy Saving** window to activating/deactivate energy saving feature. In particular, it allows turning network scanner motors and lasers on or off according to specific conditions. It is suggested to use this parameter for example when the conveyor is stopped for a lengthy period.

To view and edit the Energy Saving settings:

1. In the tree menu under **Modify Settings**, navigate to **Global Settings | Energy Saving**. The **Energy Saving** window opens.

2. Enter the appropriate information in the form as described below:











| Field Name | Action/Definition |
|------------------------------------|---|
| Energy Saving Configuration | Select the check box to reveal Energy Saving Configuration options. |
| Use Encoder For | Select None, Deactivation, Activation, or Activation and Deactivation from the drop-down list. This parameter allows defining the function to be performed by an Encoder: <ul style="list-style-type: none"> • None: No function is performed by the digital input. • Deactivation: The digital input is used to deactivate the Energy Saving. Thus, the motor and laser of all network scanners will be turned on. |











| Field Name | Action/Definition |
|-------------------------------------|---|
| | <ul style="list-style-type: none"> • Activation: The digital input is used to activate the Energy Saving. Thus, the motor and laser of all network scanners will be turned off. • Activation and Deactivation: The digital input is used to both activate and deactivate the Energy Saving. Thus, the motor and laser of all network scanners will be turned on/off. |
| Activation Encoder Timeout | Select a minute value from the drop-down list. This parameter is available only when the encoder is used for the Energy Saving activation. If the encoder is stopped for more than the programmed timeout, the Energy Saving will be activated. |
| Deactivation Encoder Timeout | Select a second or minute value from the drop-down list. This parameter is available only when the encoder is used for the Energy Saving deactivation. If the encoder runs for at least the programmed timeout, the Energy Saving will be deactivated. |
| Use Digital Input For | Select None , Deactivation , Activation , or Activation and Deactivation from the drop-down list. This parameter allows defining the function to be performed by a digital input: <ul style="list-style-type: none"> • None: No function is performed by the digital input. • Deactivation: The digital input is used to deactivate the Energy Saving. Thus, the motor and laser of all network scanners will be turned on. • Activation: The digital input is used to activate the Energy Saving. Thus, the motor and laser of all network scanners will be turned off. • Activation and Deactivation: The digital input is used to both activate and deactivate the Energy Saving. Thus, the motor and laser of all network scanners will be turned on/off. |
| Select Digital Input | Select a digital input from the drop-down list. This parameter defines the digital input to be used for activating/deactivating the Energy Saving. |
| Select Input Type | Select Edge or Level from the drop-down list. |
| Use Main Serial Port For | Select None , Deactivation , Activation , or Activation and Deactivation from the drop-down list. This parameter allows defining the function to be performed by Main Serial Port: <ul style="list-style-type: none"> • None: No function is performed by the digital input. • Deactivation: The digital input is used to deactivate the Energy Saving. Thus, the motor and laser of all network scanners will be turned on. • Activation: The digital input is used to activate the Energy Saving. Thus, the motor and laser of all network scanners will be turned off. • Activation and Deactivation: The digital input is used to both activate and deactivate the Energy Saving. Thus, the motor and laser of all network scanners will be turned on/off |



Header

NOTE: This parameter is available only when a communication channel has been selected to perform a specific function.

Click  to activate the **Text Entry Tool** and create a **Header** (up to 128 bytes) to define a header (1 byte) and transmit it as a block preceding the activation/deactivation string sent to a Master or Stand Alone scanner. Use characters from NUL (00H) to ~ (7EH). Click **Submit** to save your text to the origin window text field, or click **Cancel** to return to origin window without transferring text.

| Field Name | Action/Definition |
|--------------------------------|---|
| Terminator |  <p>NOTE: This parameter is available only when a communication channel has been selected to perform a specific function.</p> <p>Click  to activate the Text Entry Tool and create a Terminator to define a terminator (1 byte) and transmit it as a block following the activation/deactivation string sent to the Master or Stand Alone scanner. Use characters from NUL (00H) to ~ (7EH). Click Submit to save your text to the origin window text field, or click Cancel to return to origin window without transferring text.</p> |
| Activation String |  <p>NOTE: This parameter is available only when a communication channel has been selected to perform the Activation or Activation & Deactivation function.</p> <p>Click  to activate the Text Entry Tool and create a string that defines the characters to be transmitted within the output message to activate the Energy Saving. Click Submit to save your text to the origin window text field, or click Cancel to return to origin window without transferring text.</p> |
| Deactivation String |  <p>NOTE: This parameter is available only when a communication channel has been selected to perform the Deactivation or Activation & Deactivation function.</p> <p>Click  to activate the Text Entry Tool and create a character string to be transmitted within the output message to deactivate the Energy Saving. Click Submit to save your text to the origin window text field, or click Cancel to return to origin window without transferring text.</p> |
| Use Aux Serial Port For | <p>Select None, Deactivation, Activation, or Activation and Deactivation from the drop-down list. This parameter allows defining the function to be performed by the Aux Serial Port:</p> <ul style="list-style-type: none"> • None: No function is performed by the digital input. • Deactivation: The digital input is used to deactivate the Energy Saving. Thus, the motor and laser of all network scanners will be turned on. • Activation: The digital input is used to activate the Energy Saving. Thus, the motor and laser of all network scanners will be turned off. • Activation and Deactivation: The digital input is used to both activate and deactivate the Energy Saving. Thus, the motor and laser of all network scanners will be turned on/off. |
| Header |  <p>NOTE: This parameter is available only when a communication channel has been selected to perform a specific function.</p> <p>Click  to activate the Text Entry Tool and create a Header (up to 128 bytes) to define a header (1 byte) and transmit it as a block preceding the activation/deactivation string sent to a Master or Stand Alone scanner. Use characters from NUL (00H) to ~ (7EH). Click Submit to save your text to the origin window text field, or click Cancel to return to origin window without transferring text.</p> |
| Terminator |  <p>NOTE: This parameter is available only when a communication channel has been selected to perform a specific function.</p> <p>Click  to activate the Text Entry Tool and create a Terminator to define a terminator (1 byte) and transmit it as a block following the activation/deactivation string sent to the Master or Stand Alone scanner. Use characters from NUL (00H) to ~ (7EH). Click Submit to save your text to the origin window text field, or click Cancel to return to origin window without transferring text.</p> |

| Field Name | Action/Definition |
|----------------------------|--|
| Activation String |  <p>NOTE: This parameter is available only when a communication channel has been selected to perform the Activation or Activation and Deactivation function.</p> <p>Click  to activate the Text Entry Tool and create a string that defines the characters to be transmitted within the output message to activate the Energy Saving. Click Submit to save your text to the origin window text field, or click Cancel to return to origin window without transferring text.</p> |
| Deactivation String |  <p>NOTE: This parameter is available only when a communication channel has been selected to perform the Deactivation or Activation and Deactivation function.</p> <p>Click  to activate the Text Entry Tool and create a character string to be transmitted within the output message to deactivate the Energy Saving. Click Submit to save your text to the origin window text field, or click Cancel to return to origin window without transferring text.</p> |
| User Socket n For | <p>Select None, Deactivation, Activation, or Activation and Deactivation from the drop-down list. This parameter allows defining the function to be performed by a numbered Socket:</p> <ul style="list-style-type: none"> • None: No function is performed by the digital input. • Deactivation: The digital input is used to deactivate the Energy Saving. Thus, the motor and laser of all network scanners will be turned on. • Activation: The digital input is used to activate the Energy Saving. Thus, the motor and laser of all network scanners will be turned off. • Activation and Deactivation: The digital input is used to both activate and deactivate the Energy Saving. Thus, the motor and laser of all network scanners will be turned on/off. |
| Header |  <p>NOTE: This parameter is available only when a communication channel has been selected to perform a specific function.</p> <p>Click  to activate the Text Entry Tool and create a Header (up to 128 bytes) to define a header (1 byte) and transmit it as a block preceding the activation/deactivation string sent to a Master or Stand Alone scanner. Use characters from NUL (00H) to ~ (7EH). Click Submit to save your text to the origin window text field, or click Cancel to return to origin window without transferring text.</p> |
| Terminator |  <p>NOTE: This parameter is available only when a communication channel has been selected to perform a specific function.</p> <p>Click  to activate the Text Entry Tool and create a Terminator to define a terminator (1 byte) and transmit it as a block following the activation/deactivation string sent to the Master or Stand Alone scanner. Use characters from NUL (00H) to ~ (7EH). Click Submit to save your text to the origin window text field, or click Cancel to return to origin window without transferring text.</p> |
| Activation String |  <p>NOTE: This parameter is available only when a communication channel has been selected to perform the Activation or Activation and Deactivation function.</p> <p>Click  to activate the Text Entry Tool and create a string that defines the characters to be transmitted within the output message to activate the Energy Saving. Click Submit to save your text to the origin window text field, or click Cancel to return to origin window without transferring text.</p> |

| Field Name | Action/Definition |
|----------------------------|--|
| Deactivation String |  NOTE: This parameter is available only when a communication channel has been selected to perform the Deactivation or Activation and Deactivation function. Click  to activate the Text Entry Tool and create a character string to be transmitted within the output message to deactivate the Energy Saving. Click Submit to save your text to the origin window text field, or click Cancel to return to origin window without transferring text. |

- When you have finished making changes, click **Update All** to save all pending changes, click **Reset All** to revert to all previously saved values, and click **Reset Page** to revert to previous saved values on the current page.

4.5.11 Modify Settings | Global Settings | HMI Settings (Human-Machine Interface)

Use the **HMI Settings** window to configure some aspects of the scanner LEDs and X-Press interface.

To view and edit the HMI Settings:

1. In the tree menu under **Modify Settings**, navigate to **Global Settings | HMI Settings**. The HMI Settings window opens.

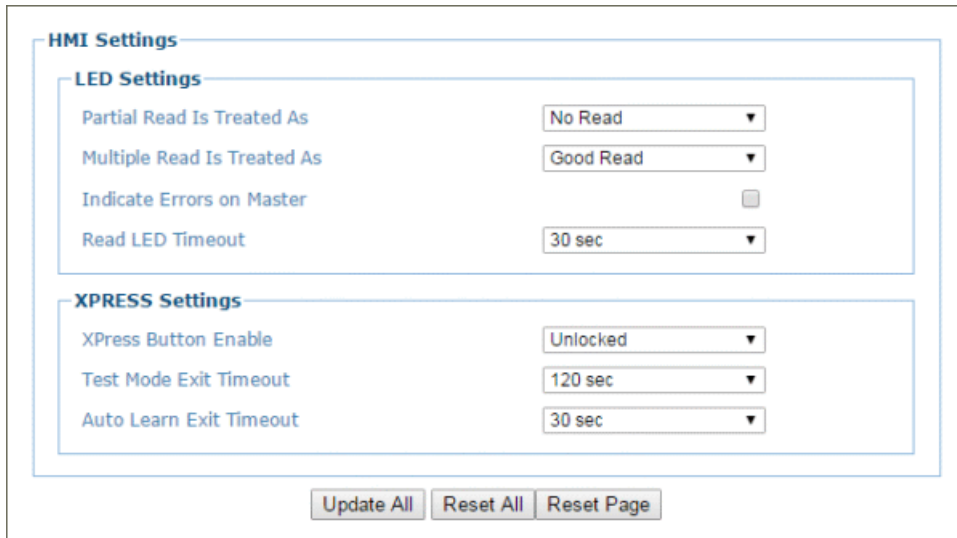

2. Enter the appropriate information in the form as described below:

| Field Name | Action/Definition |
|------------------------------------|--|
| LED Settings | |
| Partial Read Is Treated As | Select No Read or Good Read from the drop-down list. |
| Multiple Read Is Treated As | Select No Read or Good Read from the drop-down list. |
| Indicate Errors on Master | Select the check box to indicate errors from all Slave scanners also on the Master scanner's GOOD LED as described in the Scanner Reference Manual – LED Diagnostic Indication. See also Modify Settings Global Settings Diagnostics . |
| Read LED Timeout | Select Disable or a second value from the drop-down list. |
| XPRESS Settings | |
| XPress Button Enable | Select Unlocked, Partially Locked, or Locked from the drop-down list. <ul style="list-style-type: none"> • Unlocked: When selected, the XPress button is active • Locked: When selected, the XPress button is inactive |

Test Mode Exit Timeout Select **Disable** or a second value from the drop-down list. This indicates how long the scanner will stay in **Test** mode.

Auto Learn Exit Timeout Select **Disable** or a second value from the drop-down list. This indicates how long the scanner will stay in **Learn** mode.

3. When you have finished making changes, click **Update All** to save all pending changes, click **Reset All** to revert to all previously saved values, and click **Reset Page** to revert to previous saved values on the current page.

4.6 DEVICE SETTINGS

Use the **Device Settings Menu Tree** selections during initial mounting and setup to view device information and configure your **DS8110/DX8210 barcode scanner(s)**. If multiple scanners are used in a tunnel or array, each named scanner will be listed under Device Settings with the sub-menus **Device Info**, **Mounting**, and **Options**. If necessary, you can later make modifications to the configuration using the same menu selections, including:

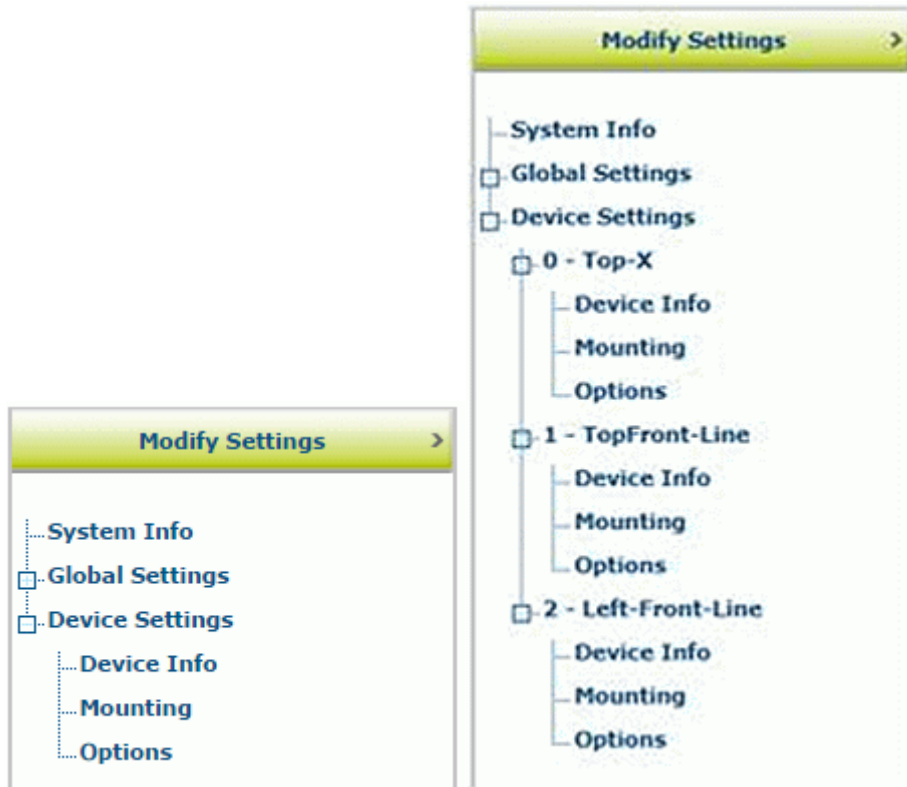

Single Scanner Menu Trees

Tunnel/Array Menu Tree

4.6.1 Device Settings | Device Name | Device Info

Use the **Device Info** window to information about each device in the system including description, serial number, and address.

To view the **Device Info** window:

1. In the tree menu under **Modify Settings**, navigate to **Device Settings | Device Name (if applicable) | Device Info**. The **Device Info** window opens.



NOTE: If more than one device is included in the scanning system, the device name will be listed in the menu tree after the Device Settings level.

Device Information

| | |
|-----------------------|---------------|
| Description | Master |
| Device Address | 0 |
| Serial Number | C14C03507 |
| MAC Address | 0007BE00EF8A |
| Model Name | DS8110-Custom |
| Model Number | 19 |
| Hardware Release | 65535 |
| Number Legs | 1 |
| Number Lasers | 2 |
| Number Facets | 7 |
| Scan Rate (scans/sec) | 1000 ▼ |

Software Versions

| | |
|------------------|---------------------------|
| Software Version | ARM_release_v0_8_5_5 |
| DSP Version | Decoder_release_v1_8_14_1 |
| FPGA Version | XLC_v8_28_0_0 |

2. View the following scanner information:

| Field Name | Definition |
|-----------------------|---|
| Description | Displays the scanner description entered in the System Info window. |
| Device Address | Displays the system address. |
| Serial Number | Displays the serial number sent by the device. |
| MAC Address | Displays the MAC (media access control) address of the device. |
| Model Name | Displays the Model name sent by the device. |

| Field Name | Definition |
|------------------------------|---|
| Model Number | Displays the Model number sent by the device. |
| Hardware Release | Displays the hardware release number of the device. |
| Number Legs | Displays the number of laser legs (beams) produced by the device. Each DS8110 (Line) scanner has 1 leg, while each DX8210 (X) scanner has 2 legs. |
| Number Lasers | Displays the number of lasers used by the scanner. |
| Number Facets | Displays the number of facets in the mirror wheel. |
| Scan Rate (scans/sec) | Displays the scans/per second achieved by the scanner. |
| Software Versions | |
| Software Version | Displays the currently installed version of the ARM (anonymizing relay monitor) software. |
| DSP Version | Displays the currently installed version of the decoder software. |
| FPGA Version | Displays the currently installed version of the field-programmable gate array software. |

4.6.2 Device Settings | Device Name | Mounting

Use the **Mounting** window to configure some aspects of the scanner LEDs and X-Press interface.

To view and edit the Mounting settings:

1. In the tree menu under **Modify Settings**, navigate to **Device Settings | Device Name (if applicable) | Mounting**. The Mounting window opens.



NOTE: If more than one device is included in the scanning system, the device name will be listed in the menu tree after the Device Settings level.

2. Enter the appropriate information in the form as described below:

| Field Name | Definition |
|---------------------------|--|
| Leg N | Select a laser leg for calibration from the drop-down list. |
| Calibration Method | Select PackTrack Calibration or Use Built-in Calibration from the drop-down list. If PackTrack Calibration is selected, use the wizard to automatically enter most of the data. If Use Built-in Calibration is selected, you can use it to quickly calibrate a top mount DX8210. |



NOTE: **Use Built-in Calibration**, is the only available with the DX8210.

| Field Name | Definition |
|------------------------------|------------|
| PackTrack Calibration | |

PackTrack Calibration Wizard Click **Launch Wizard** to open the **PackTrack Calibration Wizard**. See section 5.7 **PackTrack** for the complete procedure for using the wizard to set up your barcode scanner.

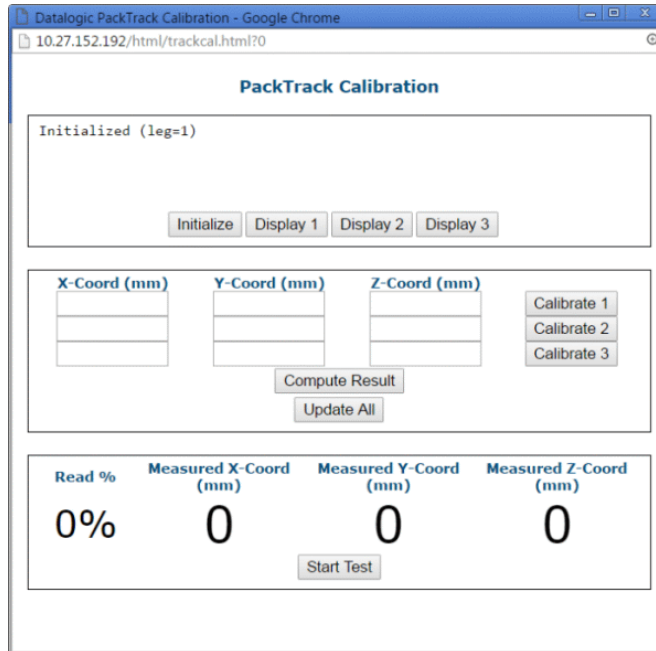



PackTrack Calibration Coefficients **Y Adjustment** Enter the scanner adjustment from **Y** axis in millimeters in the field provided. This is used to make fine adjustments to the tested calibration (see section 4.5.7).

Calibration Item 1-9 These non-editable fields display the PackTrack calculations.

| Use Built-in Calibration | |
|---------------------------------|--|
|---------------------------------|--|

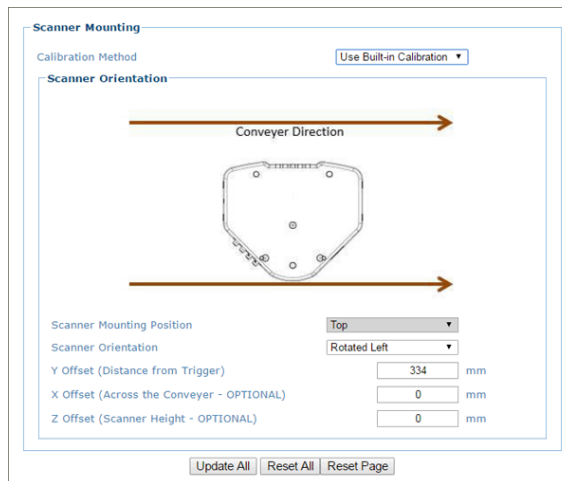
Built-in Calibration If **Use Built-in Calibration** is selected from the **Calibration Method** drop-down list. The **Scanner Orientation** window appears. See section 5.6 **Alternate Built-In Calibration for Top Mount** for the complete procedure for setting up your barcode scanner with built-in calibration.



| Field Name | Definition |
|--|--|
| Scanner Mounting Position | Select Top or Side from the drop-down list.  NOTE: Top is the only available option with this manual release. |
| Scanner Orientation | Select Rotated Right, Forward, Rotated Left, or Backward from the drop down list. |
| Y Offset (Distance from Trigger) | Enter the distance value in the field provided. |
| X Offset (Across the Conveyer - OPTIONAL) | Enter the distance value in the field provided. |
| Z Offset (Scanner Height - OPTIONAL) | Enter the height value in the field provided. |

- When you have finished making changes, click **Update All** to save all pending changes, click **Reset All** to revert to all previously saved values, and click **Reset Page** to revert to previous saved values on the current page.

PackTrack Calibration Wizard

PackTrack is a patented operating mode for **Datalogic Omni-Directional Reading Stations** used to read and correctly assign codes read on different packs when placed in the scanner Reading Area at the same time.

See *section 5.7 PackTrack* for the complete procedure for using the wizard to set up your barcode scanner.

4.6.3 Device Settings | Device Name | Options

Use the **Options** window to configure some aspects of the scanner LEDs and X-Press interface.

To view and edit the **Options** settings:

1. In the tree menu under **Modify Settings**, navigate to **Device Settings | Device Name (if applicable) | Options**. The **Options** window opens.



NOTE: If more than one device is included in the scanning system, the device name will be listed in the menu tree after the Device Settings level.

Scanner Options

| | | |
|---------------------------|---------------------------------|---|
| Leg 1 - Scan Adjust Start | <input type="text" value="20"/> | % |
| Leg 1 - Scan Adjust Stop | <input type="text" value="70"/> | % |
| Leg 2 - Scan Adjust Start | <input type="text" value="30"/> | % |
| Leg 2 - Scan Adjust Stop | <input type="text" value="80"/> | % |
| Barcode Reconstruction | <input type="checkbox"/> | |
| Enable Stacked Codes | <input type="checkbox"/> | |

Advanced Reading Settings

| | | |
|----------------------|---------------------------------|--|
| Overflow Start Ratio | <input type="text" value="10"/> | |
| Overflow Stop Ratio | <input type="text" value="10"/> | |

Digitizer Settings

| | | | |
|-----------------------------------|---------------------------------------|---|--|
| Number of FPGA Registers to Patch | <input type="text" value="1"/> | ▼ | |
| FPGA Register 1 Offset | <input type="text" value="0"/> | | |
| FPGA Register 1 Value | <input type="text" value="0"/> | | |
| FPGA Register 1 Side to Patch | <input type="text" value="A+B Side"/> | ▼ | |

2. Enter the appropriate information in the form as described below:

| Field Name | Definition |
|---|--|
| Leg 1 (or 2) - Scan Adjust Start | Enter percentages of the total scan area (100%) for each leg of the DX8210 as illustrated in the image below. Make adjustments to narrow the reading area of each leg of the X pattern as needed for your application. |

Leg 1 (or 2) - Scan Adjust Stop

Leg 1 - Scan Adjust Start %
Leg 1 - Scan Adjust Stop %

Leg 1 - Scan Adjust Start %
Leg 1 - Scan Adjust Stop %

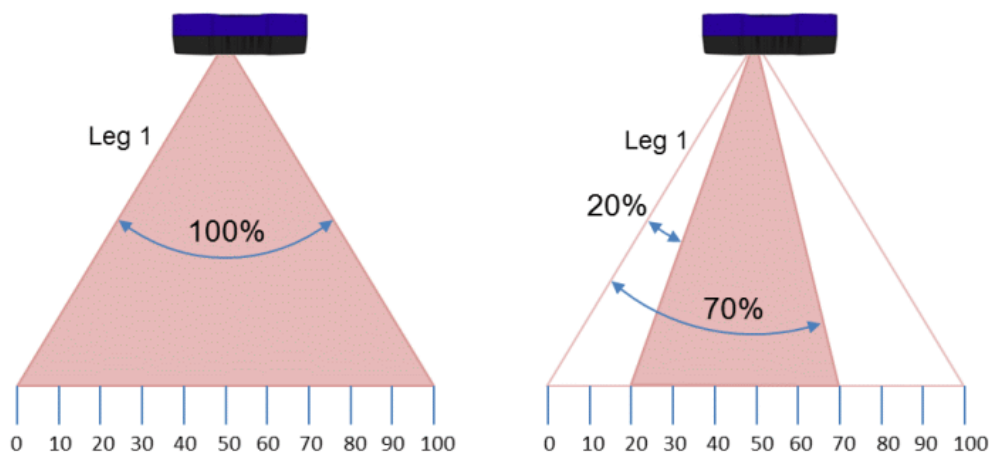

NOTE: The scan lines of the DX8210 are not completely symmetrical, so specifying the same start/end adjustments for both legs may not produce the results expected. Adjust each leg individually according to the read zone it must cover.

| | |
|-------------------------------|--|
| Barcode Reconstruction | Select the check box to enable Advanced Code Reconstruction (ACR™) when reading the code. If not checked, standard linear reading mode will be used. |
|-------------------------------|--|

| | |
|-----------------------------|---|
| Enable Stacked Codes | Select the check box to improve code reconstruction when two or more codes (of the same or different symbologies) are stacked one on top of the other with little or no space between them. |
|-----------------------------|---|

| | |
|--|---|
| Configure ETH-2 for Dedicated Setup/Aux | In a master/slave system (scanner as master, not an SC5000), this option is available for slave scanners. Select the check box to enable. |
|--|---|

This option applies to the last slave scanner in the daisy-chain system, allowing the open Ethernet port to work as a dedicated setup port. In practice, you can always communicate using this port, but selecting the check box turns off all of the other EBC traffic on that port.



CAUTION: This option must only be applied to the last slave scanner in the EBC network. Applying this option to the other slaves will disrupt the EBC network.

Advanced Reading Settings

| | |
|-----------------------------|---|
| Overflow Start Ratio | Enter the minimum expected width of the barcode starting quiet zone, expressed in number of modules from 1 to 50. |
|-----------------------------|---|

| | |
|----------------------------|---|
| Overflow Stop Ratio | Enter the minimum expected width of the barcode stopping quiet zone, expressed in number of modules from 1 to 50. |
|----------------------------|---|

| Field Name | Definition |
|---|---|
| Digitizer Settings | |
| <div style="border: 1px solid #ccc; padding: 10px; margin: 10px auto; width: 80%;"> <p>Digitizer Settings</p> <p>Number of FPGA Registers to Patch <input style="width: 100px;" type="text" value="2"/></p> <p>FPGA Register 1 Offset <input style="width: 80px;" type="text" value="0"/></p> <p>FPGA Register 1 Value <input style="width: 80px;" type="text" value="0"/></p> <p>FPGA Register 1 Side to Patch <input style="width: 100px;" type="text" value="A+B Side"/></p> <p>FPGA Register 2 Offset <input style="width: 80px;" type="text" value="0"/></p> <p>FPGA Register 2 Value <input style="width: 80px;" type="text" value="0"/></p> <p>FPGA Register 2 Side to Patch <input style="width: 100px;" type="text" value="A+B Side"/></p> </div> | |
| |  <p>WARNING: Field-Programmable Gate Array (FPGA) patches are intended for special cases only, and must only be applied with the guidance of Datalogic Support.</p> |

| | |
|---|---|
| Number of FPGA Registers to Patch | Select a number from the drop-down list. |
| FPGA Register <i>n</i> Offset | Enter the register offset in the field provided. |
| FPGA Register <i>n</i> Value | Enter the register value in the field provided. |
| FPGA Register <i>n</i> Side to Patch | Select A+B Side , A Side , or B Side from the drop-down list. “Side” refers to the laser leg of the DX8210, and allow you to choose both legs or either one. |

- When you have finished making changes, click **Update All** to save all pending changes, click **Reset All** to revert to all previously saved values, and click **Reset Page** to revert to previous saved values on the current page.

4.7 DIAGNOSTICS

Use the **Diagnostics** menu tree selections to monitor your barcode scanning system performance, view system messages, and access online help. The **Diagnostic** windows include:

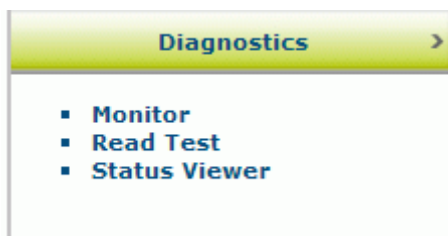

4.7.1 Diagnostics | Monitor

Use the **Diagnostics > Monitor** as the primary tool to monitor the reader's operation and bar code readability in real-time. Status indicators and vital statistics appear on a single screen, enabling you to effectively and efficiently detect and troubleshoot any problems that may occur.

To open the Monitor window:

In the tree menu under **Diagnostics**, navigate to **Monitor**. The **Monitor** window opens.

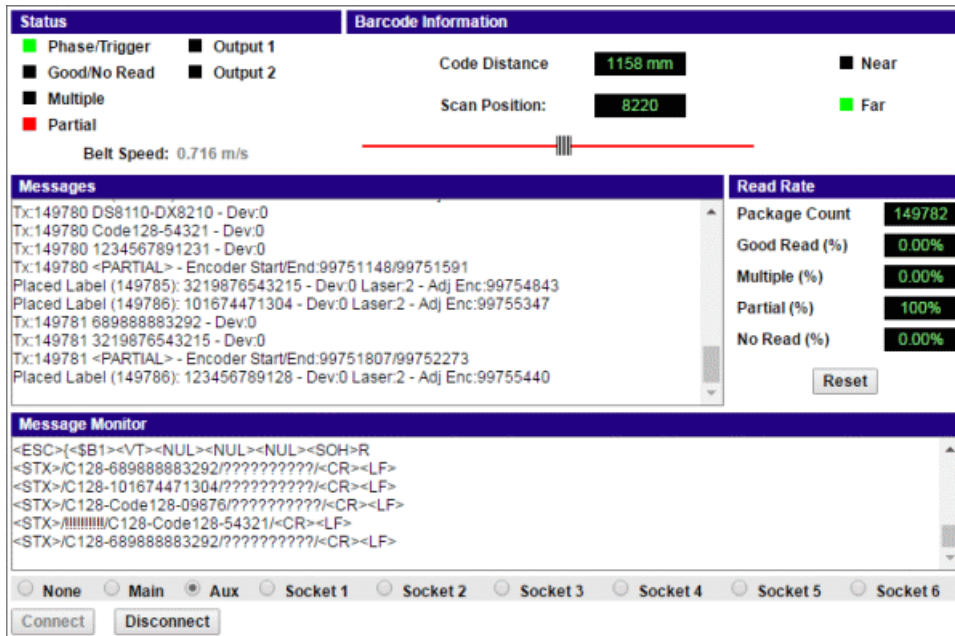

The status indicators in **Diagnostics > Monitor** indicate the following conditions:

| Field | Definition |
|----------------------------|--|
| Status | |
| Phase/Trigger | GREEN indicates trigger input. The LED is activated upon trigger input regardless of trigger source (including software trigger). |
| Good/No Read | GREEN indicates a good (valid) bar code has been decoded. RED indicates a no-read (or incomplete decode). |
| Multiple | RED indicates more codes than desired were read. |
| Partial | RED indicates a partial read. |
| Output 1 / Output 2 | RED indicates activity on that output. |
| Belt Speed | Indicates the current speed of the belt indicated by the encoder (tachometer). |

| Barcode Information | |
|------------------------------|---|
| Code Distance (cm) | Displays the distance from the laser origin to the scanned barcode. |
| Scan Position | Displays the position of the code in the scan line. |
| Near | GREEN indicates the barcode has been scanned by the near-focus laser. |
| Far | GREEN indicates the barcode has been scanned by the far-focus laser. |
| Messages | |
| Message Field | Displays message data being returned by the scanner for each barcode scanned. |
| Read Rate | |
| Package Count | Displays the number of packages detected since the last reset. |
| Good Read (%) | Displays the number of good barcode reads since the last reset. |
| Multiple (%) | Displays the number of multiple barcodes detected since the last reset. |
| Partial (%) | Displays the number of partially read barcodes since the last reset. |
| No Read (%) | Displays the number of no reads (no barcode read on package) since the last reset. |
| Reset | Click to reset the above counters. |
| Message Monitor | |
| Message Monitor Field | Select the option button beside Main, Aux, Socket 1, Socket 2, Socket 3, Socket 4, Socket 5, or Socket 6 to display messages for that host port. Select the option button beside None to stop displaying messages. |
| Connect/ Disconnect | Click Disconnect to stop (freeze) the Monitor window, or click Connect to start the Monitor window. |

4.7.2 Diagnostics | Read Test

Use the Read Test window to check how well a scanner is operating.

To test a scanner's operation:

1. In the tree menu under **Diagnostics**, navigate to **Read Test**. The **Read Test** window opens.

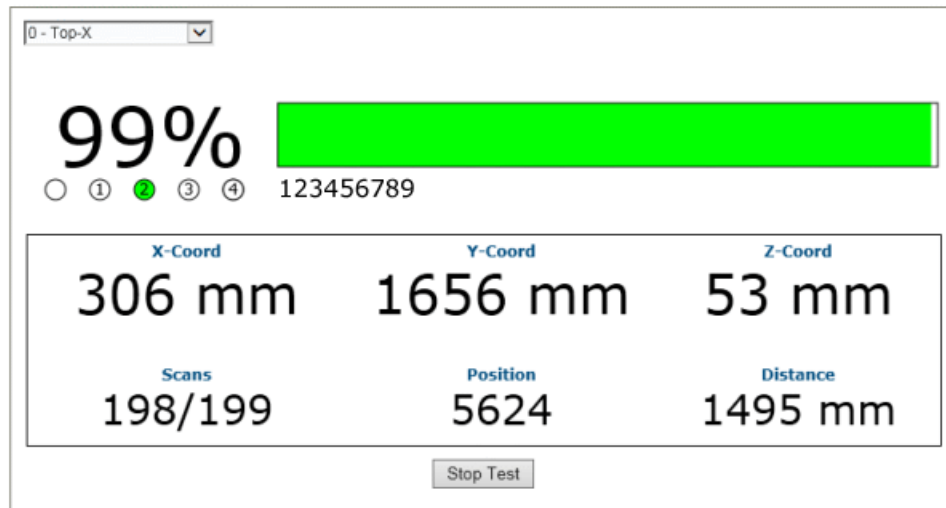

2. If there are multiple scanners in the system, select the scanner to test from the drop-down list at the top of the **Read Test** window.
3. Click the **Start/Stop Test** toggle button to run or stop the real-time performance display of the scanner.

The Read Test displays the following information:

- **Read Rate:** This is the percentage readout and bar at the top of the window, displaying the read rate since the start of the test.

The numbered circle indicators below the read-rate percentage indicate in **GREEN**, which of the scanner's lasers is reading the barcode.

The alpha numeric text following the numbered circle indicators is the barcode data.

- **Laser Identifiers:** These circles below the Read Rate percentage identify the number of lasers in the scan head as well as highlighting in GREEN the laser that is reading the barcode. In the example above, the scanner has four lasers and laser 2 is identified as reading the code. If the first circle is highlighted in RED, this indicates a NOREAD.
- **XYZ Coord:** This displays the real-time coordinates of the barcodes being read.
- **Scans:** Displays the number of times the scanner decoded the test barcode out of the number of opportunities it had to decode the test barcode during a test cycle.
- **Position:** Displays the position of the barcode in the scan line.
- **Distance:** Displays the distance from the laser origin to the last barcode read.

4.7.3 Diagnostics | Status Viewer

Use the **Status Viewer** to check up on your scanner health.

To access and use the Status Viewer:

1. In the tree menu under Diagnostics, navigate to Status Viewer. The Status Viewer window opens.

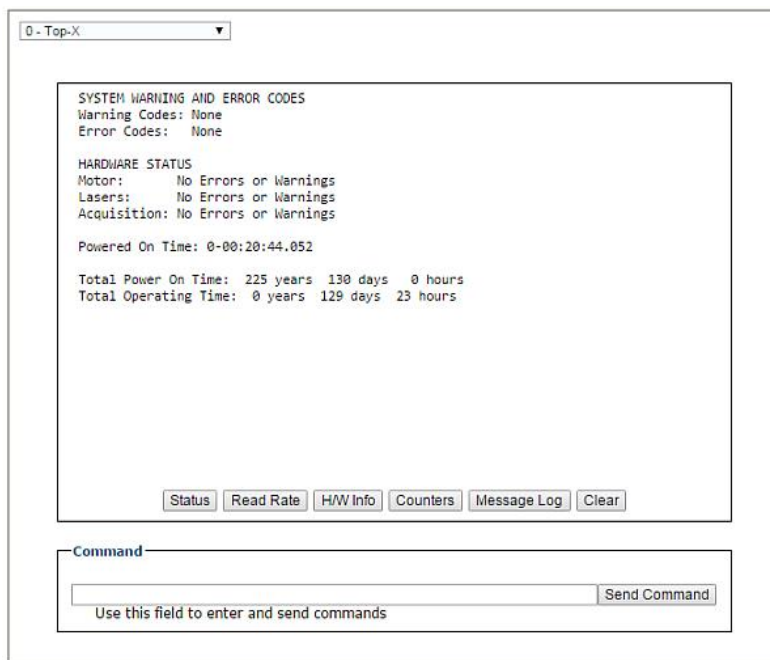

2. Select a device to view from the drop-down list at the top-left corner of the window.
3. Click on a button at the bottom of the display window to select the type of information you want to view:
 - **Status:** displays system warnings or errors.

```

SYSTEM WARNING AND ERROR CODES
Warning Codes: None
Error Codes: None

HARDWARE STATUS
Motor: No Errors or Warnings
Lasers: No Errors or Warnings
Acquisition: No Errors or Warnings

Total Power On Time: 225 years 172 days 8 hours
Total Operating Time: 0 years 172 days 7 hours
  
```

- **Read Rate:** displays read rate and package count information.

```

READ RATE
Total Packages:      34204
Good Reads:         25086    73%
No Reads:           837      2%
Partial:            8281    24%
Multiple:           0        0%
    
```

- **H/W Info:** displays information about the selected hardware, including model, serial number, scans/second, laser information, and more.

```

CONFIGURATION
Model Type: DS8110-2100
Serial Num: C14C03507
Mac Address: 00-07-be-00-ef-8a
Num Lasers: 2
Num Legs: 1
Num Facets: 7

CURRENT STATUS
Scan Rate:      1000 scans/sec
Current APD DAC: 469

      Temp      VCC
Laser 1:    40.59 C    3.2790
Laser 2:    40.89 C    3.2722
Logic Board: 39.00 C
APD Board:  41.50 C
    
```

- **Counters:** displays cumulative data about scans, triggers, errors, and much more.

```

SYSTEM INFO
Scan Rate (scans/sec): 999      Belt Speed (m/s): 1.55
Tach Rate (cnts/sec) : 2429    Belt Speed (ft/min): 306

DECODER COUNTERS
Scan Ints:      14796      DSP Codes:      59214
Triggers:      59548      DSP Triggers:   960
Process L0:    25824      Process L1:     0
Max Elements L0: 310      Max Elements L1: 0
Queue Size:    1          Queue Max:      9
Mem Alloc Err: 0          Memory Full:    0

SCAN DATA EXCEPTION COUNTERS
Missed DMA:    0          Missed QDMA:    0
Xfer Overflow: 0          Xfer Bad Length: 0
ASTRA Seg Err: 0          Invalid Leg No: 0
Low Term Count: 0         High Term Count: 0
Motor Var Cnt: 0

ARM Restarts:  0          DSP Restarts:   0
    
```

- **Message Log:** displays messages logged since the last clear command.

```
0-00:00:00.723: APD Read: DAC/Temp Ref: 243/6400
0-00:00:00.723: APD Read: Gain/Offset/Min/Max/Type: -1/-1/-1/-1/-1
0-00:00:00.725: APD DAC Initialized.
0-00:00:00.852: ADC Configuration Complete.
0-00:00:00.959: Loading FPGA file XLC_v20_0_0.fpga.
0-00:00:03.938: FPGA device id: 4c55.
0-00:00:03.938: FPGA version: 6.0(0).
0-00:00:06.378: Loading DSP file Decoder_release_v1_8_17_0.dsp.
0-00:00:06.678: DSP load complete.
0-00:00:06.678: Scan Engine Started.
0-00:00:06.679: FPGA Buffer Export Task Started
0-00:00:14.664: Motor Speed Threshold set to 0xFFFF.
0-00:00:14.664: FIR Filter Coefficients Loaded.
0-00:00:14.664: Scan FOV set to 88 deg (off=1562 len=21420)
0-00:00:15.263: Ethernet Initialization Complete.
0-00:00:15.263: Web Server Initialization Complete.
0-00:00:16.665: DSP Version 1.8.17 Started.
0-00:00:16.665: Scan Engine Initialized.
0-00:00:16.686: IsAlone=0 IsMaster=0 NumDevices=3
Powered On Time: 0-00:38:22.825
```

4. Click **Clear** to clear out the **Message Log**.

You can also enter a specific system command in the field provided at the bottom of the window. Click **Send Command** to execute.

4.8 UTILITIES

Use the **Utilities** menu tree selections to backup, restore, and update system firmware, or to reboot the scanner. The **Utilities** windows include:



4.8.1 Utilities | Backup or Restore

Use **Backup or Restore** to save all the settings to the scanner and backup the settings to the backup module and/or file.

To use the Backup or Restore functions:

1. In the tree menu under **Utilities**, click **Backup or Restore** Info. The **Backup or Restore** window opens.

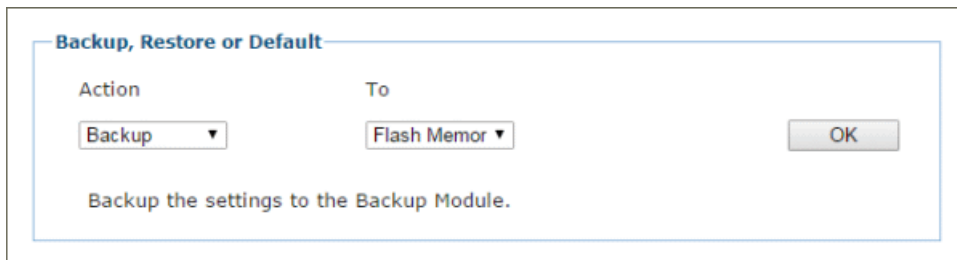

2. From the drop-down lists shown, select an **Action** and a **To/From** option.

| Action | To/From | |
|---------------|---------------------|--|
| Backup | Flash Memory | When this option is selected, click OK to save the settings to the Backup Module (BM100) in the CBX Connection Box. A progress box displays the percent complete of the save operation. |

Utilities | Backup or Restore

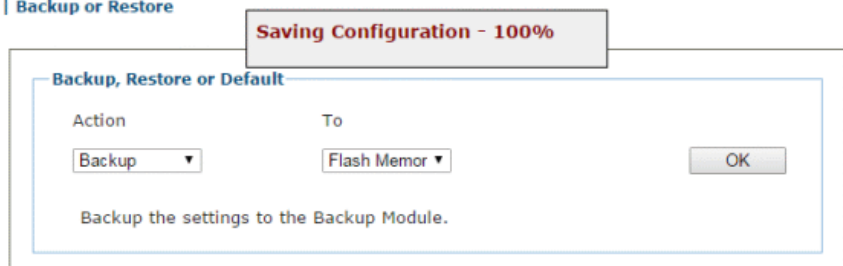

| | |
|-------------|--|
| File | When this option is selected, click OK to download the file to your computer. The file can then be saved to an appropriate backup folder. |
|-------------|--|

| Action | To/From | |
|----------------|---------------------|--|
| Restore | Flash Memory | When this option is selected, click OK to retrieve the settings to the Backup Module in the CBX. A progress box displays the percent complete of the restore operation. |

File When this option is selected, a **Choose File** button is revealed. Click **Choose File** to open a file browser and located the settings .txt file to be restored. When the file has been located and selected, click **OK** to save the file to the device.

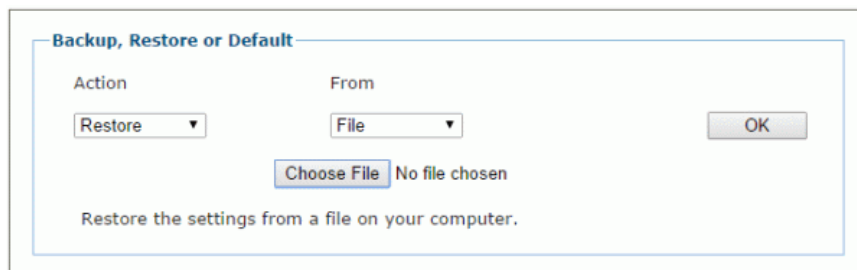

Default Application When this option is selected, click **OK** to restore application settings to Factory defaults, except for Ethernet and PackTrack.

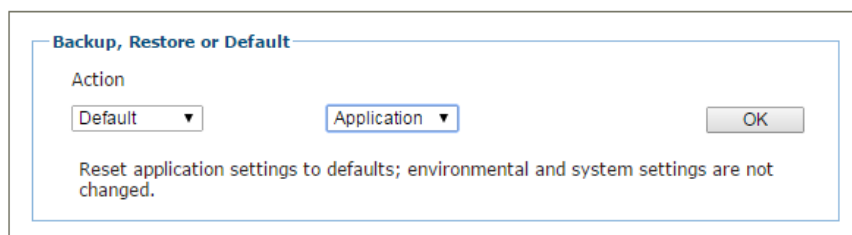

App and Env When this option is selected, click **OK** to restore all settings including Ethernet and PackTrack.

All When this option is selected, click **OK** to **COMPLETELY RESET** the scanner to Factory configuration.

4.8.2 Utilities | Reboot

Use the **Reboot** window to restart the scanner or system.

To use the Reboot function:

1. In the tree menu under **Utilities**, click **Reboot** Info. The Reboot window opens.

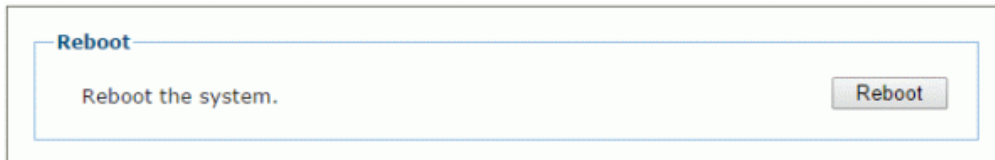

2. Click **Reboot**. A confirmation box appears.

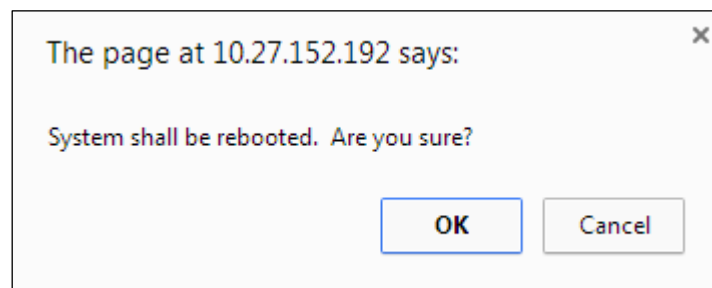

3. Click **OK** to reboot the system, or click **Cancel** to return to the reboot window without restarting the system.

4.8.3 Utilities | Update Firmware

Use **Update Firmware** to reload the scanner system firmware.



CAUTION: This function should only be performed under the guidance of Datalogic Technical Support.

To Extract Image:

1. In the tree menu under **Utilities**, click **Update Firmware**. The **Update Firmware** window opens.

To Burn Flash

1. Click Browse.
2. In Open window, open an image file (*.as) to burn to flash.
3. Click Burn Flash. The graphic on-screen indicates Burn Flash is in-process.
4. A message will appear when Burn Flash is complete.
5. Reboot (cycle power) your scanner.

To Extract Image

1. Click Extract Image.
2. In Save window, save the image (*.as) file to your computer. The graphic on-screen indicates Extract Image is in-process.
3. A message will appear when Extract Image is complete.



Extract Image



Choose File No file chosen

Burn Flash



Reboot

2. Click **Extract Image**. A confirmation box appears.

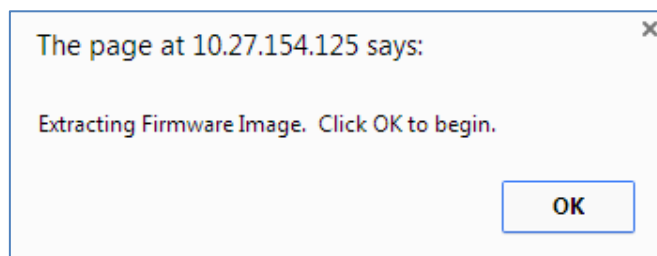

3. Click **OK** to continue.

4. The graphic on screen indicates **Extract Image** is in-process. A message will appear when **Extract Image** is complete.

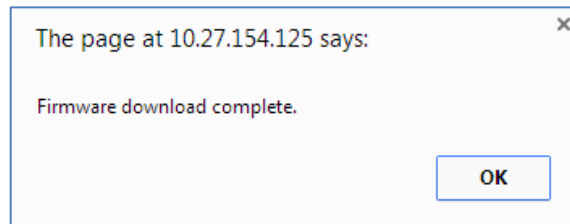

To Burn Flash:

1. Click **Choose File**. In the browse window, select an image file (*.as) to burn to flash.



NOTE: The appearance of these functions may vary from browser to browser.

2. Click **Burn Flash**. The graphic on-screen indicates **Burn Flash** is in-process.
3. A message will appear when **Burn Flash** is complete.

To Reboot the System:

1. Click **Reboot**. A confirmation box appears.

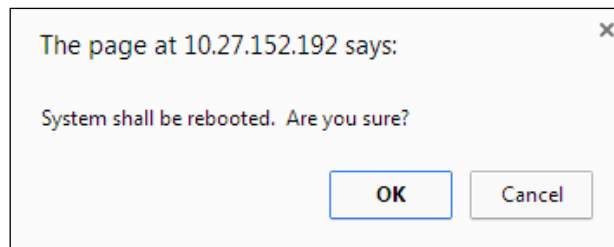

2. Click **OK** to reboot the system, or click **Cancel** to return to the reboot window without restarting the system.

4.8.4 Utilities | Help

e-Genius provides complete online help.

To use the Help system:

In the tree menu under **Utilities**, click **Help**. The **Online Help** window opens.

The **Welcome** page provides important product information as well as three ways to find specific help information: **Contents**, **Index**, and **Search**.

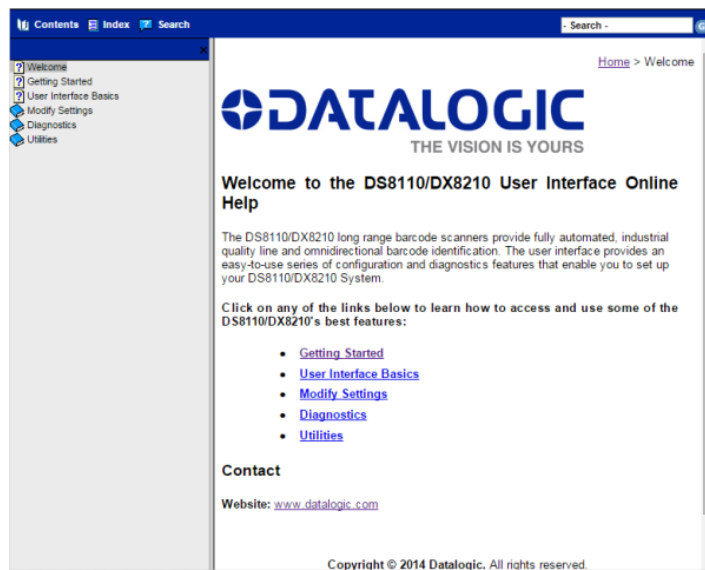

To display contextual help for a current window:

Click the **Help Icon**  displayed at the top right of the screen. A help window appears, providing you with information for that specific page.

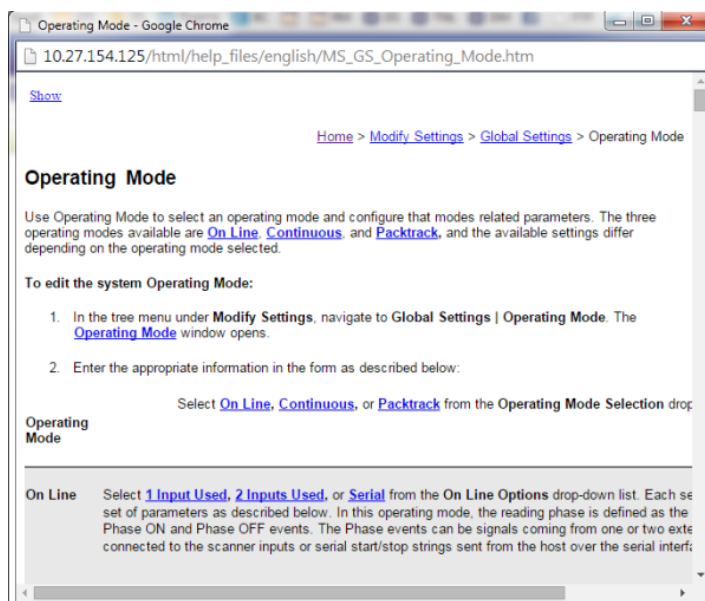

Click the **Show** link in the upper left corner of the help window to access Contents, Index, and Search options.

5 BARCODE SCANNING FEATURES

This chapter provides details on how the DX8210 Barcode Scanning System functions during normal operation. It also helps familiarize the user with status indicator LEDs, Control Panel operation, system setup, and how the scanners can be easily and quickly replaced with a new unit if necessary.



IMPORTANT: The procedures outlined in this chapter should only be performed by a Datalogic trained technician.

For further information on training, contact us through the Datalogic website at www.datalogic.com.

5.1 FIRST-TIME STARTUP



NOTE: Before starting up or testing the scanner, it must be connected to a CBX510 Connection Box or an SC5000 Controller depending on the system configuration.

On initial power-up, the DX8210 performs a series of self-diagnostic and LED tests. The complete power-up sequence takes about 20 seconds. When the **READY** LED flashes and turns a steady green the power-up sequence is complete, and the scanner is operational.

5.1.1 Default Parameters

The barcode scanners are shipped from the factory with these defaults:

- Default Password: DLA
- Control Panel Buttons Enabled
- Code 128 (10-30 characters), Code 39
- IP address HOST (ETH1) 172.27.101.220; Setup 192.168.3.100 (ETH2)

Perform the following setup procedure using these defaults or configure your Barcode scanner with your application's parameters using **e-Genius** (see *Chapter 4*).

5.1.2 Check Operations using Test Mode



NOTE: Perform the following test using a bar code that matches the default parameters. A barcode test chart is included in the box with each scanner, and a code from the chart can be used to perform the test

If the default parameters have been changed, you must enable the control panel buttons and the other default parameters listed.

To quickly check DX8210 operation:

1. Make sure the scanner is connected to a CBX510 or SC5000.
2. Apply power to the reader.

3. Press and hold the X-Press button until the first two red LEDs light, and then release the button.
4. Position a test barcode symbol approximately 750 mm [30 inches] from the reader. Skew the bar code symbol slightly.
5. The laser(s) should be scanning continuously during normal operations. (Observe the laser safety warnings.)
6. Observe the LEDs. The LEDs illuminate when the reader is scanning and decoding the bar code symbol, and indicate the rough read rate of the scan (see 5.5.1).

5.2 BASIC INSTALLATION PROCEDURES WITH THE CBX510

1. Mechanically install the scanner(s) according to the application drawing for your system.
2. Install the CBX510 according to the application drawing or in a location for best wiring access to scanner(s), encoder (tachometer), and photoelectric sensor.
3. If using more than one scanner, connect the host cable to ETH1 of the designated Master. Then wire ETH2 from the Master to ETH1 of the first Slave, and then from the first slave ETH2 to ETH1 of the next slave and so on.
4. Connect the 25 pin I/O communication cable from the scanner (Master only in multihead systems) to the CBX510.
5. Wire the encoder (tachometer) and photoelectric sensor into the CBX510 (see sections 3.9 and 3.11).
6. After the scanner(s), CBX510, and accessories have been carefully wired, apply power to the system.
7. When everything is powered up, connect a laptop to the ETH2 of the scanner (last slave in a multihead system.)
8. Open a browser and enter the default IP (192.168.3.100, see section 4.5.7.). **e-Genius** opens.



NOTE: Detailed information on connecting a laptop to the system and using **e-Genius** is available in *Chapter 4*.

9. Log on to **e-Genius** (see section 4.1.2.).
10. From the menu tree, select **Modify Settings | System Info**.

11. Select **Standalone** (single head) or **Master** (multihead) from the **Role** drop-down list.
12. If Master is selected, the system is poled, and the other scanners are added to the Device information list.

13. From **Modify Settings | Global Settings | Operating Mode**, select a mode, trigger source, encoder setting.

Operating Mode

Operating Mode Selection Packtrack ▼

Trigger Source

Start Input Number Trigger (Input 1) ▼

Start Input Active Level Active Closed ▼

Stop Phase Edge Trailing ▼

Mode Settings

Distance from PS Line to Tx Line 2499 mm

PS Line 0 mm

Minimum Pack Length 51 mm

Minimum Distance Error Behaviour Compose ▼

Minimum Distance Between Packs 30 mm

Window Dimension 15 mm

Encoder Settings

Physical Encoder Enable ▼

Encoder Step (hundredths of millimeter) 64

Beam Shutter Settings

Beam Shutter Triggered ▼

PackTrack Beam Shutter Timeout 10 min ▼

Update All Reset All Reset Page

14. Adjust the barcode settings in **Modify Settings | Global Settings | Barcode Settings Table** according to the needs of your system.

Barcode Settings

| Idx | Symbology | Minimum Length | Maximum Length |
|------------------------------------|-----------|----------------|----------------|
| <input checked="" type="radio"/> 1 | Code 128 | 10 | 12 |
| <input type="radio"/> 2 | Code 39 | 4 | 40 |
| <input type="radio"/> 3 | EAN-13 | 13 | No Add On |
| <input type="radio"/> 4 | UPC-A | 12 | No Add On |
| <input type="radio"/> 5 | Disabled | | |

Barcode 1

Enable

Code Symbology Code 128 ▼

Minimum Label Length 10

Maximum Label Length 12

Match String Rule Match ▼

Pattern Match String ✎

Options

Decoding Safety 1

Bar Count Variable ▼

Match Direction Rule Disable ▼

Update All Reset All Reset Page

- In **Modify Settings | Global Settings | Barcode Configuration** select single, multiple, or logical combination of labels, based on your application.



- Move through the menu tree to configure **Serial Ports, Ethernet, and Messaging** settings based on your application requirements.

- In **Global Settings | Messaging | Message Format** change the **Message Tx Selection** to **After Reading Phase OFF**.

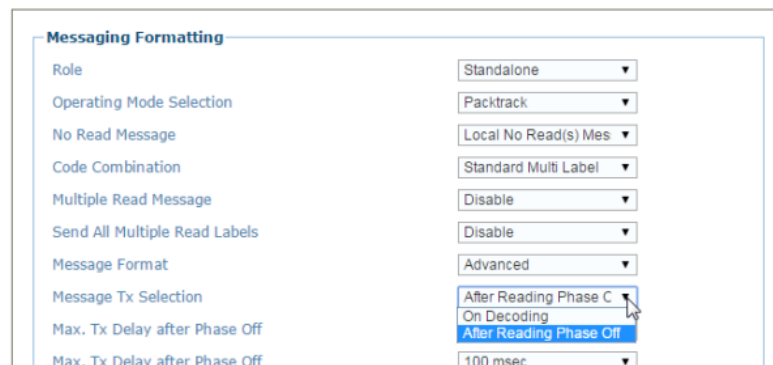

- Run the **PackTrack** calibration procedure (see section 5.7).
- When the scanner(s) has been configured and calibrated, backup the system configuration using **Utilities | Backup or Restore**. It is recommended to save the system parameters to the backup module on the CBX510 and to a file on your computer.

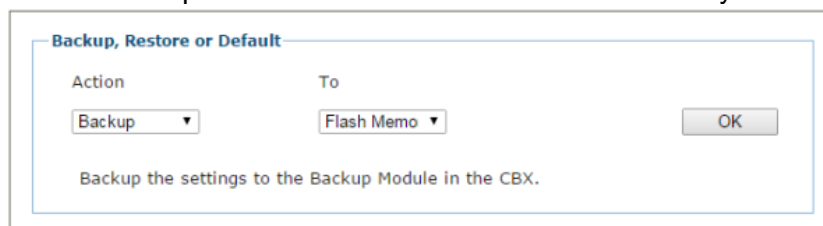

- Select **Backup** from the **Action** drop-down list, and select **Flash Memory** from the **To** drop-down list.

- Click **OK**. The following message will be displayed.



- Next, select **Backup** from the **Action** drop-down list, and select **File** from the **To** drop-down list.

- Click **OK** to download the configuration text file (param.txt) to your computer.

5.3 BASIC INSTALLATION WITH SC5000 CONTROLLER

1. Mechanically install the scanners according to the application drawing for your system.
2. Install the SC5000 according to the application drawing or in a location for best wiring access to scanner(s), encoder (tachometer), and photoelectric sensor.
3. Connect the host cable to the HOST of the SC5000 (see figure below). Next, wire ETH2 from the SC5000 to ETH1 of the first Slave, and then from the first slave ETH2 to ETH1 of the next slave and so on. If wiring the scanners in a complete ring configuration, connect ETH2 of the last slave in the series to ETH1 of the SC5000.



Figure 41 - SC5000 Standard Model Connector Panel

- | | | | |
|---|----------------------------|---|------------------------------------|
| ① | CFG – Configuration | ⑥ | 25-Pin D, Scanner Connector |
| ② | Host | ⑦ | ENC – Encoder/Tachometer |
| ③ | ETH2 – EBC scanner network | ⑧ | TRG – Trigger/Photoelectric Sensor |
| ④ | ETH1 – EBC scanner network | ⑨ | Watertight Wire Seals |
| ⑤ | PWR – Power | ⑩ | Connector Add-On Panel |

4. Connect the encoder (tachometer) and photoelectric sensor (trigger) to the bottom of the SC5000 Controller (see figure above).
5. Connect the (unpowered) Power supplies to the scanners and SC5000.
6. After the scanner(s), SC5000, and accessories have been carefully wired, apply power to the system.

7. When everything is powered up, connect a laptop to the CFG port on the front of the SC5000.
8. Open a browser and enter the default IP (192.168.3.100, see section 4.1.2). **e-Genius** opens.



NOTE: Detailed information on connecting a laptop to the system and using **e-Genius** is available in *Chapter 4*.

9. Log on to the **e-Genius** (see section 4.1.2.).
10. From the menu tree, select **Modify Settings | System Info**.

System Info

System Description

Role

Enable Automatic Slave Replace

Master Tools

Device Information

| Model | Dev | MAC Addr | Software Version | Description | |
|-------|-----|--------------|----------------------|---------------|----|
| | 0 | 0007BE0099C2 | ARM_release_v2_0_0_0 | SC5000 | |
| | 1 | 000E13040075 | ARM_release_v2_0_0_0 | DrumScanner | ID |
| | 2 | 000E13041212 | ARM_release_v2_0_0_0 | DrumXScanner | ID |
| | 3 | 000E13040114 | ARM_release_v2_0_0_0 | TableXScanner | ID |
| | 4 | 0007BE00DAF6 | ARM_release_v2_0_0_0 | TableScanner | ID |

Additional Devices

Send Barcodes to Non-Singulated Dimensioning System

Dimensioning System Info

IP Address

Port Number

Enable Tach Sync

11. If Master is selected, the system is poled, and the other scanners are added to the Device information list. The SC5000 Controller always serves as the Master when used.

12. From **Modify Settings | Global Settings | Operating Mode**, select a mode, trigger source, encoder setting.

Operating Mode

Operating Mode Selection Packtrack ▼

Trigger Source

Start Input Number Trigger (Input 1) ▼

Start Input Active Level Active Closed ▼

Stop Phase Edge Trailing ▼

Mode Settings

Distance from PS Line to Tx Line 2499 mm

PS Line 0 mm

Minimum Pack Length 51 mm

Minimum Distance Error Behaviour Compose ▼

Minimum Distance Between Packs 30 mm

Window Dimension 15 mm

Encoder Settings

Physical Encoder Enable ▼

Encoder Step (hundredths of millimeter) 64

Beam Shutter Settings

Beam Shutter Triggered ▼

PackTrack Beam Shutter Timeout 10 min ▼

Update All Reset All Reset Page

13. Adjust the barcode settings in **Modify Settings | Global Settings | Barcode Settings Table** according to the needs of your system.

14. Adjust the barcode settings in **Modify Settings | Global Settings | Barcode Settings Table** according to the needs of your system.

Barcode Settings

| Idx | Symbology | Minimum Length | Maximum Length |
|------------------------------------|-----------|----------------|----------------|
| <input checked="" type="radio"/> 1 | Code 128 | 10 | 12 |
| <input type="radio"/> 2 | Code 39 | 4 | 40 |
| <input type="radio"/> 3 | EAN-13 | 13 | No Add On |
| <input type="radio"/> 4 | UPC-A | 12 | No Add On |
| <input type="radio"/> 5 | Disabled | | |

Barcode 1

Enable

Code Symbology Code 128 ▼

Minimum Label Length 10

Maximum Label Length 12

Match String Rule Match ▼

Pattern Match String

Options

Decoding Safety 1

Bar Count Variable ▼

Match Direction Rule Disable ▼

Update All Reset All Reset Page

15. In **Modify Settings | Global Settings | Barcode Configuration** select single, multiple, or logical combination of labels, based on your application.



16. Move through the menu tree to configure **Serial Ports, Ethernet, and Messaging** settings based on your application requirements.

17. In **Global Settings | Messaging | Message Format** change the **Message Tx Selection** to **After Reading Phase OFF**.

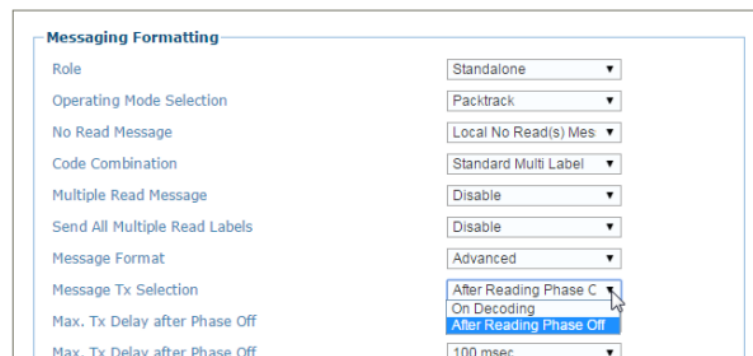

18. Run the **PackTrack** calibration procedure (see section 5.7).

19. When the scanner(s) has been configured and calibrated, backup the system configuration using **Utilities | Backup or Restore**. It is recommended to save the system parameters to *Flash Memory* on the SC5000 and to a *File* on your computer.

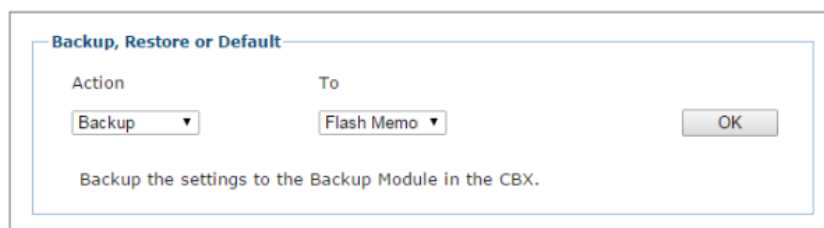

20. Select **Backup** from the **Action** drop-down list, and select **Flash Memory** from the **To** drop-down list.

21. Click **OK**. The following message will be displayed.



22. Next, select **Backup** from the **Action** drop-down list, and select **File** from the **To** drop-down list.

23. Click **OK** to download the configuration text file (param.txt) to your computer.

5.4 LED INDICATORS

The DX8210 barcode scanners have several pipe LEDs spanning the top and front panel.

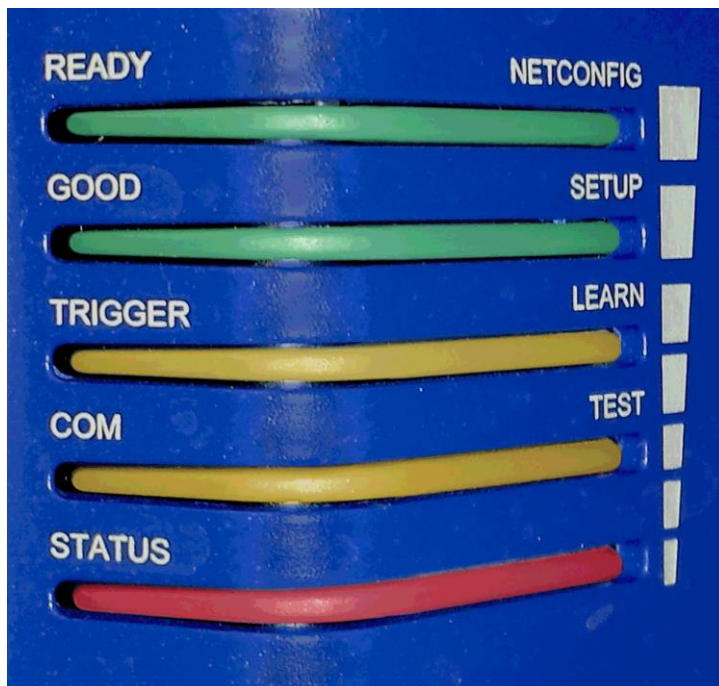



Figure 42: LED Indicators

The indicators have the following meanings:

| LED | Description |
|-------------------|--|
| READY / NETCONFIG | Solid GREEN indicates the device is ready to operate. |
| GOOD / SETUP | Flashes GREEN to indicate a barcode was successfully read. |
| TRIGGER / LEARN | Flashes YELLOW to indicate an active external presence sensor.  NOTE: When operation mode is set to PackTrack (see section 4.5.1), these LEDs are inactive on slave scanners. |
| COM / TEST | Flashes YELLOW to indicate data transmitting from main serial port.  NOTE: When operation mode is set to PackTrack (see section 4.5.1), these LEDs are inactive on slave scanners. |
| STATUS | Flashes RED on a NO READ |

For alternate functions, see 5.5.1 X-Press Human Machine Interface below.

5.5 CONTROL PANEL BUTTONS

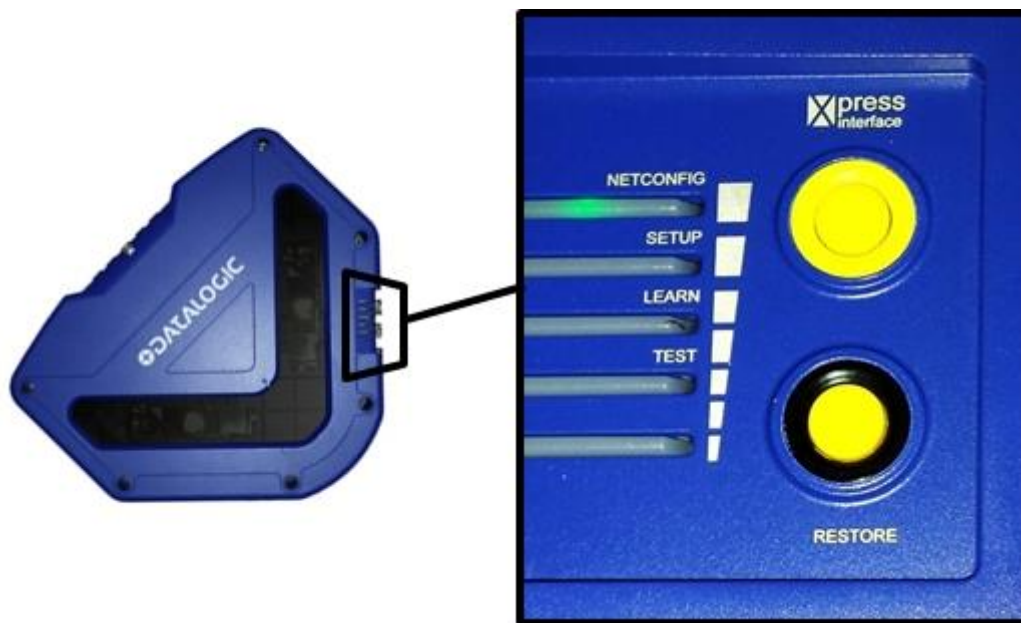

Figure 43: Control Panel Buttons

5.5.1 X-Press™ Human Machine Interface

X-Press is the intuitive Human Machine Interface designed to improve ease of installation and maintenance.

Status information is clearly presented by means of the five colored LEDs, whereas the single push button gives immediate access to the following relevant functions:

- **TEST** with bar graph visualization to check static reading performance
- **LEARN** to self-detect and auto-configure for reading unknown codes
- **SETUP** to allow the open Ethernet port in the last slave scanner in a Master/Slave system to work as a dedicated setup port
- **NETCONFIG** to locate and configure slave scanners in a array (tunnel)

X-PRESS FUNCTIONS

Quick access to the following functions is provided by an easy procedure using the push button:

1. Press the button (the Status LED will give a visual feedback).
2. Hold the button until the specific function LED is on (**TEST, LEARN, SETUP, or NETCONFIG**).
3. Release the button to enter the specific function.

Once button is pressed and held, the cycle of LEDs activation is as follows:

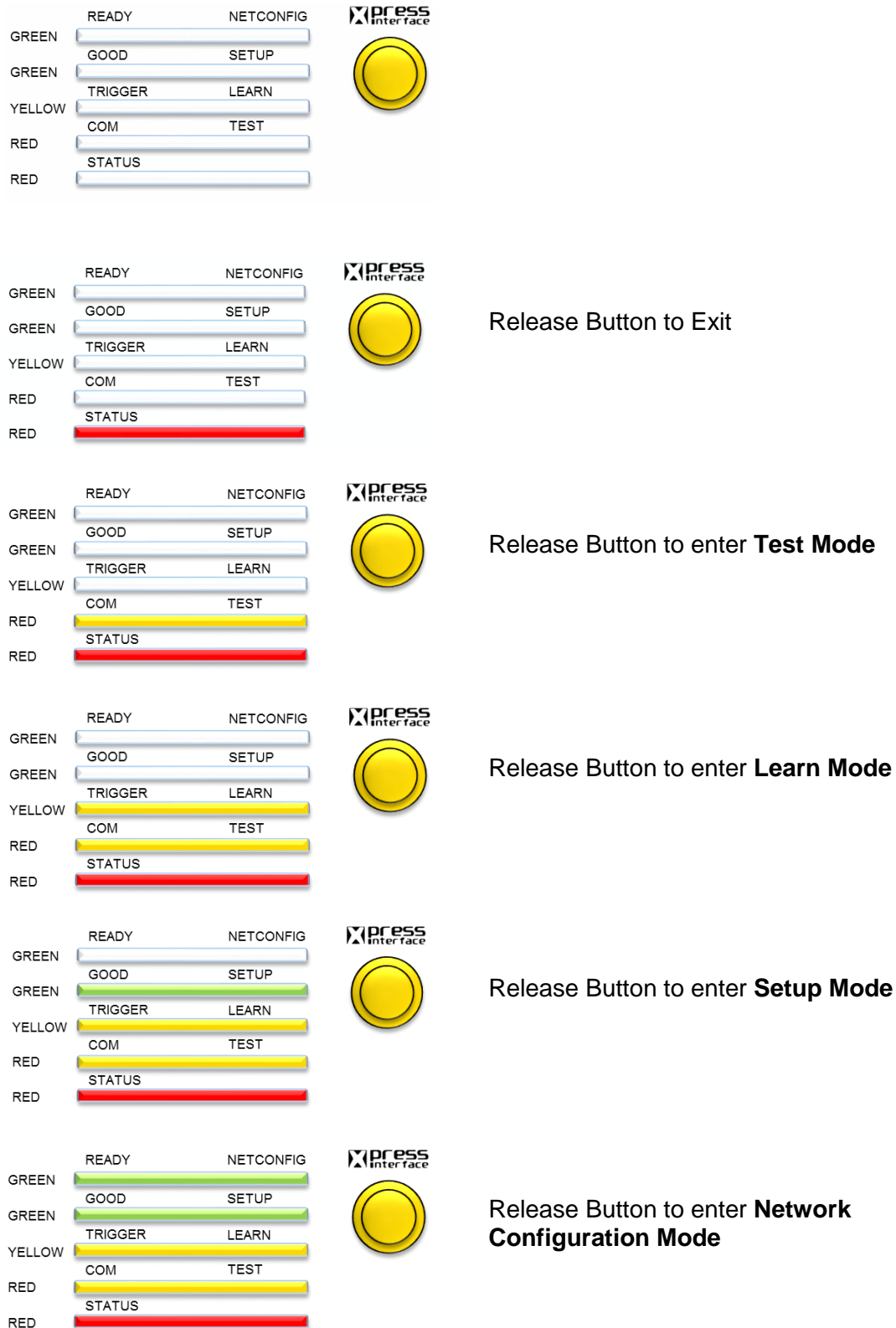

Figure 44: X-Press LED modes

TEST MODE

Once entered, the five LEDs are activated and if the scanner starts reading barcodes. The LEDs indicate the read rate percentage. In case of a NO READ condition, only the Status LED is on and blinks.

The LEDs indicate the read rate percentage as follows:

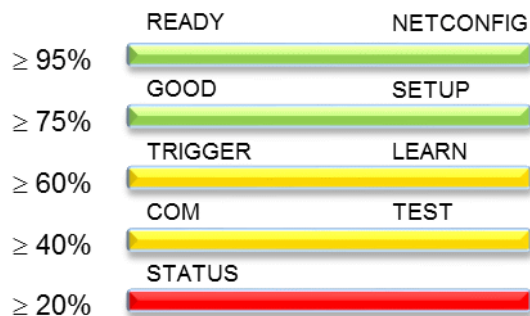

Figure 45: X-Press LED test mode read rate percentages

To exit the **Test Mode**, press the **X-PRESS** push button once.



NOTE: By default, the Test exits automatically after two minutes.

LEARN

Once entered, the **LEARN** LED blinks and scanner starts a procedure to automatically detect and recognize barcodes, which are presented to it.

Place a barcode into the scan line and the **LEARN** LED goes solid for a short time as Processing and Decoding parameters are successfully saved.

If the calibration cannot be reached after a timeout of about 3 (three) minutes, the scanner will exit Learn Mode without saving the parameters.

SETUP

This mode is available in a master/slave system (scanner as master, not an SC5000.)

This option applies to the last slave scanner in the daisy-chain system, allowing its open Ethernet port to work as a dedicated setup port.

In practice, you can always communicate using this port, but the Setup Mode turns off all of the other EBC traffic on that port.



CAUTION: This option must only be applied to the last slave scanner in the EBC network. Applying this option to the other slaves will disrupt the EBC network.

NETCONFIG

Once entered from a Master scanner in a multi-scanner array (tunnel), the system detects and identifies Slave scanners in the array. The Slave scanners (and the Master) will then be available in **e-Genius** (see *chapter 4*).

Press the X-PRESS button once again to exit.

5.5.2 Restore Button and Other Functions

| Function | Description |
|--|---|
| Scanner Replacement | Hold down RESTORE button until all LEDs turn on. After all LEDs go off, then READY LED comes back on. Parameters stored in the CBX510 are now being used in the scanner. |
| Software Recovery Mode | Hold down X-Press button while scanner is powered up. |
| Reset Scanner to Factory Defaults | Hold down X-Press and RESTORE buttons while scanner powers. When default is successful, all LEDs will flash 3 times. |

5.6 BUILT-IN CALIBRATION FOR TOP-MOUNT

When installing a top mounted DX8210 scanner, the **Use Built-in Calibration** selection in the **Device Settings | Device Name | Mounting** window can be used as a quick alternative to the **PackTrack Wizard**.

To Use the Built-in Calibration:

1. In the tree menu under **Modify Settings**, navigate to **Device Settings | Mounting**. The **Mounting** window opens.
2. Select **Use Built-in Calibration** from the **Calibration Method** drop-down list. The **Scanner Orientation** window appears.

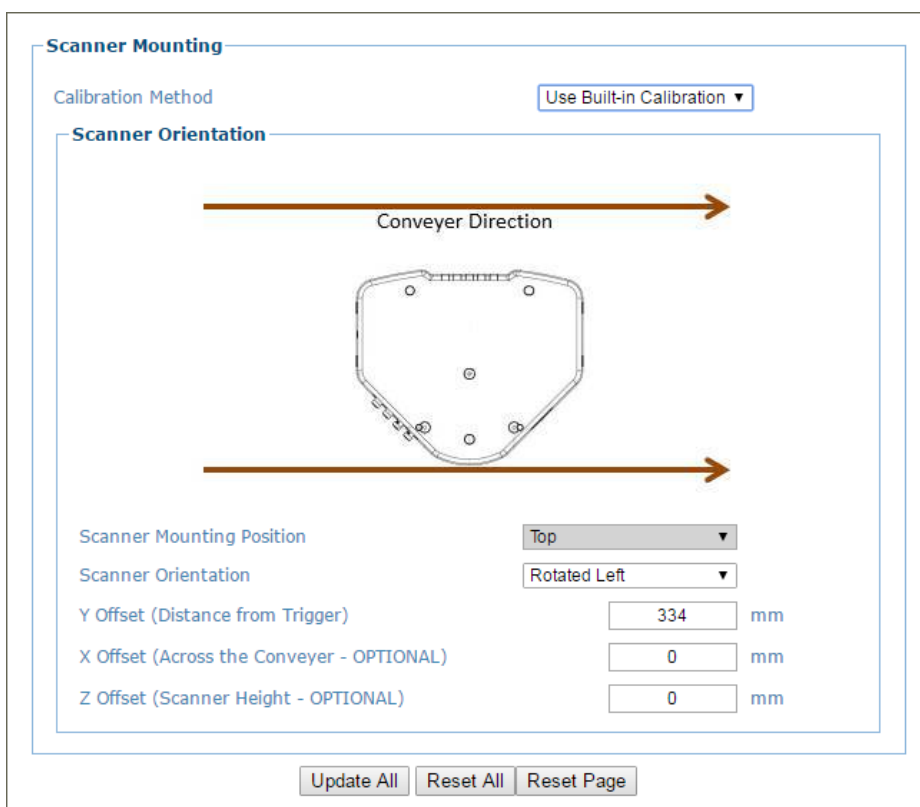

3. Select the scanners orientation to the conveyer from the **Scanner Rotation Angle** drop-down list. Selections include:

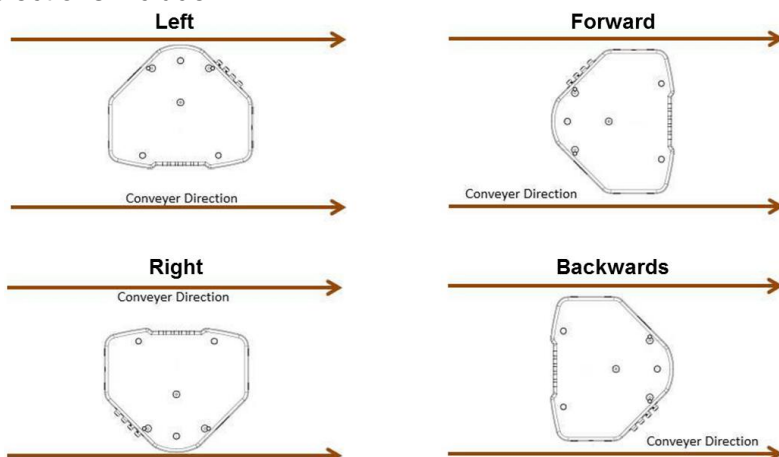

4. With the scanner powered on and the conveyor stopped, tape a piece of paper on the conveyor directly below the top-mounted scanner.



NOTE: The scanner must be mounted with its face parallel and level with the conveyor surface.

5. Suspend a plumb bob from the 0 (zero) locator on the face of the scanner to the paper placed on the conveyor.

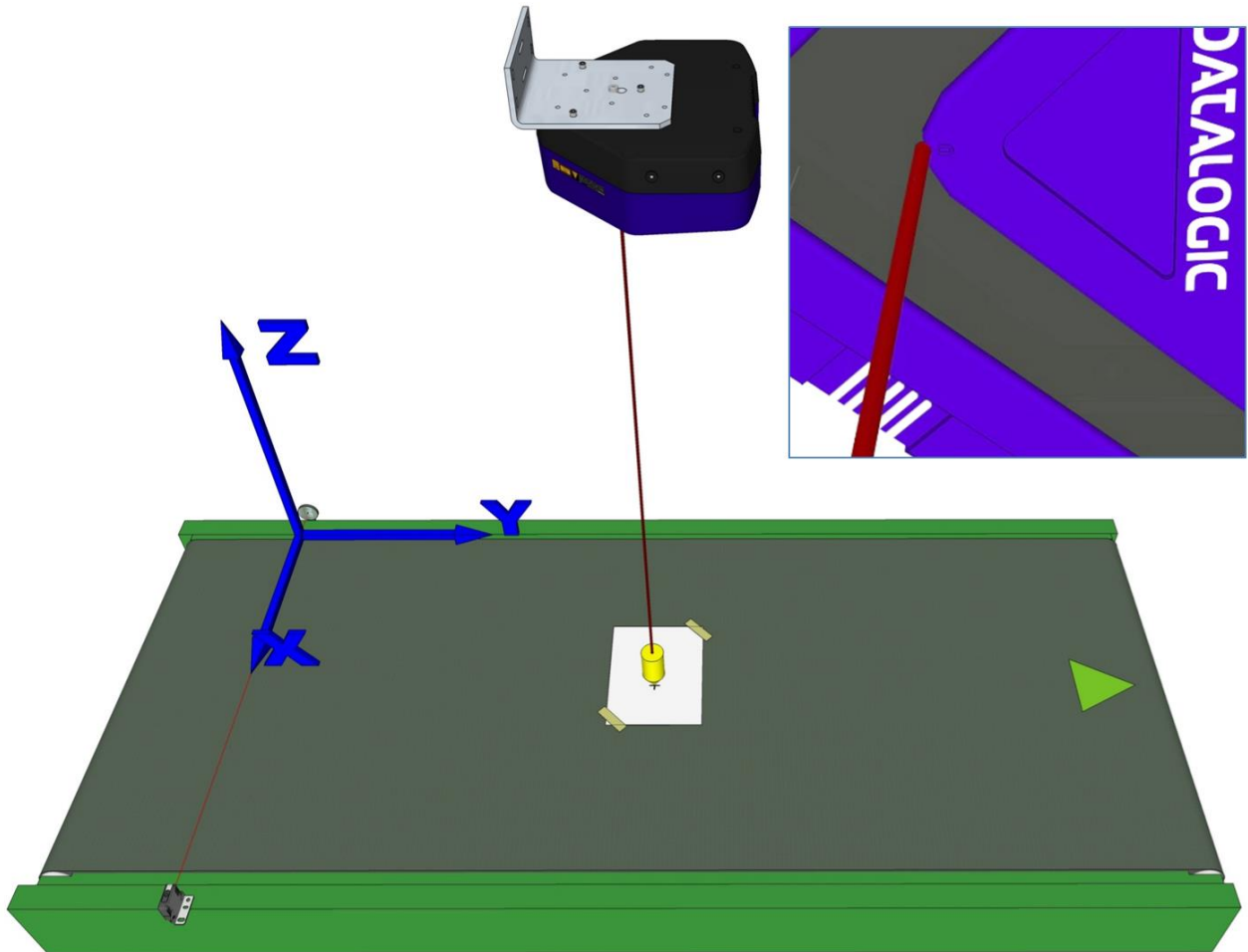

Figure 46: Using a plumb bob to mark scanner location on conveyor

6. Mark the locus of the plumb bob on the paper that is taped to the conveyor surface. For this step, it is helpful to have one person to anchor the plumb bob and a second person to mark its location on the paper.

7. Measure the Y distance from the trigger (photo sensor line) to the locus mark on the paper.

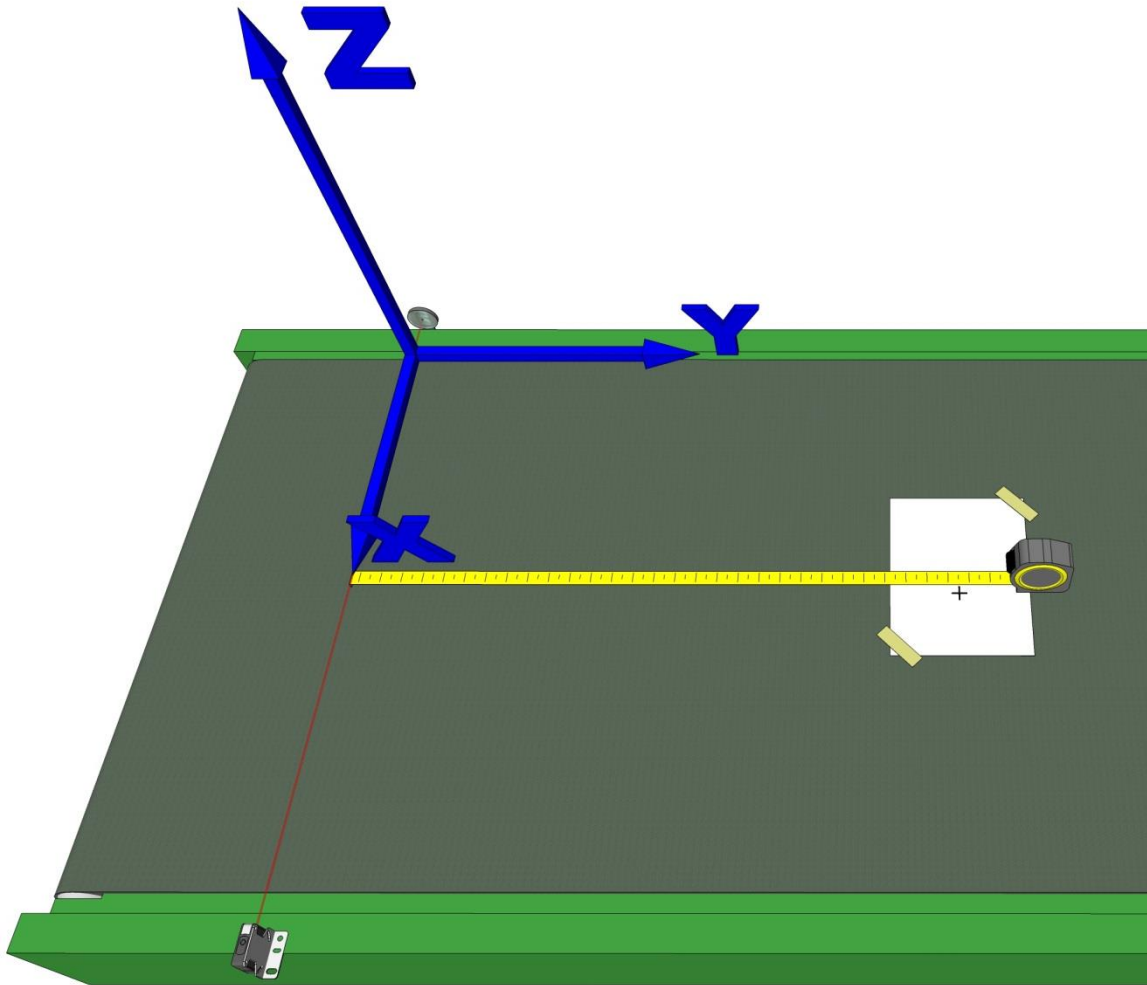

Figure 47: Measuring the Y Offset

8. Enter the Y Offset distance measured in the **Y Offset (Distance from Trigger)** text field.

| | | |
|----------------------------------|------|----|
| Y Offset (Distance from Trigger) | 1211 | mm |
|----------------------------------|------|----|

9. Measure the X Offset from the edge of the conveyor (outside package edge) to the locus mark on the paper.

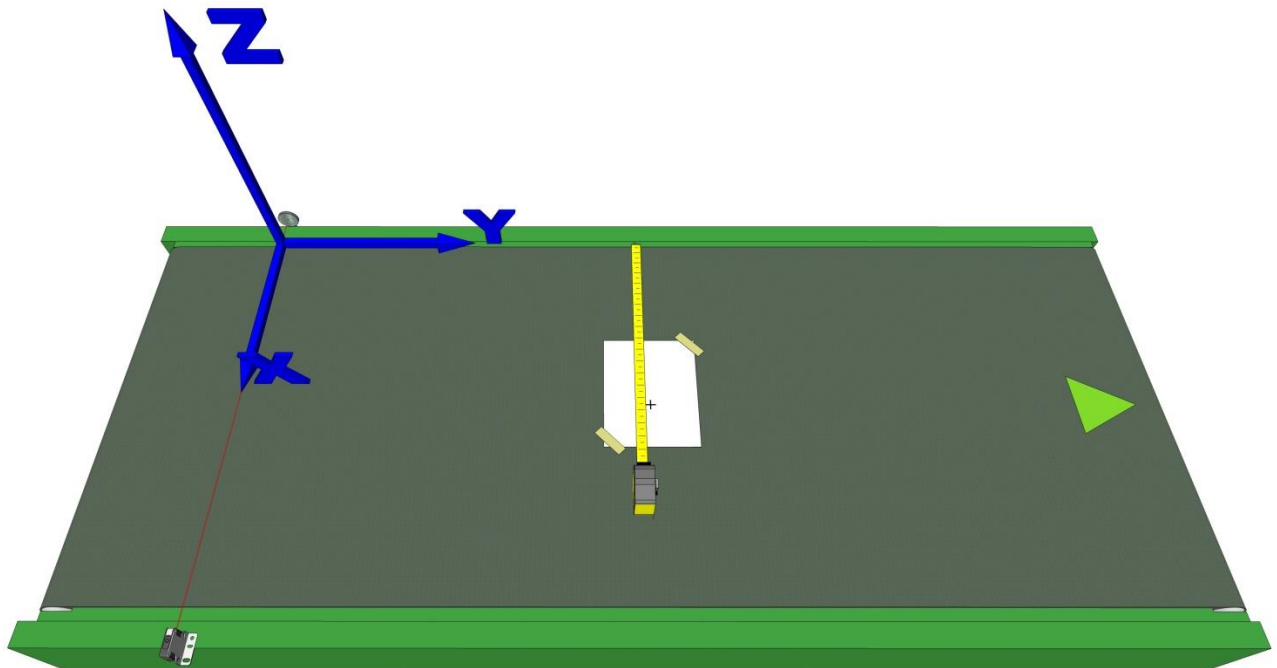

Figure 48: Measuring the X Offset

10. Enter the X Offset distance measured in the **X Offset** text field.

| | | |
|---|-----|----|
| X Offset (Across the Conveyor - OPTIONAL) | 536 | mm |
|---|-----|----|

11. Measure the Z Offset from the 0 (zero) locator on the face of the scanner to the locus mark on the paper.

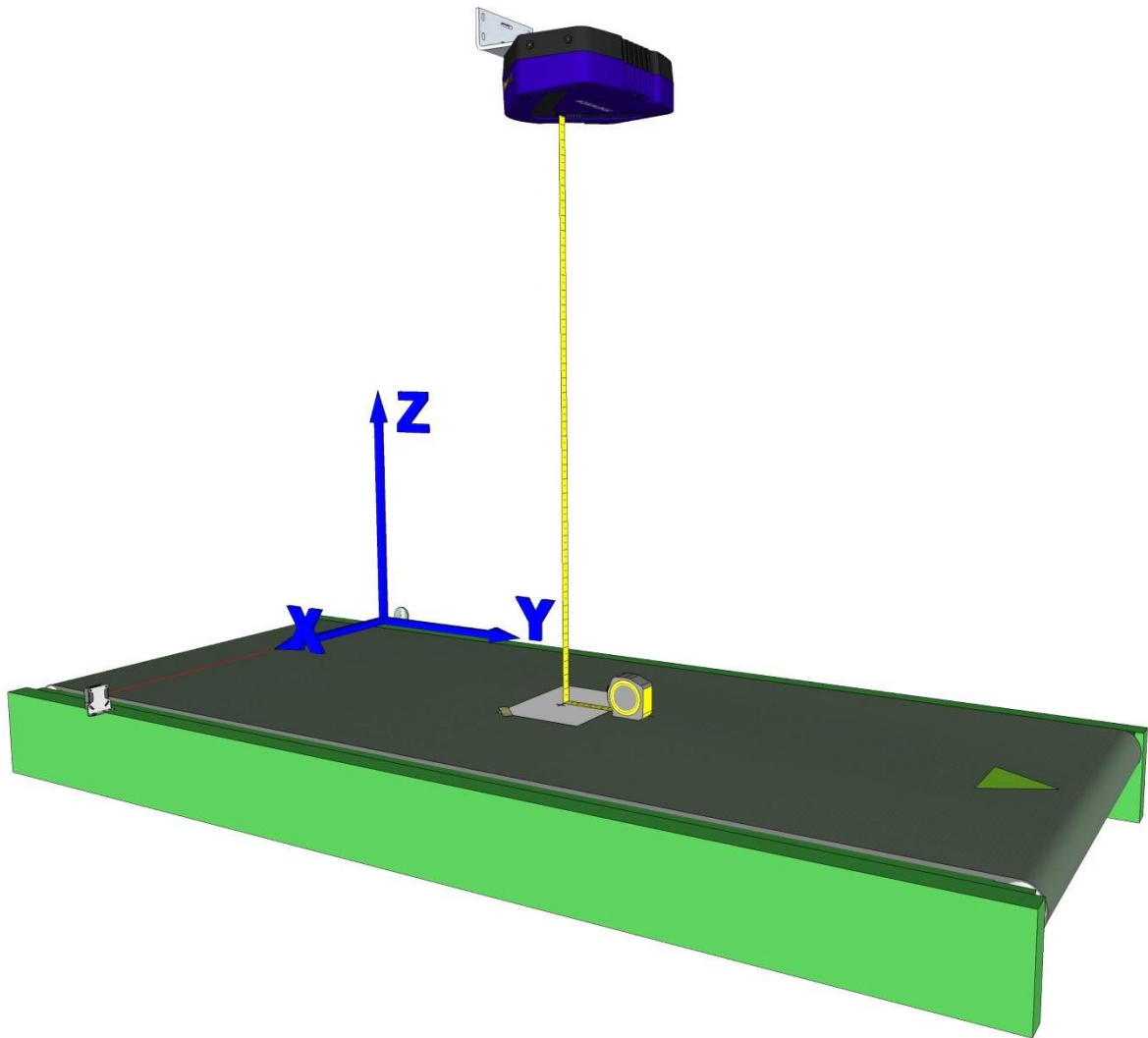

Figure 49: Measuring the Z Offset

12. Enter the Z Offset distance measured in the **Z Offset** text field.

| | | |
|--------------------------------------|------|----|
| Z Offset (Scanner Height - OPTIONAL) | 1490 | mm |
|--------------------------------------|------|----|

13. Click **Update** to save the changes.

5.6.1 Built-In Calibration Static Test

1. Place a test label in the center of a box, and place the test box in the scan line as shown below.

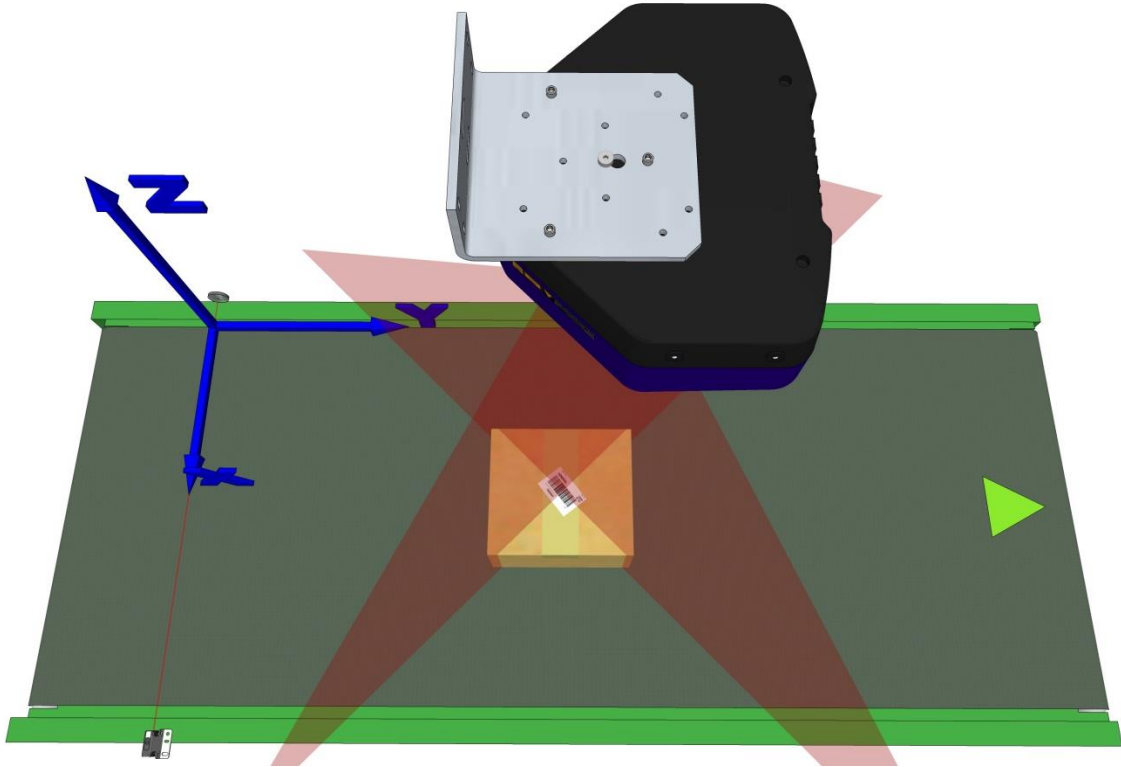
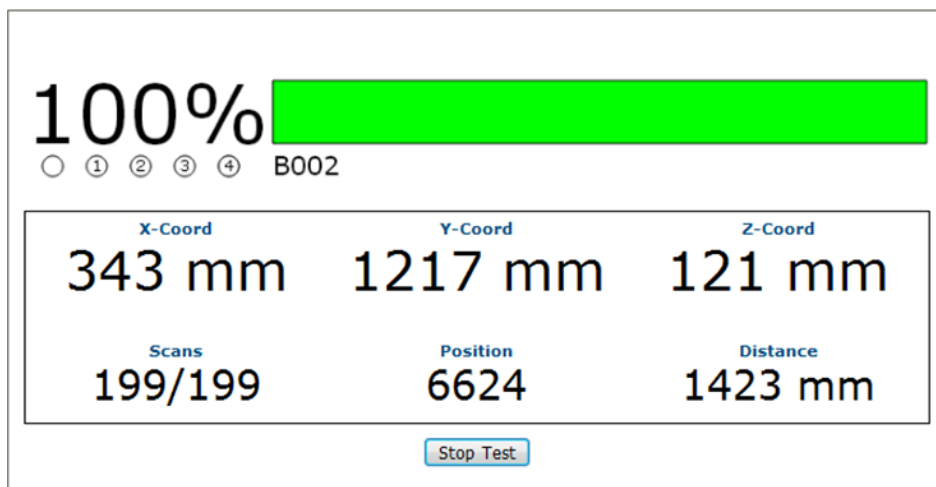

Figure 50: Test box and label placed in laser line

2. In **e-Genius**, navigate to **Diagnostics | Read Test**. The Read Test window opens.
3. Click **Start Test**. The resulting Y-Coordinate returned should be close to the Y Offset measured in the **Alternate Built-In Calibration for Top-Mount** procedure.



5.6.2 Built-In Calibration Dynamic Test

1. Turn on the conveyor.
2. In **e-Genius**, navigate to **Diagnostics | Monitor**. The **Monitor** window opens.
3. Place a test label in the center of a box, and run the box under the scanner.
4. The scanner should read the label and the results will be displayed on the **Monitor** window.

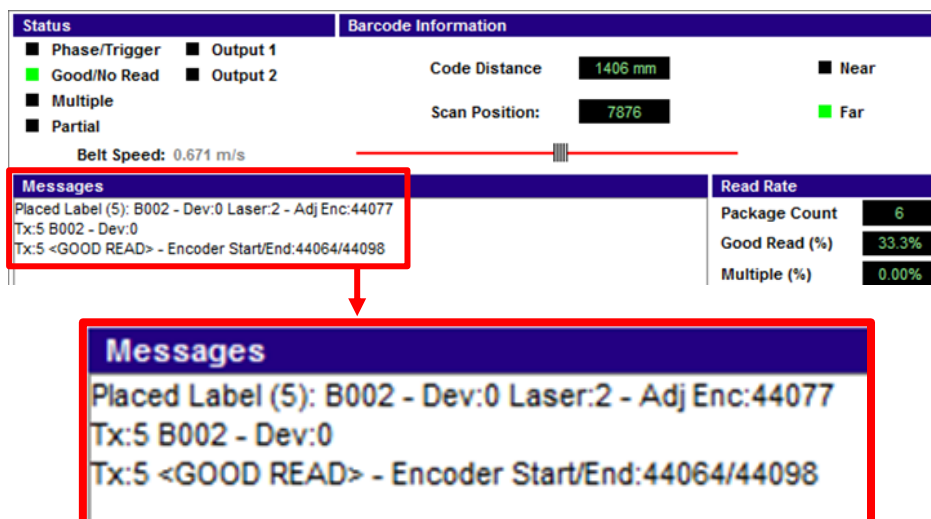

The **Adj Enc** (Adjusted Encoder) value indicates the encoder count at which the label was read. **Encoder Start/End** indicates the encoder values at the start and end of the test box.

The **Adj Enc** value must fall between the start and end values, indicating that the label is on the box. If this is the case, the message states “**Placed Label.**”

If the **Adj Enc** value falls outside the start and end values, the message states “**Unplace Label.**”



To Verify Label Placement:

1. Using a short test box, place the test label on the leading edge of the top of the box, and run the box under the scanner. If the measurements were correct, the monitor window message should show "Placed Label."

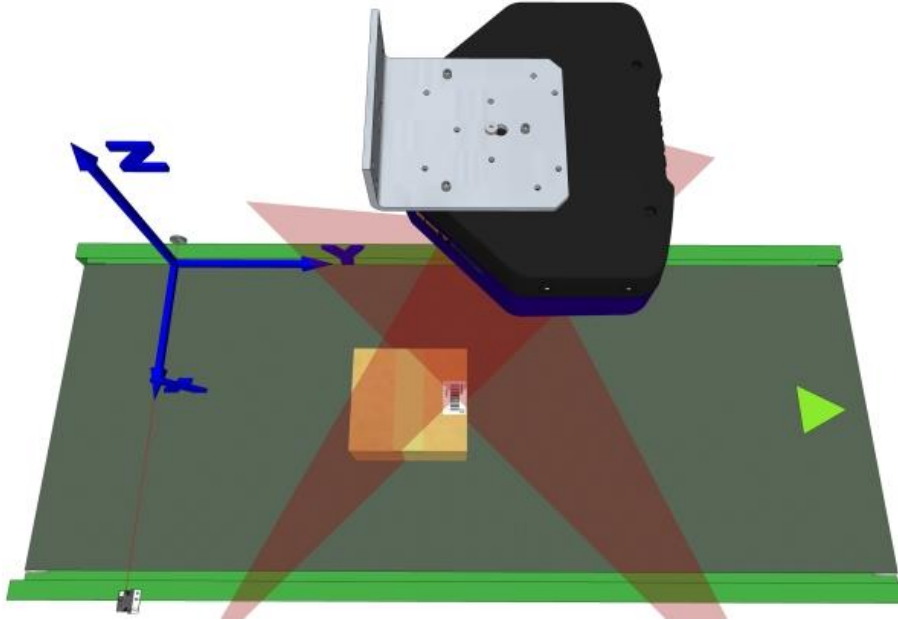

Figure 51: Short box with test label placed on the leading edge

2. Repeat the test three more times with a label on the trailing edge of the same box and on the leading and trailing edges of a tall system box. In each case, the monitor window message should show "Placed Label."

5.7 PACKTRACK™

PackTrack is a patented operating mode for Datalogic Omni-Directional Reading Stations used to read and correctly assign codes read on different packs when placed in the scanner Reading Area at the same time.

In fact, in the following example, the codes of two or more consecutive packs are found at the same time in the scanner reading area. Therefore, the condition occurs where, in the sequence of the two packs, the code of the second pack is read first, just before the code of the previous pack. A system without **PackTrack** would assign the code of the second pack to the first pack and vice versa, thus causing a gross error in sortation.

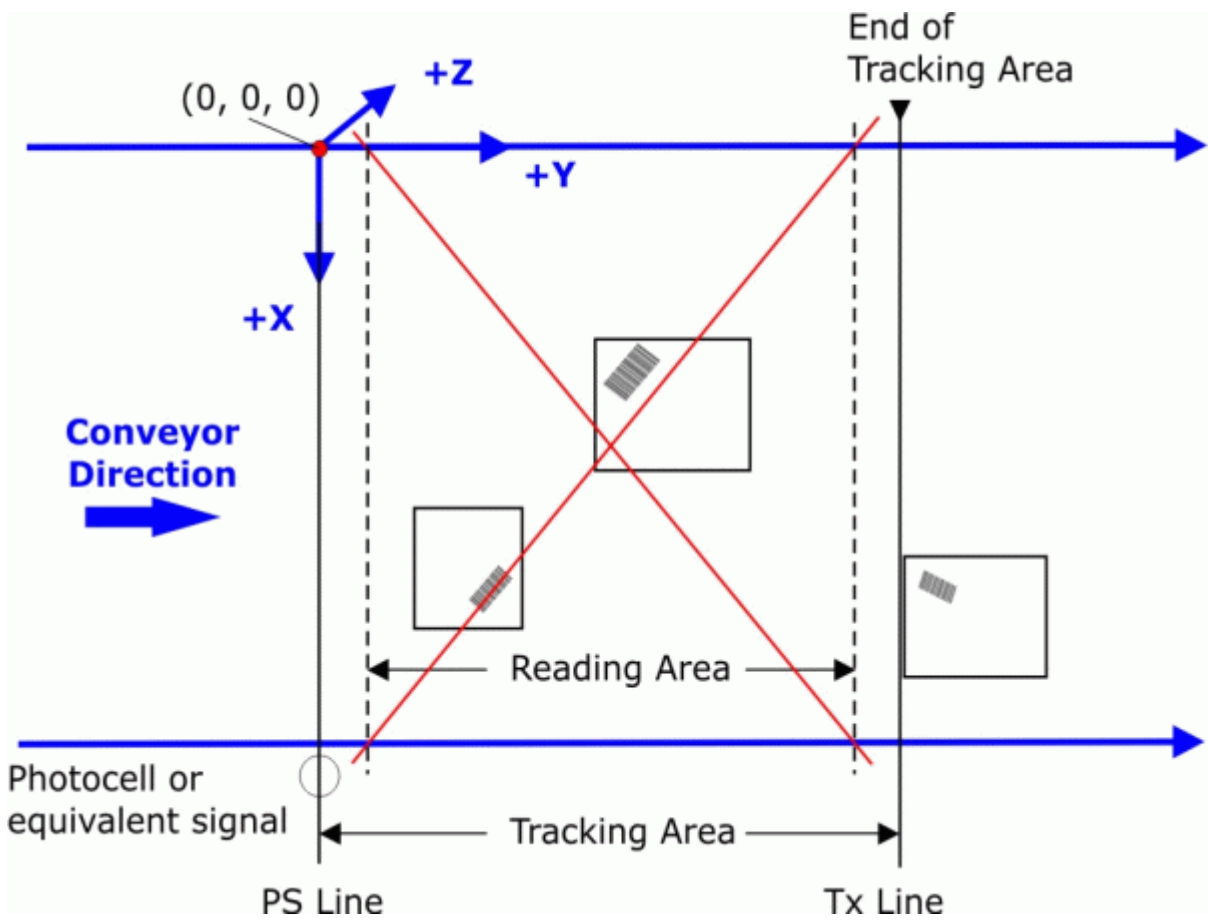

Figure 52: Tracking Problem



NOTE: Tracking starts 10 cm before and stops 10 cm after the Reading Area in order to ensure the barcode is assigned to the correct package.

PackTrack uses a right-handed reference system where the **X** axis coincides with the Photoelectric Sensor line, the **Y** axis coincides with the conveyor direction, and the **Z** axis is oriented upwards from the conveyor (see figure below). The arrows point in the positive direction. The coordinate point of origin (0,0,0) is on the left edge of the conveyor as illustrated.

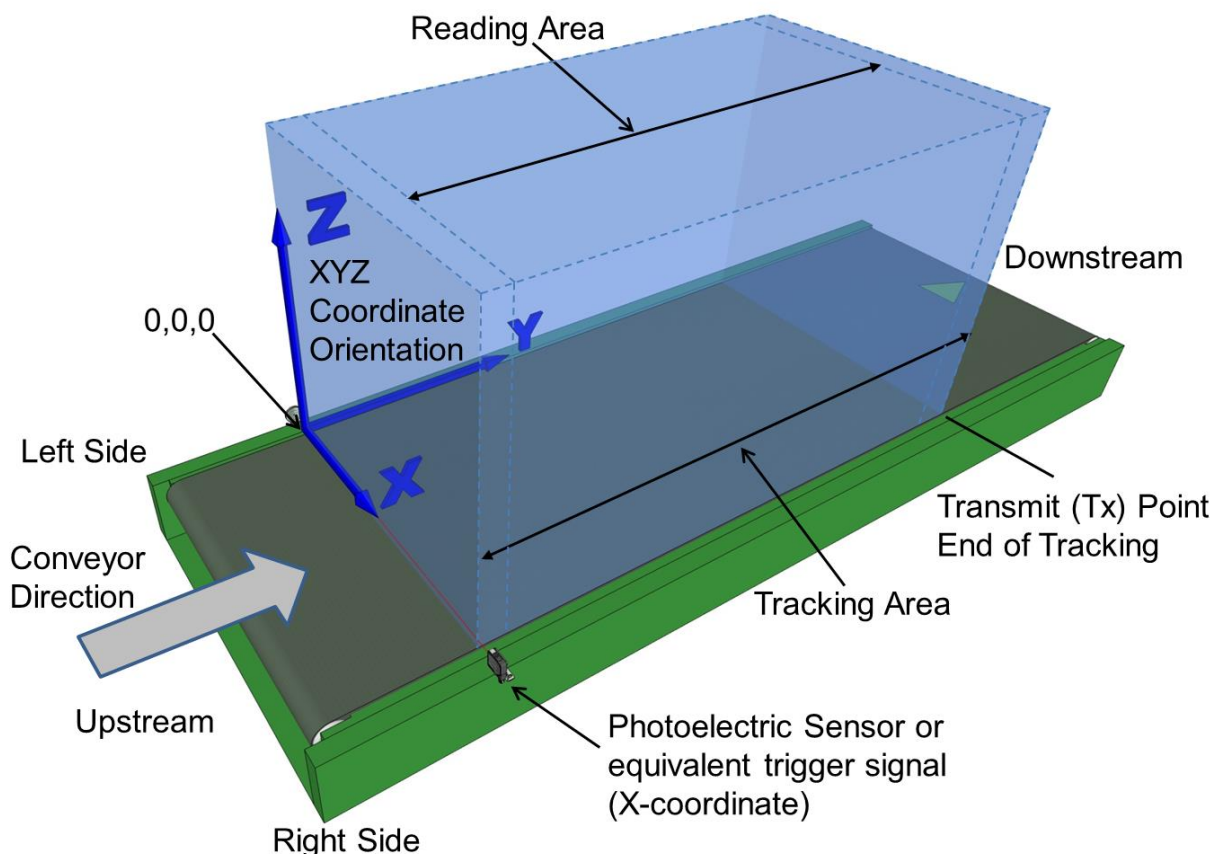

Figure 53: Tracking Area

This coordinate system is absolute for the reading station, i.e. valid for all the scanners independently from their position or orientation with respect to the conveyor. For this reason, after the **PackTrack** configuration (and calibration) has been correctly performed, when a barcode is under the beam to be read by the scanners, its position is defined by the coordinates of its central point, independently from which scanner is reading it.

Step-by-step procedures for calibrating [Top-Mounted](#) and [Side-Mounted](#) barcode scanners are described below.

5.7.1 Using the PackTrack Wizard

Before you begin calibration:

1. In **Modify Settings/Global Settings/Barcode Settings**, select and configure a system barcode.
2. In **Modify Settings/Global Settings /Barcode Configuration**, create a **Global No Read** message you can easily recognize, such as **NO READ**.
3. In **Modify Settings/Global Settings /Operating Mode**, select **PackTrack** as your **Operating Mode Selection**. Make sure the mode settings and encoder settings match your system parameters.
4. Navigate to **Diagnostics/Read Test**.
5. Place a system barcode in the scan line of the barcode scanner.

- Click **Start Test**. The scanner should successfully read the barcode. If it doesn't, read successfully or registers a low read rate, check the system specifications for mounting distance and barcode specifications. Then make adjustments as necessary and repeat the test. If the scanner continues to have problems reading the barcode, contact Datalogic (www.datalogic.com).

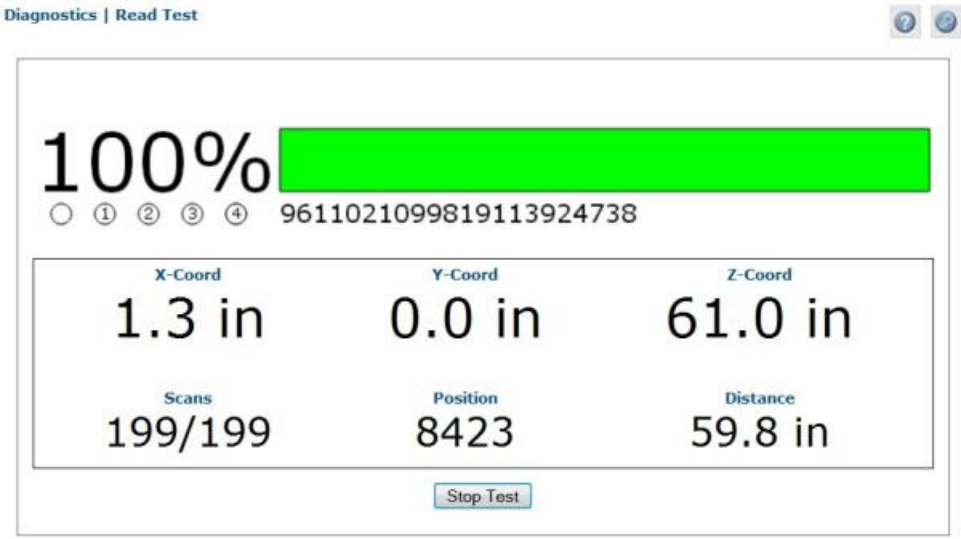

NOTE: A read test tool has now been added to the bottom section of the **PackTrack Calibration Wizard**, which can supply the read rate and XYZ coordinates.

- Repeat the test for both legs (each laser line of the X-pattern) of a DX8210 scanner.
- Click **Stop Test**.

To access the PackTrack Wizard:

1. In the tree menu under **Modify Settings**, navigate to **Device Settings | Mounting**. The **Mounting** window opens.
2. Select **PackTrack Calibration** from the **Calibration Method** drop-down list.

Scanner Mounting

Leg1

Calibration Method: PackTrack Calibration

PackTrack Calibration Wizard

Launch Wizard

Calibration Adjustment

Y Adjustment: 0 mm

PackTrack Calibration Coefficients

| | |
|--------------------|----------|
| Calibration Item 1 | 0.000000 |
| Calibration Item 2 | 0.000000 |
| Calibration Item 3 | 0.000000 |
| Calibration Item 4 | 0.000000 |
| Calibration Item 5 | 0.000000 |
| Calibration Item 6 | 0.000000 |
| Calibration Item 7 | 0.000000 |
| Calibration Item 8 | 0.000000 |
| Calibration Item 9 | 0.000000 |

Update All Reset All Reset Page

3. Select **Leg1** from the drop-down list at the top of the window.
4. Click **Launch Wizard**. The **PackTrack Calibration** wizard window opens.

PackTrack Calibration

3 - TableXScanner Leg1

Initialized (leg=1)

Initialize Display 1 Display 2 Display 3

| X-Coord (mm) | Y-Coord (mm) | Z-Coord (mm) | |
|--------------|--------------|--------------|-------------|
| | | | Calibrate 1 |
| | | | Calibrate 2 |
| | | | Calibrate 3 |

Compute Result

Update All

| Read % | Measured X-Coord (mm) | Measured Y-Coord (mm) | Measured Z-Coord (mm) |
|--------|-----------------------|-----------------------|-----------------------|
| 0% | 0 | 0 | 0 |

Start Test

The **PackTrack Calibration Wizard** asks you to physically measure and enter barcode coordinates for the extremes of your barcode scanning system. You will measure and enter XYZ coordinates for barcodes in three different locations along each of the DX8210's laser line (legs). One leg of a **top-mounted** and **side-mounted** DX8210 scanner is shown in the illustrations below.

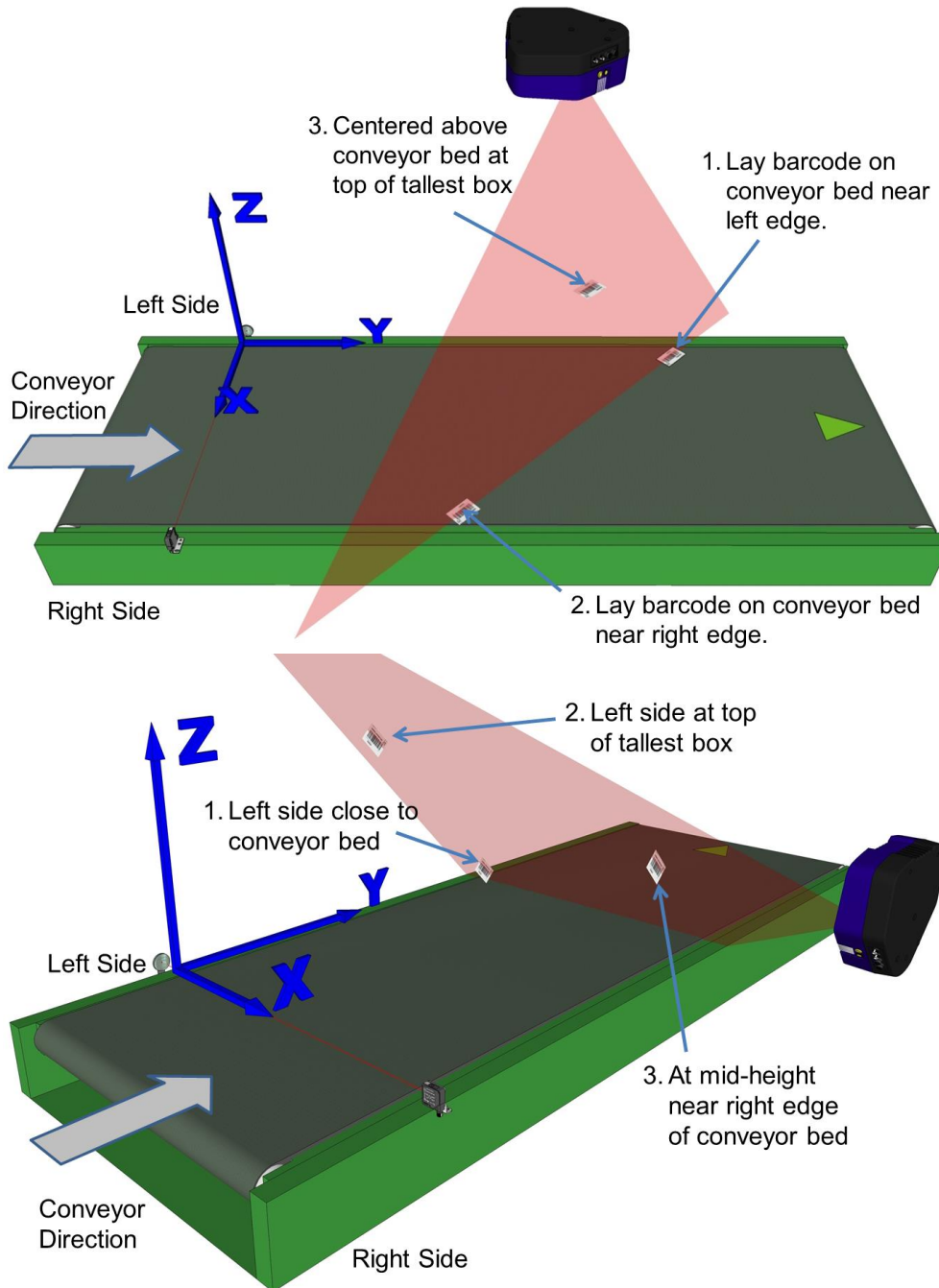

Figure 54: Barcode locations for Top Mount and Side Mount barcode scanners



NOTE: A barcode test chart is included in the box with each scanner, and a code from the chart can be used for the PackTrack calibration. You may also use a standard barcode from your specific application, however, test the code to make sure the scanner reads it at 100% using **Diagnostics | Read Test** in **e-Genius** (see 4.7.2).

5.7.2 Top-Mounted Barcode Scanner Calibration Using PackTrack



NOTE: It is not possible to illustrate every possible installation angle and scanner mounting position in this manual. Use the following steps as a general guide to calibrating each system scanner using barcodes in three positions. You will need to make adjustments to the label/box position based on your situation. It is, however, important to note the fixed XYZ coordinates of the conveyor.

With the belt stopped, measure and enter the barcode XYZ coordinate data for each scanner as follows:

1. Make sure that the intended scanner (in a multi-head system) and **Leg1** have been selected from the drop-down lists at the top of the wizard window.
2. Lay a system barcode on the conveyor bed in the laser line close to the left edge (X=0 edge) of the conveyor bed. See illustration below.

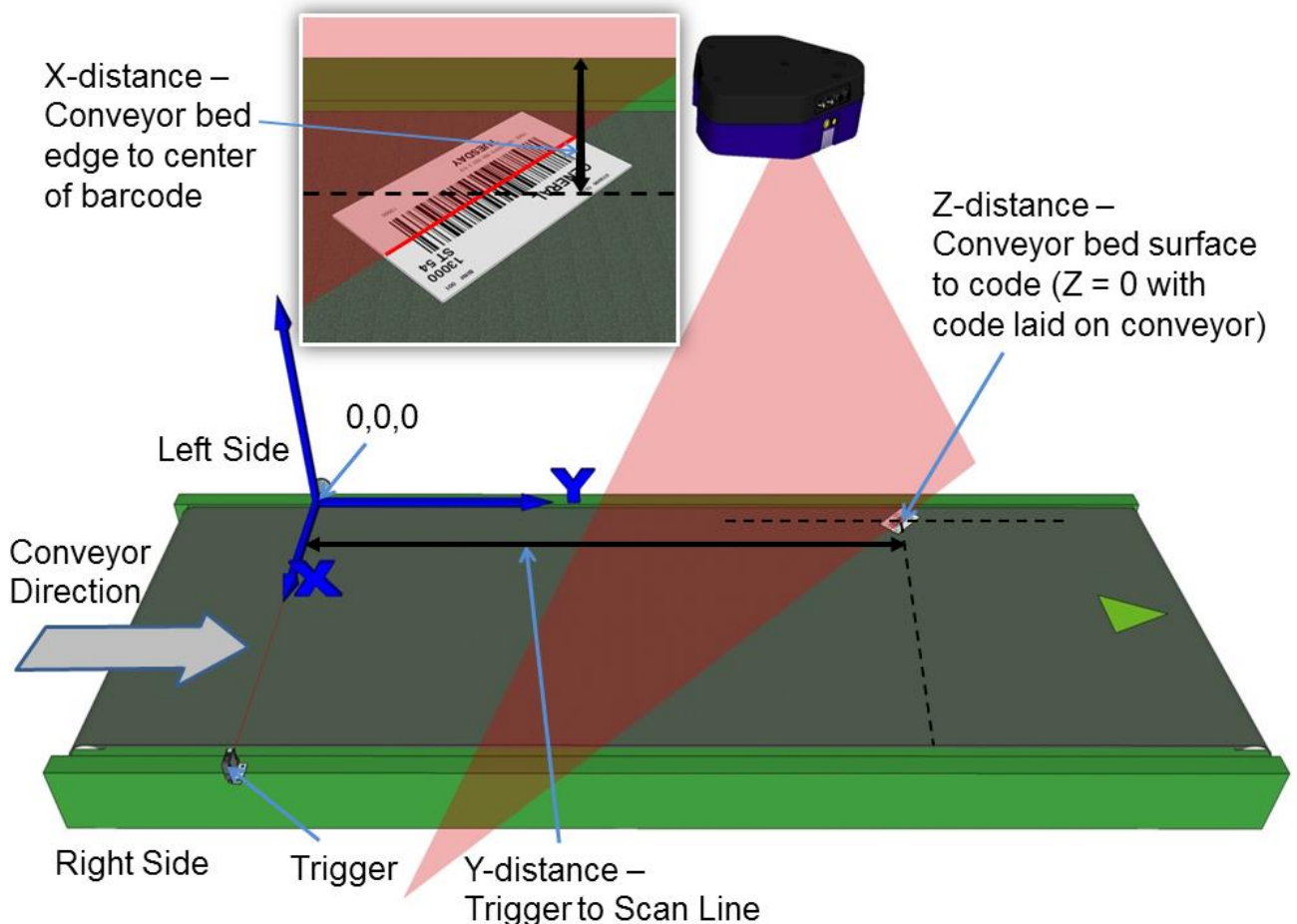

Figure 55: Top-read 1st barcode placement

3. Measure the distance for **X** from the edge of the conveyor bed to the center of the barcode, and enter that distance in the first box under **X-Coord (mm)** in the **PackTrack Calibration Wizard**.

Your measurements will likely differ from those shown below.

| X-Coord (mm) | Y-Coord (mm) | Z-Coord (mm) |
|--------------|--------------|--------------|
| 210 | | |
| | | |
| | | |

4. Measure the distance for **Y** from the trigger (PS line) to the barcode scanner's laser line on the barcode, and enter that distance in the first box under **Y-Coord (mm)**.



NOTE: To make it easier to measure the Y-Coordinate, place a box along the photoelectric sensor laser line (Trigger). Then the end of the tape measure or ruler can be placed against the edge of the box. See below.

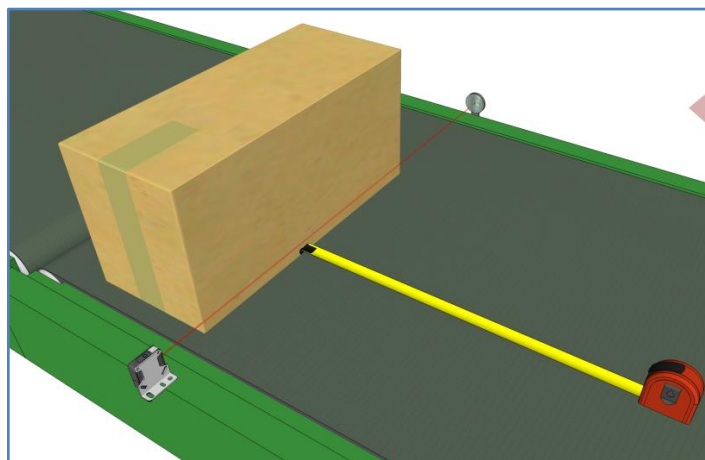

Figure 56: Measuring from trigger

Your measurements will likely differ from those shown below.

| X-Coord (mm) | Y-Coord (mm) | Z-Coord (mm) |
|--------------|--------------|--------------|
| 210 | 1080 | |
| | | |
| | | |

5. Measure the distance for **Z** from the conveyor bed to the barcode, and enter that distance in the first box under **Z-Coord (mm)**. Since the barcode is directly on the conveyor bed, the value should be "0."

Your measurements will likely differ from those shown below.

| X-Coord (mm) | Y-Coord (mm) | Z-Coord (mm) |
|--------------|--------------|--------------|
| 210 | 1080 | 0 |
| | | |
| | | |

6. Click **Calibrate 1**. PackTrack data is displayed for the first code.

```
Code 1 - X/Y/Z:      210.000000 / 1080.000000 / 0.000000
(Ieg 1)  Dist/Angle: 1963.987500 / -0.325454
```

Initialize Display 1 Display 2 Display 3

| X-Coord (mm) | Y-Coord (mm) | Z-Coord (mm) |
|-----------------|-----------------|-----------------|
| 210 | 1080 | 0 |
| | | |
| | | |

Calibrate 1
Calibrate 2
Calibrate 3

Compute Result

Update

7. Next, place a system barcode on the conveyor bed in the laser line close to the right edge of the conveyor bed. See *illustration below*.

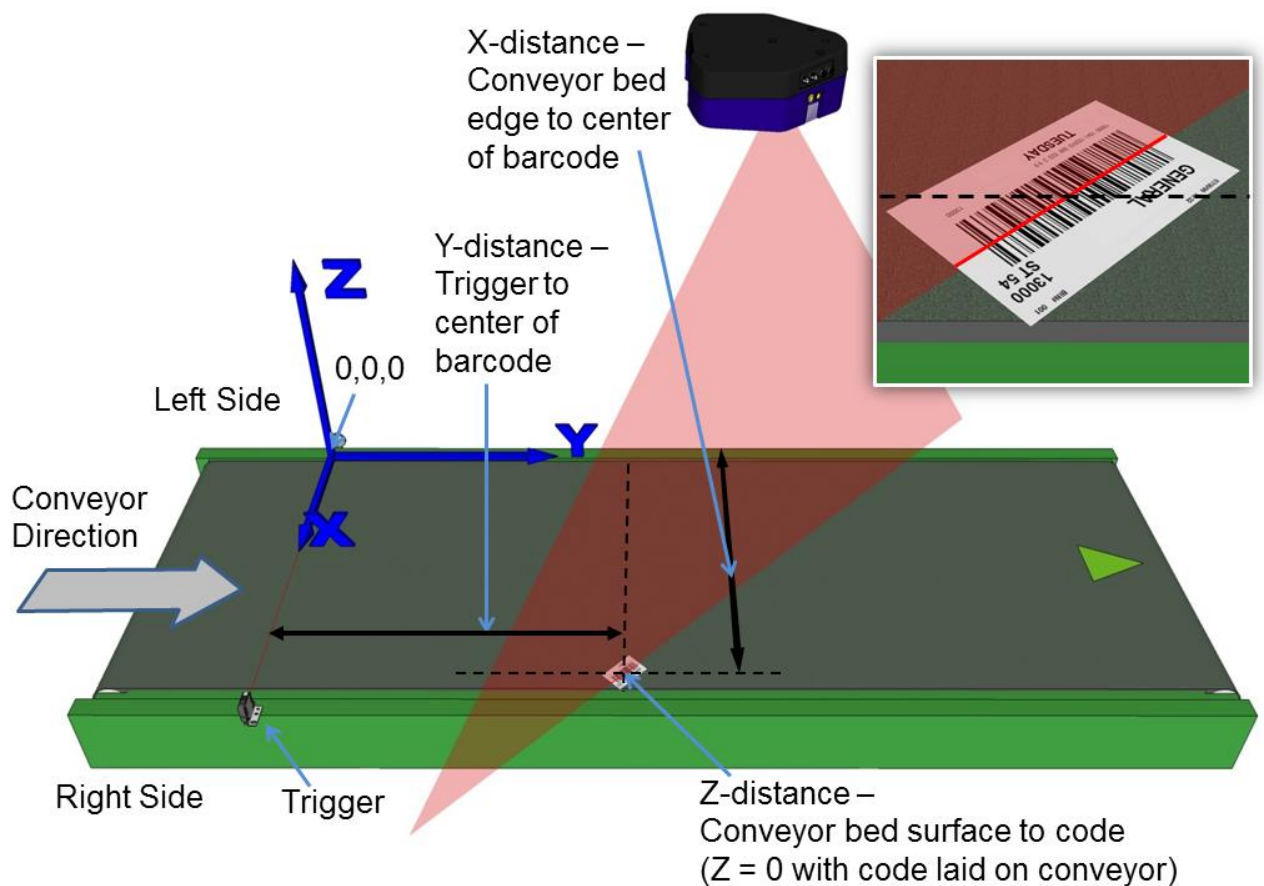

Figure 57: Top-read 2nd barcode placement

- Measure the distance for **X** from the left edge of the conveyor bed to the center of the barcode, and enter that distance in the first box under **X-Coord (mm)**.

Your measurements will likely differ from those shown below.

| X-Coord (mm) | Y-Coord (mm) | Z-Coord (mm) |
|--------------|--------------|--------------|
| 210 | 1080 | 0 |
| 1130 | | |
| | | |

- Measure the distance for **Y** from the trigger (PS line) to the barcode scanner's laser line on the barcode, and enter that distance in the first box under **Y-Coord (mm)**.

Your measurements will likely differ from those shown below.

| X-Coord (mm) | Y-Coord (mm) | Z-Coord (mm) |
|--------------|--------------|--------------|
| 210 | 1080 | 0 |
| 1130 | 218 | |
| | | |

- Measure the distance for **Z** from the conveyor bed to the barcode, and enter that distance in the first box under **Z-Coord (mm)**. Since the barcode is directly on the conveyor bed, the value should be "0."

Your measurements will likely differ from those shown below.

| X-Coord (mm) | Y-Coord (mm) | Z-Coord (mm) |
|--------------|--------------|--------------|
| 210 | 1080 | 0 |
| 1130 | 218 | 0 |
| | | |

- Click **Calibrate 2**. PackTrack data is displayed for the second code.

```
Code 2 - X/Y/Z:      1130.000000 / 218.000000 / 0.000000
(Leg 1)  Dist/Angle: 1924.300000 / 0.319797
```

| X-Coord (mm) | Y-Coord (mm) | Z-Coord (mm) |
|--------------|--------------|--------------|
| 210 | 1080 | 0 |
| 1130 | 218 | 0 |
| | | |

12. Finally, place a system barcode on the back right corner of the tallest system box, as shown in the illustration below.

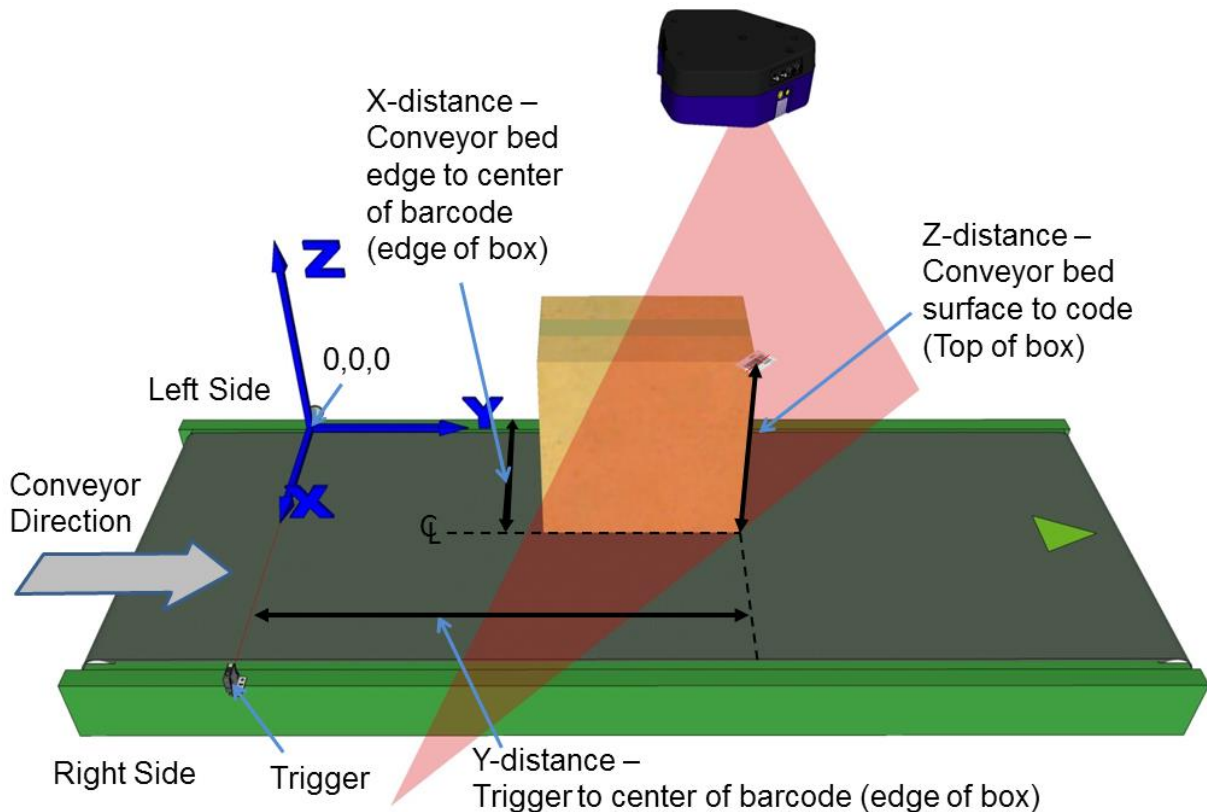

Figure 58: Top-read 3rd barcode placement

13. Measure the distance for **X** from the left edge of the conveyor bed to the center of the barcode (edge of box), and enter that distance in the first box under **X-Coord (mm)**.

Your measurements will likely differ from those shown below.

| X-Coord (mm) | Y-Coord (mm) | Z-Coord (mm) |
|--------------|--------------|--------------|
| 210 | 1080 | 0 |
| 1130 | 218 | 0 |
| 502 | | |

14. Measure the distance for **Y** from the trigger (PS line) to the barcode scanner's laser line on the barcode (back edge of box), and enter that distance in the first box under **Y-Coord (mm)**.

Your measurements will likely differ from those shown below.

| X-Coord (mm) | Y-Coord (mm) | Z-Coord (mm) |
|--------------|--------------|--------------|
| 210 | 1080 | 0 |
| 1130 | 218 | 0 |
| 502 | 650 | |

15. Measure the distance for **Z** from the conveyor bed to the barcode, and enter that distance

in the first box under **Z-Coord (mm)**.

Your measurements will likely differ from those shown below.

| X-Coord (mm) | Y-Coord (mm) | Z-Coord (mm) |
|--------------|--------------|--------------|
| 210 | 1080 | 0 |
| 1130 | 218 | 0 |
| 502 | 650 | 910 |

16. Click **Calibrate 3**. PackTrack data is displayed for the third code.

```
Code 3 - X/Y/Z:      502.000000 / 650.000000 / 910.000000
(Leg 1)  Dist/Angle: 879.725000 / -0.159012
```

| X-Coord (mm) | Y-Coord (mm) | Z-Coord (mm) |
|--------------|--------------|--------------|
| 210 | 1080 | 0 |
| 1130 | 218 | 0 |
| 502 | 650 | 910 |

17. Click **Compute Results**. The results are displayed at the top of the **PackTrack Calibration** window.

0 - Top-X
Leg1

```
Result:  0.748256  0.074221 541.760010
         -0.696657  0.090266 474.549408
         -0.025756 -0.929780 1714.043823
```

| X-Coord (mm) | Y-Coord (mm) | Z-Coord (mm) |
|--------------|--------------|--------------|
| 210 | 1080 | 0 |
| 1130 | 218 | 0 |
| 502 | 650 | 910 |

18. Click **Update**. "Update Successful" should be displayed in the **PackTrack Calibration** window.

19. Next, select **Leg2** from the drop-down list at the top of the wizard window. Leg 2 laser comes on.
20. Rotate the tall system box 90-degrees and make sure the laser (leg 2) is centered on the barcode on its top corner, as shown in the illustration below.

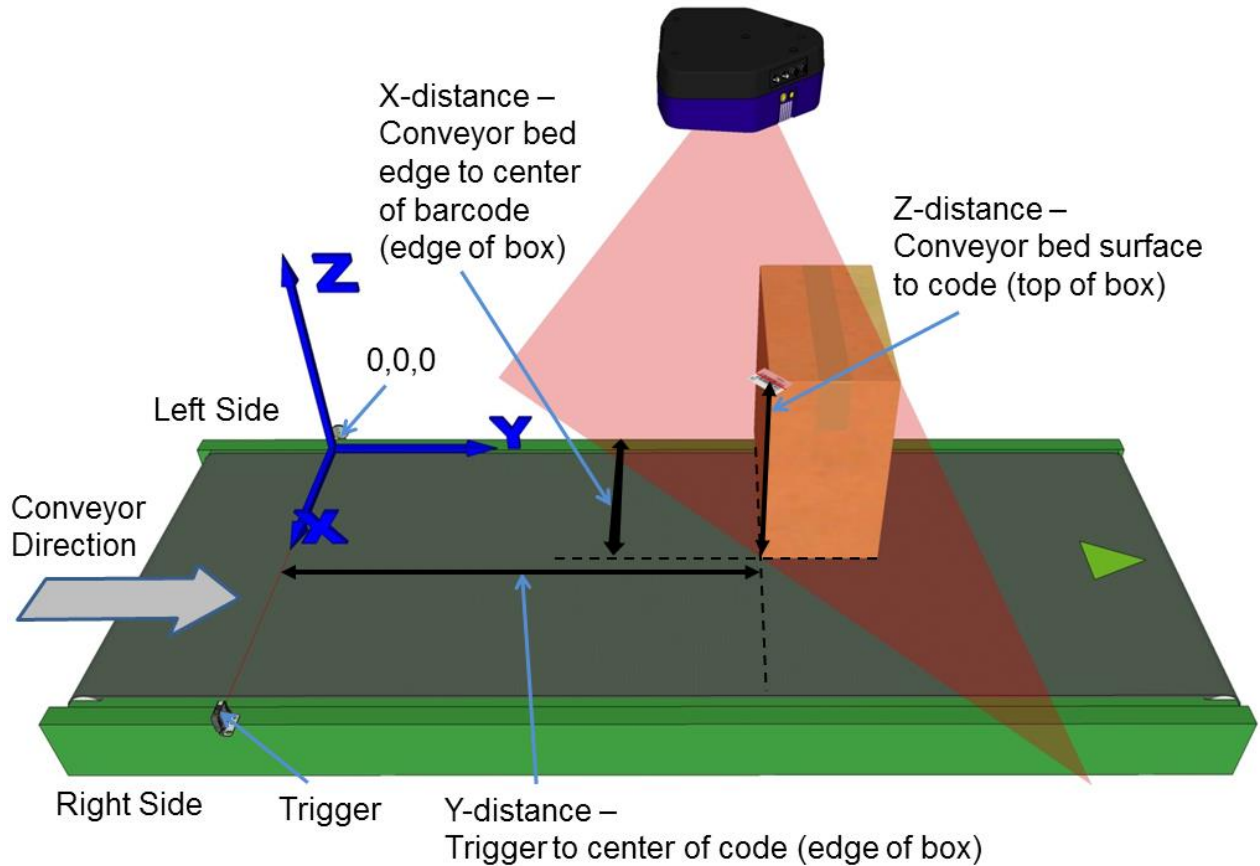

Figure 59: Top-read leg 2- 1st barcode placement

21. Measure the distance for **X** from the left edge of the conveyor bed to the center of the barcode (edge of box), and enter that distance in the first box under **X-Coord (mm)**.

Your measurements will likely differ from those shown below.

| X-Coord (mm) | Y-Coord (mm) | Z-Coord (mm) |
|--------------|--------------|--------------|
| 705 | | |
| | | |
| | | |

22. Measure the distance for **Y** from the trigger (PS line) to the barcode scanner's laser line on the barcode (edge of box), and enter that distance in the first box under **Y-Coord (mm)**.

Your measurements will likely differ from those shown below.

| X-Coord (mm) | Y-Coord (mm) | Z-Coord (mm) |
|--------------|--------------|--------------|
| 705 | 623 | |
| | | |
| | | |

23. Measure the distance for **Z** from the conveyor bed to the barcode, and enter that distance in the first box under **Z-Coord (mm)**.

Your measurements will likely differ from those shown below.

| X-Coord (mm) | Y-Coord (mm) | Z-Coord (mm) |
|--------------|--------------|--------------|
| 705 | 623 | 910 |
| | | |
| | | |

24. Click **Calibrate 1**. PackTrack data is displayed for the first code.

```
Code 1 - X/Y/Z:      705.000000 / 623.000000 / 910.000000
(Ieg 2)  Dist/Angle: 860.675000 / 0.076654
```

| X-Coord (mm) | Y-Coord (mm) | Z-Coord (mm) |
|--------------|--------------|--------------|
| 705 | 623 | 910 |
| | | |
| | | |

25. Place a system barcode on the conveyor bed in the laser line close to the left edge (X=0 edge) of the conveyor bed. See illustration below.

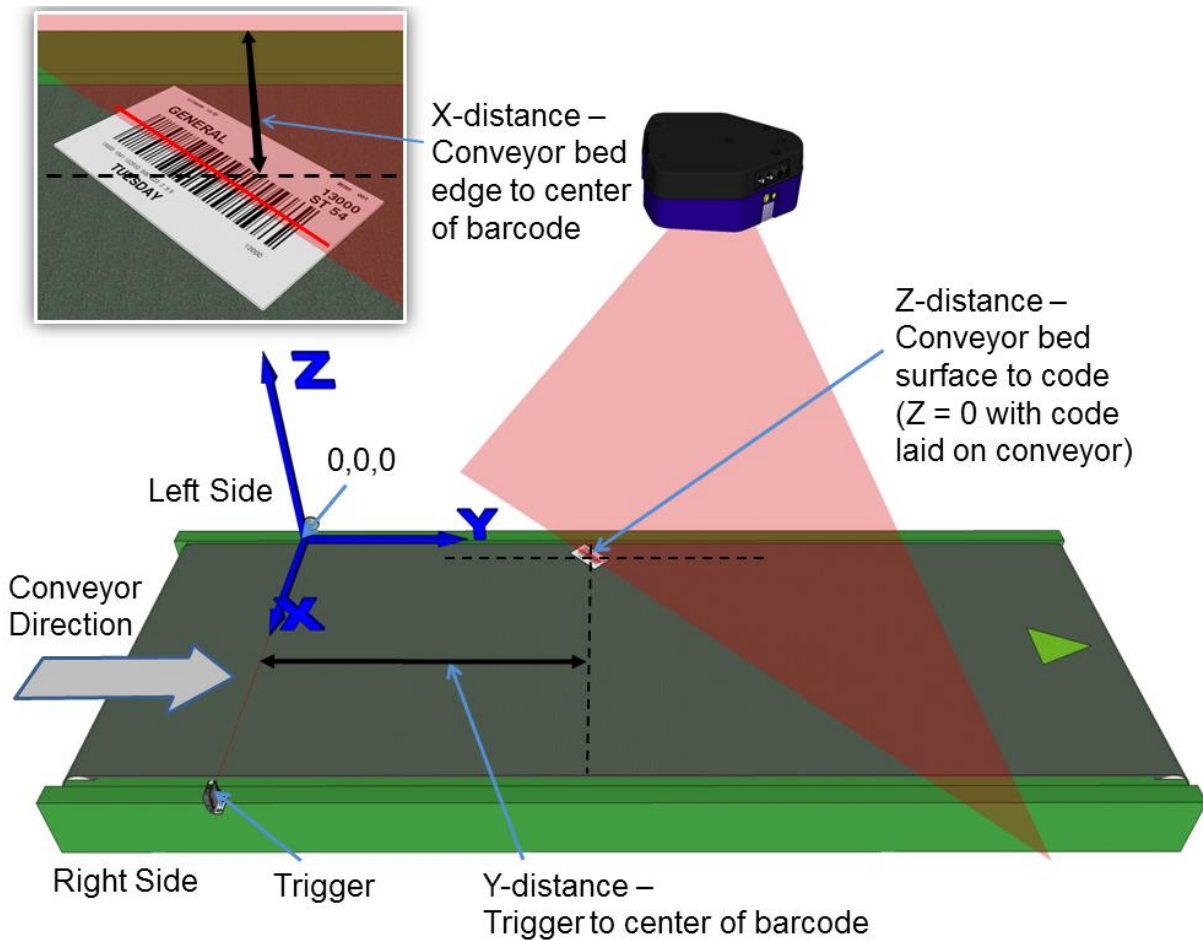

Figure 60: Top-read leg 2- 2nd barcode placement

26. Measure the distance for **X** from the edge of the conveyor bed to the center of the barcode, and enter that distance in the first box under **X-Coord (mm)** in the **PackTrack Calibration Wizard**.

Your measurements will likely differ from those shown below.

| X-Coord (mm) | Y-Coord (mm) | Z-Coord (mm) |
|--------------|--------------|--------------|
| 705 | 623 | 910 |
| 158 | | |
| | | |

27. Measure the distance for **Y** from the trigger (PS line) to the barcode scanner's laser line on the barcode, and enter that distance in the first box under **Y-Coord (mm)**.

Your measurements will likely differ from those shown below.

| X-Coord (mm) | Y-Coord (mm) | Z-Coord (mm) |
|--------------|--------------|--------------|
| 705 | 623 | 910 |
| 158 | 202 | |
| | | |

28. Measure the distance for **Z** from the conveyor bed to the barcode, and enter that distance in the first box under **Z-Coord (mm)**. Since the barcode is directly on the conveyor bed, the value should be "0."

Your measurements will likely differ from those shown below.

| X-Coord (mm) | Y-Coord (mm) | Z-Coord (mm) |
|--------------|--------------|--------------|
| 705 | 623 | 910 |
| 158 | 202 | 0 |
| | | |

29. Click **Calibrate 2**. PackTrack data is displayed for the first code.

0 - Top-X Leg2

```
Code 2 - X/Y/Z:      158.000000 / 202.000000 / 0.000000
(Leg 2)  Dist/Angle: 1903.662500 / -0.339835
```

Initialize Display 1 Display 2 Display 3

| X-Coord (mm) | Y-Coord (mm) | Z-Coord (mm) |
|--------------|--------------|--------------|
| 705 | 623 | 910 |
| 158 | 202 | 0 |
| | | |

Calibrate 1
Calibrate 2
 Calibrate 3

Compute Result
 Update

30. Next, place a system barcode on the conveyor bed in the laser line close to the right edge of the conveyor bed. See illustration below.

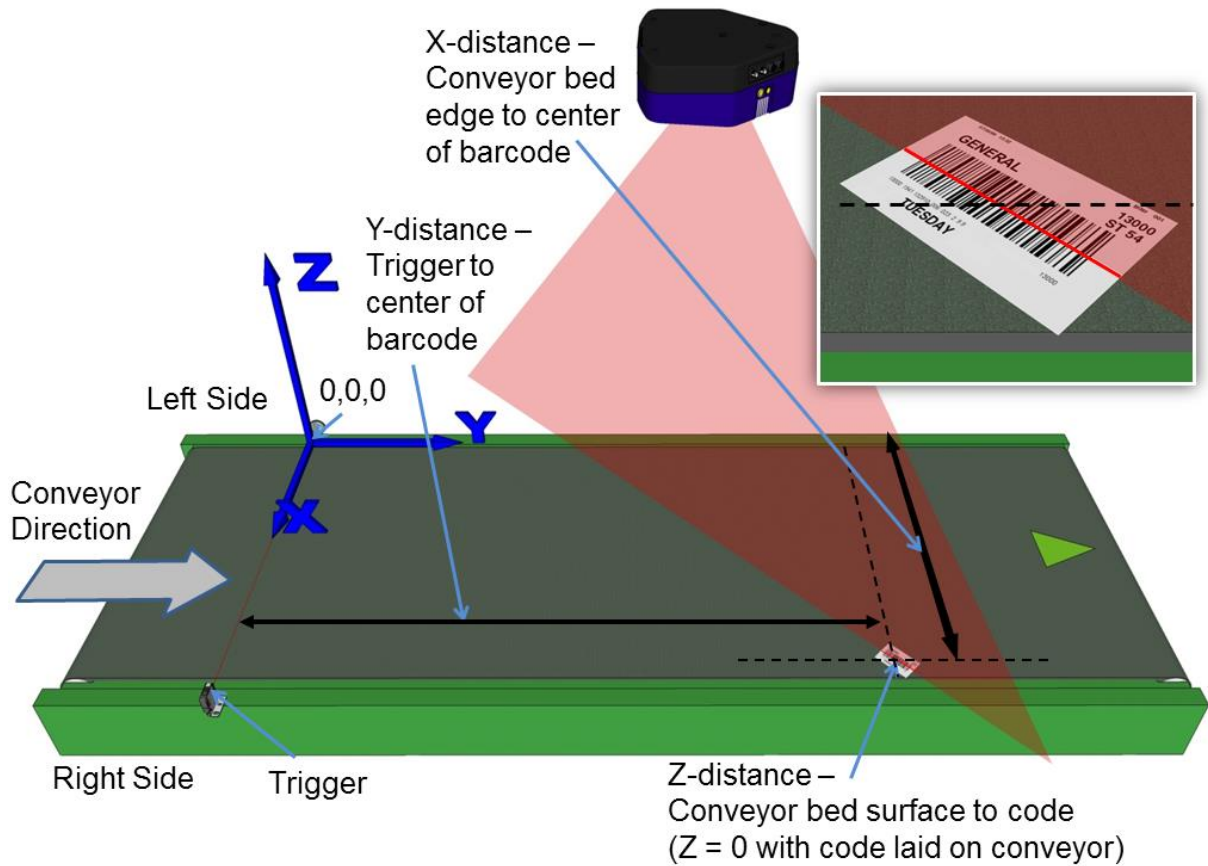

Figure 61: Top-read leg 2- 3rd barcode placement

31. Measure the distance for **X** from the left edge of the conveyor bed to the center of the barcode, and enter that distance in the first box under **X-Coord (mm)**.

Your measurements will likely differ from those shown below.

| X-Coord (mm) | Y-Coord (mm) | Z-Coord (mm) |
|--------------|--------------|--------------|
| 705 | 623 | 910 |
| 158 | 202 | 0 |
| 1030 | | |

32. Measure the distance for **Y** from the trigger (PS line) to the barcode scanner's laser line on the barcode, and enter that distance in the first box under **Y-Coord (mm)**.

Your measurements will likely differ from those shown below.

| X-Coord (mm) | Y-Coord (mm) | Z-Coord (mm) |
|--------------|--------------|--------------|
| 705 | 623 | 910 |
| 158 | 202 | 0 |
| 1030 | 1134 | |

33. Measure the distance for **Z** from the conveyor bed to the barcode, and enter that distance in the first box under **Z-Coord (mm)**. Since the barcode is directly on the conveyor bed, the value should be "0."

Your measurements will likely differ from those shown below.

| X-Coord (mm) | Y-Coord (mm) | Z-Coord (mm) |
|--------------|--------------|--------------|
| 705 | 623 | 910 |
| 158 | 202 | 0 |
| 1030 | 1134 | 0 |

34. Click **Calibrate 3**. PackTrack data is displayed for the second code.

```
Code 3 - X/Y/Z:      1030.000000 / 1134.000000 / 0.000000
(Leg 2)  Dist/Angle: 1944.937500 / 0.317304
```

Initialize Display 1 Display 2 Display 3

| X-Coord (mm) | Y-Coord (mm) | Z-Coord (mm) |
|--------------|--------------|--------------|
| 705 | 623 | 910 |
| 158 | 202 | 0 |
| 1030 | 1134 | 0 |

Calibrate 1
Calibrate 2
Calibrate 3

Compute Result

Update

35. Click **Compute Results**. The results are displayed at the top of the **PackTrack Calibration** window.

0 - Top-X Leg2

```
Result:  0.704872  -0.056868  707.343628
         0.746137   0.108514  480.701294
         0.040237  -0.941464  1715.262817
```

Initialize Display 1 Display 2 Display 3

| X-Coord (mm) | Y-Coord (mm) | Z-Coord (mm) |
|--------------|--------------|--------------|
| 705 | 623 | 910 |
| 158 | 202 | 0 |
| 1030 | 1134 | 0 |

Calibrate 1
Calibrate 2
Calibrate 3

Compute Result

Update

36. Click **Update**. "Update Successful" should be displayed in the **PackTrack Calibration** window.

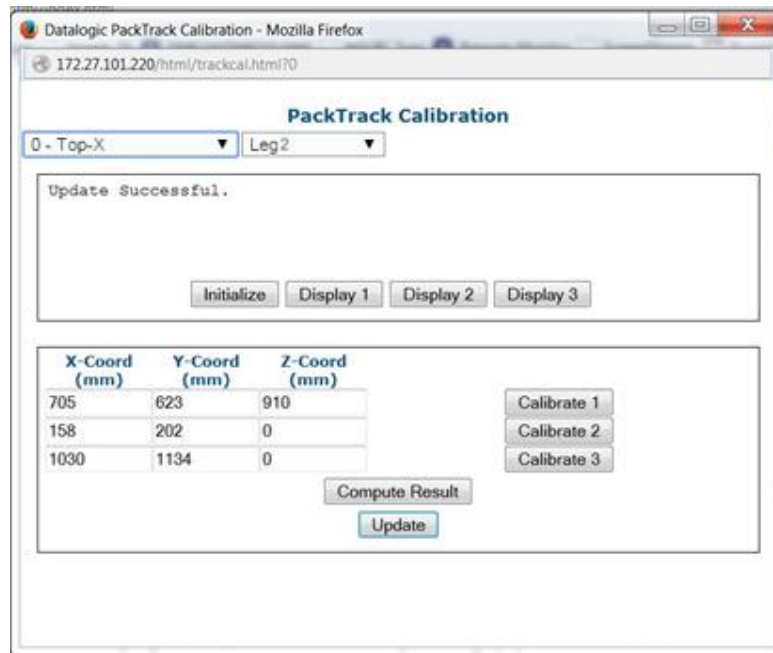

37. Close the **PackTrack Calibration Wizard** window. **PackTrack Calibration Coefficients** have been populated on the Scanner Mounting widow.

| PackTrack Calibration Coefficients | |
|------------------------------------|-------------|
| Y Adjustment | 0 mm |
| Calibration Item 1 | 0.748256 |
| Calibration Item 2 | 0.074221 |
| Calibration Item 3 | 541.760010 |
| Calibration Item 4 | -0.696657 |
| Calibration Item 5 | 0.090266 |
| Calibration Item 6 | 474.549408 |
| Calibration Item 7 | -0.025756 |
| Calibration Item 8 | -0.929790 |
| Calibration Item 9 | 1714.043823 |

38. When you have finished making changes, click **Update All** to save all pending changes, click **Reset All** to revert to all previously saved values, and click **Reset Page** to revert to previous saved values on the current page.
39. See **Verifying PackTrack Calibration** (section 5.7.4).

5.7.3 Side-Mounted Barcode Scanner Calibration Using PackTrack



NOTE: It is not possible to illustrate every possible installation angle and scanner mounting position in this manual. Use the following steps as a general guide to calibrating each system scanner using barcodes in three positions. You will need to make adjustments to the label/box position based on your situation. It is, however, important to note the fixed XYZ coordinates of the conveyor.

With the belt stopped, measure and enter the barcode XYZ coordinate data for each scanner as follows:

1. Make sure that the intended scanner (in a multi-head system) and **Leg1** have been selected from the drop-down lists at the top of the wizard window.

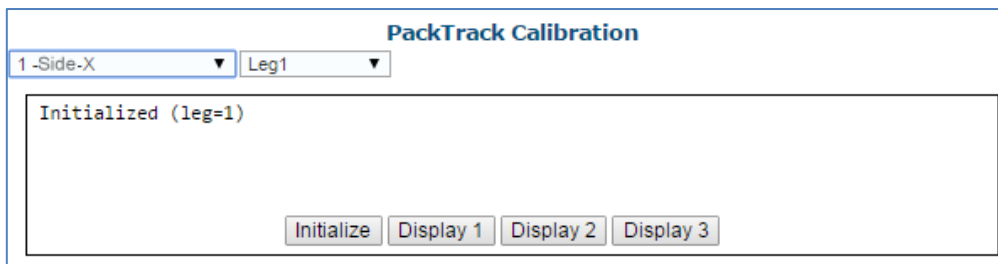

2. Start by placing a system barcode at a 45-degree angle centered on the edge of a box as shown below. Set the box, with the barcode in the scan line, close to the left edge of the conveyor bed. The label should be placed close to the conveyor bed.

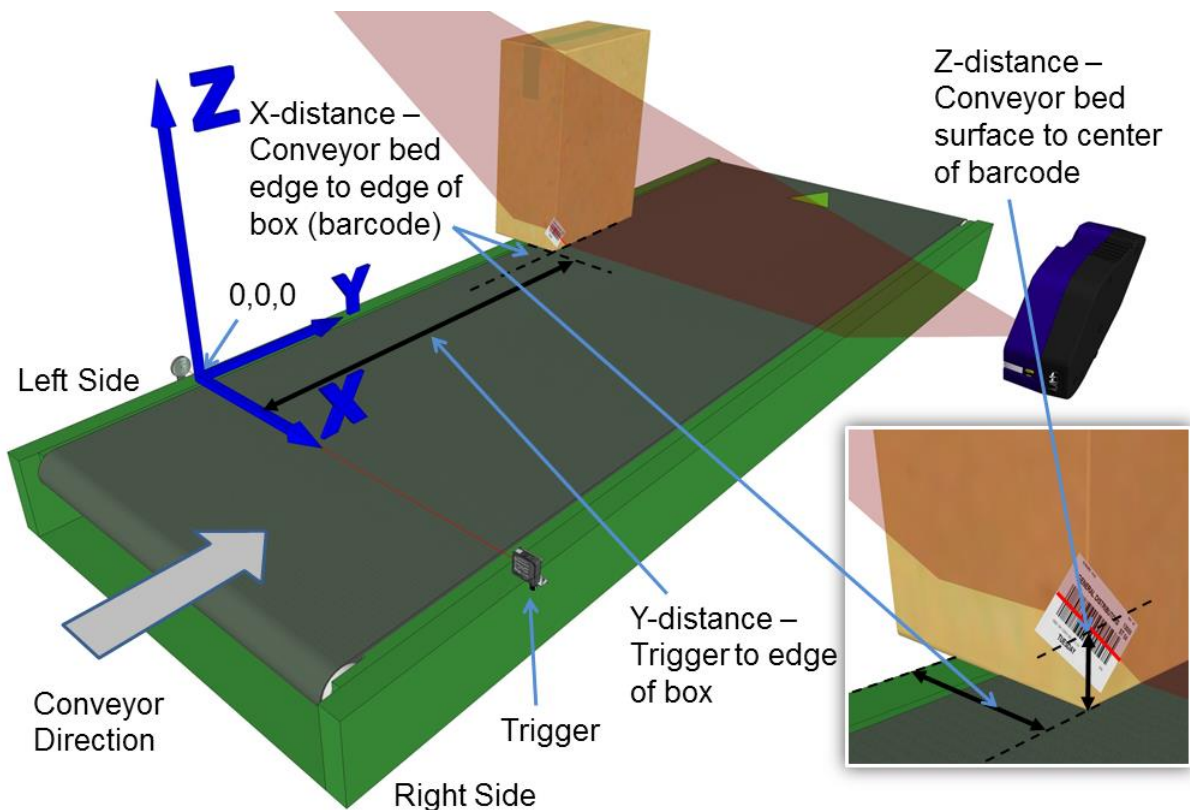

Figure 62: Side-read 1st barcode placement

3. Measure the distance for **X** from the edge of the conveyor bed to the barcode (right edge of box), and enter that distance in the first box under **X-Coord (mm)** in the **PackTrack Calibration Wizard**.

Your measurements will likely differ from those shown below.

| X-Coord (mm) | Y-Coord (mm) | Z-Coord (mm) |
|--------------|--------------|--------------|
| 153 | | |
| | | |
| | | |

4. Measure the distance for **Y** from the trigger (PS line) to the center of the barcode (edge of the box), and enter that distance in the first box under **Y-Coord (mm)**.



NOTE: To make it easier to measure the Y-Coordinate, place a box along the photoelectric sensor laser line (Trigger). Then the end of the tape measure or ruler can be placed against the edge of the box. See *below*.

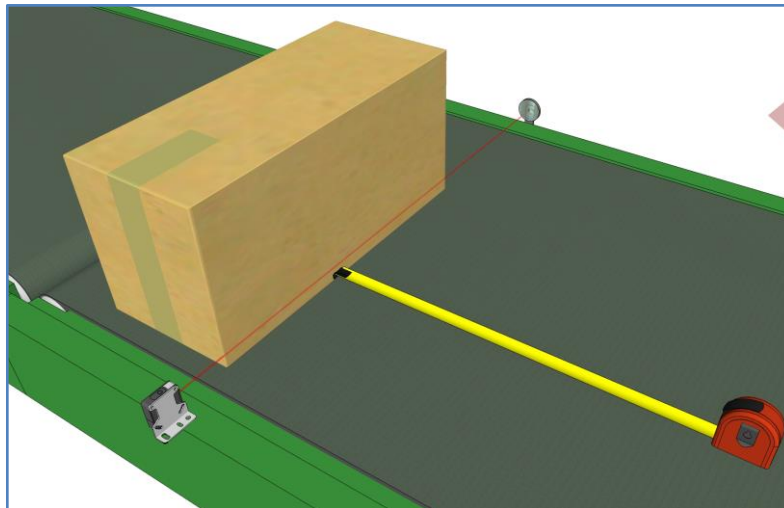

Figure 63: Measuring from trigger

Your measurements will likely differ from those shown below.

| X-Coord (mm) | Y-Coord (mm) | Z-Coord (mm) |
|--------------|--------------|--------------|
| 153 | 864 | |
| | | |
| | | |

5. Measure the distance for **Z** from the conveyor bed to the center of the barcode, and enter that distance in the first box under **Z-Coord (mm)**.

Your measurements will likely differ from those shown below.

| X-Coord (mm) | Y-Coord (mm) | Z-Coord (mm) |
|--------------|--------------|--------------|
| 153 | 864 | 65 |
| | | |
| | | |

6. Click **Calibrate 1**. PackTrack data is displayed for the first code.

Code 1 - X/Y/Z: 153.000000 / 864.000000 / 65.000000
 (Leg 1) Dist/Angle: 1406.775000 / 0.204170

| X-Coord (mm) | Y-Coord (mm) | Z-Coord (mm) |
|--------------|--------------|--------------|
| 153 | 864 | 65 |
| | | |
| | | |

7. Next, place a barcode overhanging the top corner of the tallest box specified for your scanning system as shown in the illustration below. Place the box close to the left edge of the conveyor bed, aligning the top corner with the laser line as shown.

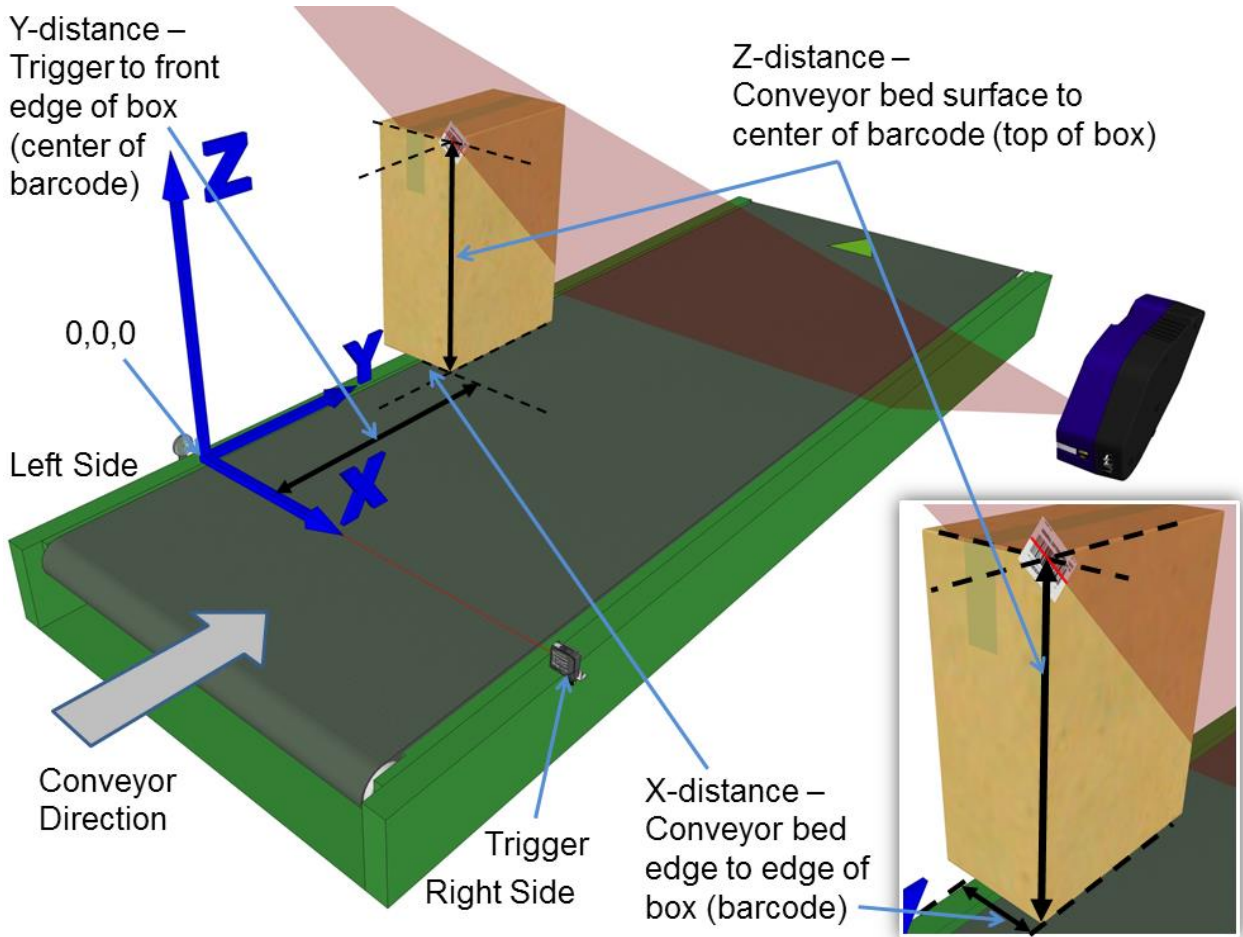

Figure 64: Side-read 2nd barcode placement

8. Measure the distance for **X** from the left edge of the conveyor bed to the center of the barcode (right edge of box), and enter that distance in the first box under **X-Coord (mm)**.

Your measurements will likely differ from those shown below.

| X-Coord (mm) | Y-Coord (mm) | Z-Coord (mm) |
|--------------|--------------|--------------|
| 153 | 864 | 65 |
| 153 | | |
| | | |

9. Measure the distance for **Y** from the trigger (PS line) to the center of the barcode (leading edge of the box), and enter that distance in the first box under **Y-Coord (mm)**.

Your measurements will likely differ from those shown below.

| X-Coord (mm) | Y-Coord (mm) | Z-Coord (mm) |
|--------------|--------------|--------------|
| 153 | 864 | 65 |
| 153 | 1540 | |
| | | |

10. Measure the distance for **Z** from the conveyor bed to the center of the barcode (top of box), and enter that distance in the first box under **Z-Coord (mm)**.

Your measurements will likely differ from those shown below.

| X-Coord (mm) | Y-Coord (mm) | Z-Coord (mm) |
|--------------|--------------|--------------|
| 153 | 864 | 65 |
| 153 | 1540 | 760 |
| | | |

11. Click **Calibrate 2**. PackTrack data is displayed for the second code.

```
Code 2 - X/Y/Z:      153.000000 / 1540.000000 / 760.000000
(Leg 1)  Dist/Angle: 1595.687500 / -0.416537
```

| X-Coord (mm) | Y-Coord (mm) | Z-Coord (mm) |
|--------------|--------------|--------------|
| 153 | 864 | 65 |
| 153 | 1540 | 760 |
| | | |

12. Place a system barcode on the right edge of a box, about halfway up the scanner field of view as shown in the illustration below.

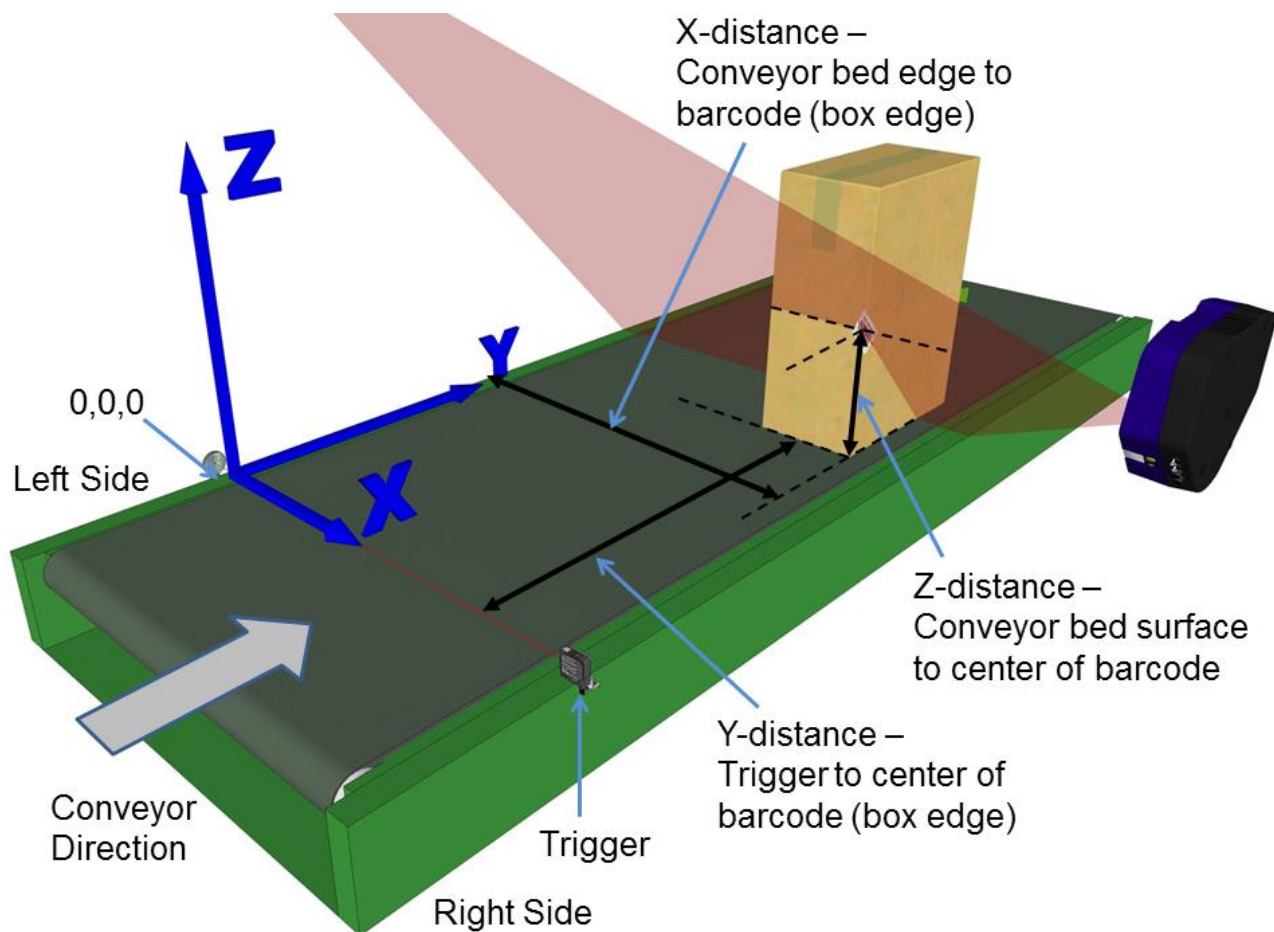

Figure 65: Side-read 3rd barcode placement

13. Measure the distance for **X** from the left edge of the conveyor bed to the barcode (right edge of box), and enter that distance in the first box under **X-Coord (mm)**.

Your measurements will likely differ from those shown below.

| X-Coord (mm) | Y-Coord (mm) | Z-Coord (mm) |
|--------------|--------------|--------------|
| 153 | 864 | 65 |
| 153 | 1540 | 760 |
| 903 | | |

14. Measure the distance for **Y** from the trigger (PS line) to the center of the barcode (leading edge of box), and enter that distance in the first box under **Y-Coord (mm)**.

Your measurements will likely differ from those shown below.

| X-Coord (mm) | Y-Coord (mm) | Z-Coord (mm) |
|--------------|--------------|--------------|
| 153 | 864 | 65 |
| 153 | 1540 | 760 |
| 903 | 928 | |

15. Measure the distance for **Z** from the conveyor bed to the laser line intersecting the barcode (center of barcode), and enter that distance in the first box under **Z-Coord (mm)**.

Your measurements will likely differ from those shown below.

| X-Coord (mm) | Y-Coord (mm) | Z-Coord (mm) |
|--------------|--------------|--------------|
| 153 | 864 | 65 |
| 153 | 1540 | 760 |
| 903 | 928 | 303 |

16. Click **Calibrate 3**. PackTrack data is displayed for the third code.

```
Code 3 - X/Y/Z:      903.000000 / 928.000000 / 303.000000
(Leg 1)  Dist/Angle: 646.362500 / 0.093144
```

| X-Coord (mm) | Y-Coord (mm) | Z-Coord (mm) |
|--------------|--------------|--------------|
| 153 | 864 | 65 |
| 153 | 1540 | 760 |
| 903 | 928 | 303 |

17. Click **Compute Results**. The results are displayed at the top of the **PackTrack Calibration** window.

```
Result:  -0.087326  -0.995023  1548.607300
          -0.714644   0.131983  886.024170
          -0.754781  -0.092767  408.076813
```

| X-Coord (mm) | Y-Coord (mm) | Z-Coord (mm) |
|--------------|--------------|--------------|
| 153 | 864 | 65 |
| 153 | 1540 | 760 |
| 903 | 928 | 303 |

18. Click **Update**. "Update Successful" should be displayed in the **PackTrack Calibration** window.

19. Select **Leg2** from the drop-down list at the top of the wizard window.

20. Reposition the system barcode, rotating it on the box, so it matches the angle of the Leg 2 laser line. Set the box, with the barcode in the scan line, close to the left edge of the conveyor bed. The label should be placed close to the conveyor bed.

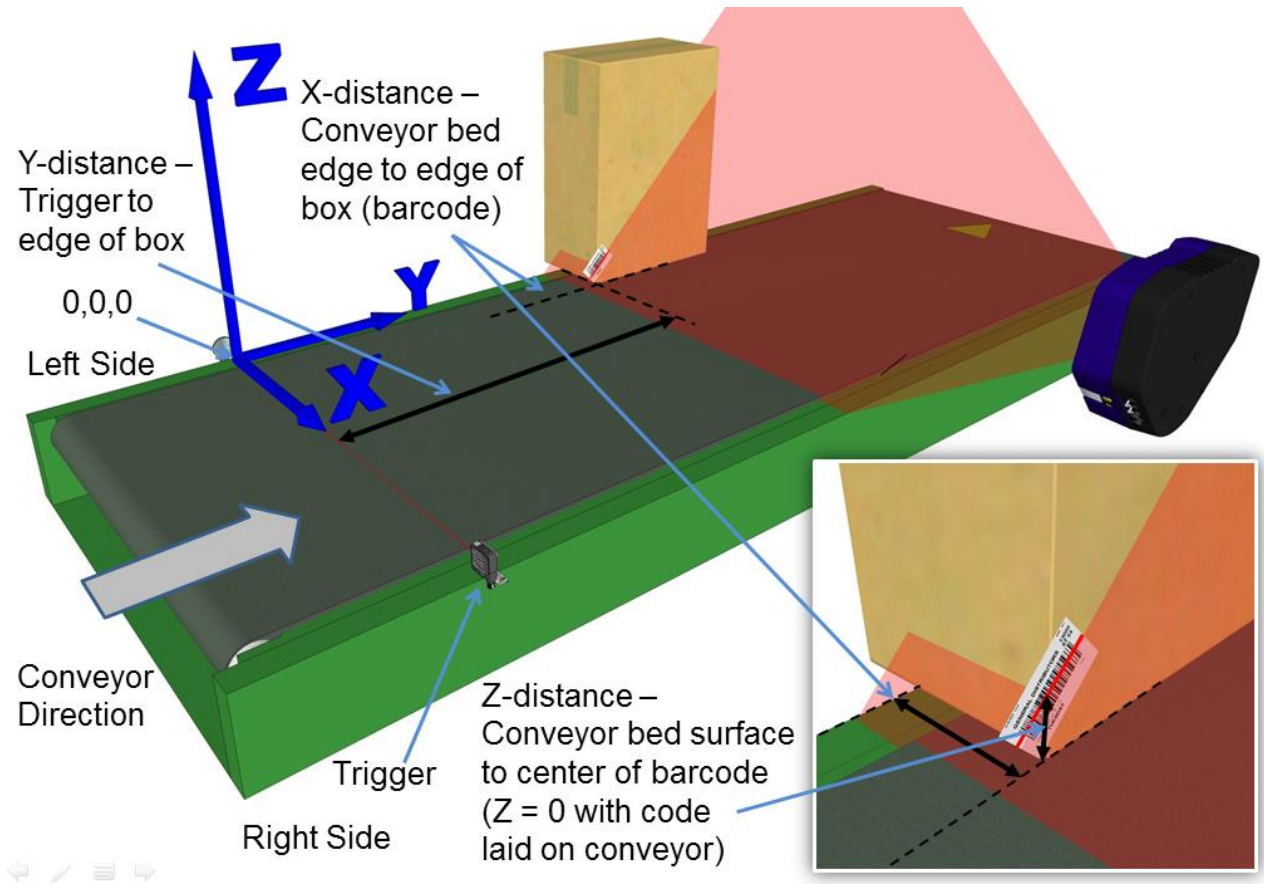

Figure 66: Side-read 1st barcode placement

21. Measure the distance for **X** from the left edge of the conveyor bed to the barcode (right edge of box), and enter that distance in the first box under **X-Coord (mm)** in the **PackTrack Calibration Wizard**.

Your measurements will likely differ from those shown below.

| X-Coord (mm) | Y-Coord (mm) | Z-Coord (mm) |
|--------------|--------------|--------------|
| 153 | | |
| | | |
| | | |

22. Measure the distance for **Y** from the trigger (PS line) to the leading edge of the box, and enter that distance in the first box under **Y-Coord (mm)**.

Your measurements will likely differ from those shown below.

| X-Coord (mm) | Y-Coord (mm) | Z-Coord (mm) |
|--------------|--------------|--------------|
| 153 | 1370 | |
| | | |
| | | |

23. Measure the distance for **Z** from the conveyor bed to the center of the barcode, and enter that distance in the first box under **Z-Coord (mm)**.

Your measurements will likely differ from those shown below.

| X-Coord (mm) | Y-Coord (mm) | Z-Coord (mm) |
|--------------|--------------|--------------|
| 153 | 1370 | 60 |
| | | |
| | | |

24. Click **Calibrate 1**. PackTrack data is displayed for the first code.

```
Code 1 - X/Y/Z:      153.000000 / 1370.000000 / 60.000000
(Leg 2)  Dist/Angle: 1468.687500 / 0.230248
```

| X-Coord (mm) | Y-Coord (mm) | Z-Coord (mm) |
|--------------|--------------|--------------|
| 153 | 1370 | 60 |
| | | |
| | | |

25. Next, place a system barcode overhanging the top corner of the tallest box specified for your scanning system as shown in the illustration below. Place the box close to the left edge of the conveyor bed, aligning the top corner with the laser line as shown.

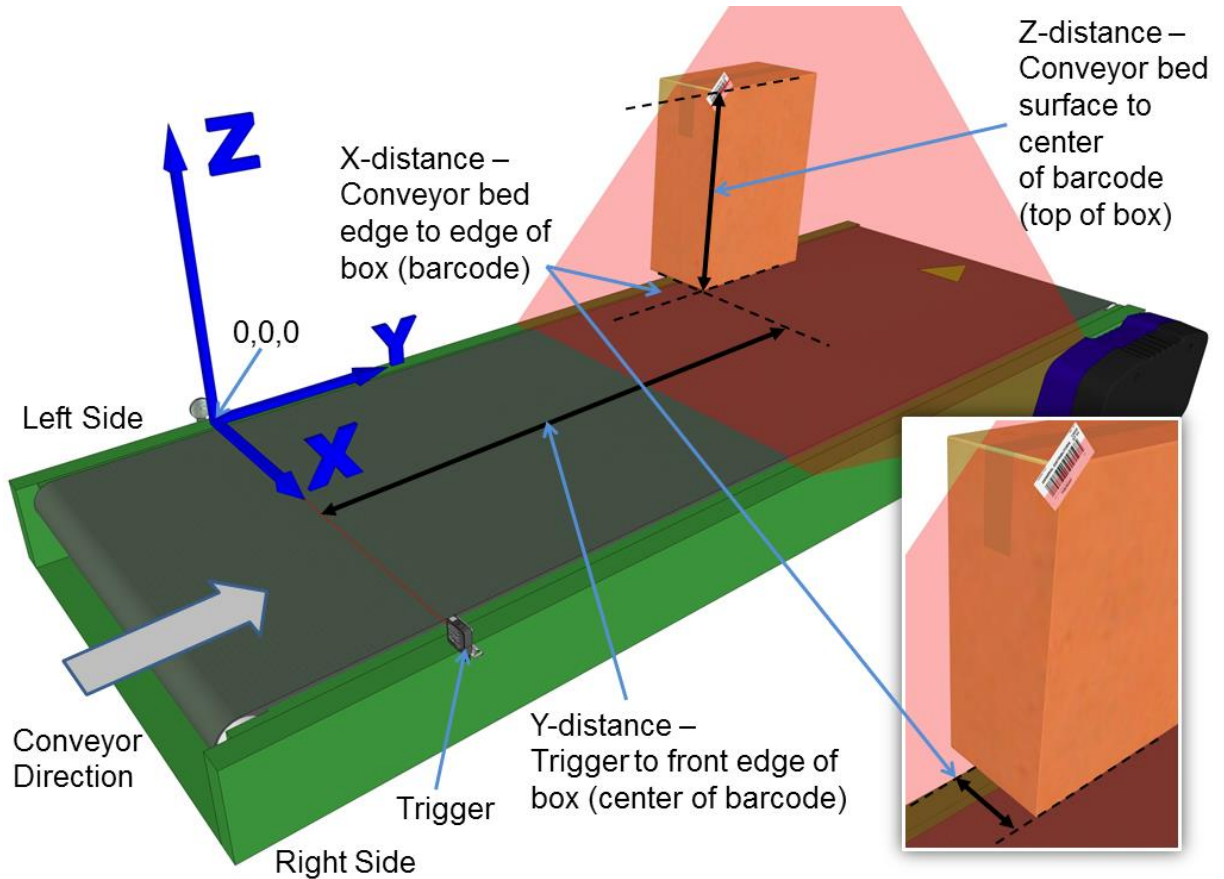

Figure 67: Side-read 2nd barcode placement

26. Measure the distance for **X** from the left edge of the conveyor bed to the center of the barcode (right edge of box), and enter that distance in the first box under **X-Coord (mm)**.

Your measurements will likely differ from those shown below.

| X-Coord (mm) | Y-Coord (mm) | Z-Coord (mm) |
|--------------|--------------|--------------|
| 153 | 1370 | 60 |
| 153 | | |
| | | |

27. Measure the distance for **Y** from the trigger (PS line) to the leading edge of the box, and enter that distance in the first box under **Y-Coord (mm)**.

Your measurements will likely differ from those shown below.

| X-Coord (mm) | Y-Coord (mm) | Z-Coord (mm) |
|--------------|--------------|--------------|
| 153 | 1370 | 60 |
| 153 | 642 | |
| | | |

28. Measure the distance for **Z** from the conveyor bed to the center of the barcode (top of box), and enter that distance in the first box under **Z-Coord (mm)**.

Your measurements will likely differ from those shown below.

| X-Coord (mm) | Y-Coord (mm) | Z-Coord (mm) |
|--------------|--------------|--------------|
| 153 | 1370 | 60 |
| 153 | 642 | 760 |
| | | |

29. Click **Calibrate 2**. PackTrack data is displayed for the second code.

```
Code 2 - X/Y/Z:      153.000000 / 642.000000 / 760.000000
(Leg 2)  Dist/Angle: 1489.325000 / -0.424111
```

Initialize Display 1 Display 2 Display 3

| X-Coord (mm) | Y-Coord (mm) | Z-Coord (mm) |
|--------------|--------------|--------------|
| 153 | 1370 | 60 |
| 153 | 642 | 760 |
| | | |

Calibrate 1
Calibrate 2
Calibrate 3

Compute Result
Update

30. Finally, place a system barcode on the leading right edge of a small box close to the conveyor bed, as shown in the illustration below.

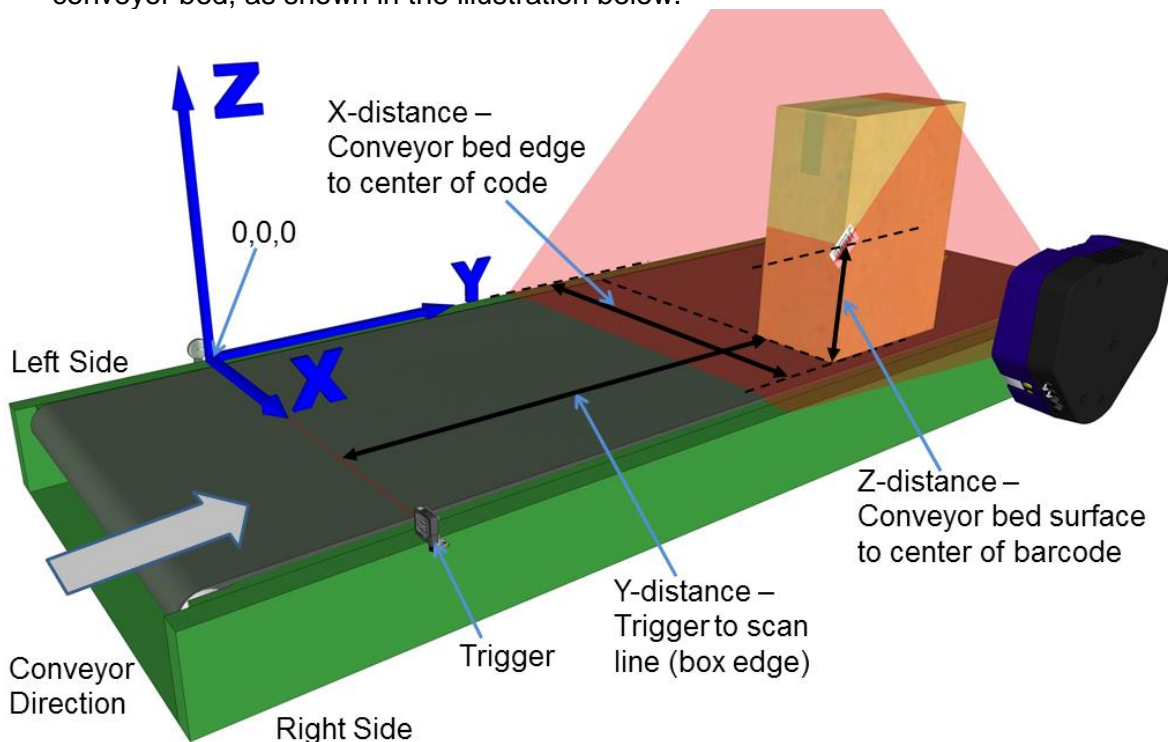

Figure 68: Side-read 3rd barcode placement

31. Measure the distance for **X** from the left edge of the conveyor bed to the center of the barcode (right edge of box), and enter that distance in the first box under **X-Coord (mm)**.

Your measurements will likely differ from those shown below.

| X-Coord (mm) | Y-Coord (mm) | Z-Coord (mm) |
|--------------|--------------|--------------|
| 153 | 1370 | 60 |
| 153 | 642 | 760 |
| 903 | | |

32. Measure the distance for **Y** from the trigger (PS line) to the barcode scanner's laser line on the barcode (leading edge of box), and enter that distance in the first box under **Y-Coord (mm)**.

Your measurements will likely differ from those shown below.

| X-Coord (mm) | Y-Coord (mm) | Z-Coord (mm) |
|--------------|--------------|--------------|
| 153 | 1370 | 60 |
| 153 | 642 | 760 |
| 903 | 947 | |

33. Measure the distance for **Z** from the conveyor bed to the center of the barcode, and enter that distance in the first box under **Z-Coord (mm)**.

Your measurements will likely differ from those shown below.

| X-Coord (mm) | Y-Coord (mm) | Z-Coord (mm) |
|--------------|--------------|--------------|
| 153 | 1370 | 60 |
| 153 | 642 | 760 |
| 903 | 947 | 304 |

34. Click **Calibrate 3**. PackTrack data is displayed for the third code.

```
Code 3 - X/Y/Z:      903.000000 / 947.000000 / 304.000000
(Leg 2)  Dist/Angle: 628.900000 / -0.060546
```

| X-Coord (mm) | Y-Coord (mm) | Z-Coord (mm) |
|--------------|--------------|--------------|
| 153 | 1370 | 60 |
| 153 | 642 | 760 |
| 903 | 947 | 304 |

35. Click **Compute Results**. The results are displayed at the top of the **PackTrack Calibration** window.

1 -Side-X Leg2

Result: 0.074189 -0.969470 1514.405518
 0.754395 0.176309 865.030212
 -0.741477 0.040822 250.157791

Initialize Display 1 Display 2 Display 3

| X-Coord (mm) | Y-Coord (mm) | Z-Coord (mm) |
|--------------|--------------|--------------|
| 153 | 1370 | 60 |
| 153 | 642 | 760 |
| 903 | 947 | 304 |

Calibrate 1
Calibrate 2
Calibrate 3

Compute Result
Update

36. Click **Update**. "Update Successful" should be displayed in the **PackTrack Calibration** window.
37. Close the **PackTrack Calibration Wizard** window. **PackTrack Calibration Coefficients** have been populated on the Scanner Mounting window.

PackTrack Calibration Coefficients

Y Adjustment mm

Calibration Item 1 0.074189

Calibration Item 2 -0.969470

Calibration Item 3 1514.405518

Calibration Item 4 0.754395

Calibration Item 5 0.176309

Calibration Item 6 865.030212

Calibration Item 7 -0.741477

Calibration Item 8 0.040822

Calibration Item 9 250.157791

38. When you have finished making changes, click **Update All** to save all pending changes, click **Reset All** to revert to all previously saved values, and click **Reset Page** to revert to previous saved values on the current page.
39. See **Verifying PackTrack Calibration** (*section 5.7.4*).

5.7.4 Verifying PackTrack Calibration

1. In the menu tree, navigate to **Diagnostics/Read Test**. The **Read Test** window opens.

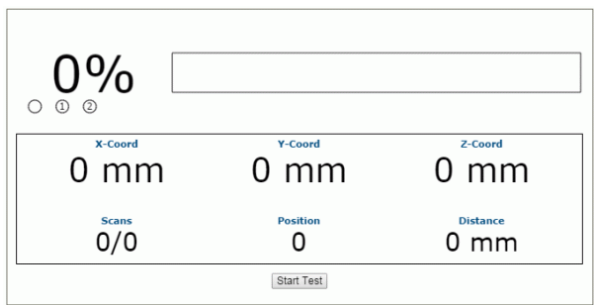

2. Place a barcode anywhere in the scanner's laser beam other than where you placed the labels for calibration.

3. Click **Start Test**. The system runs a test to identify the location of the barcode within the read area and displays the results in the Read Test window.

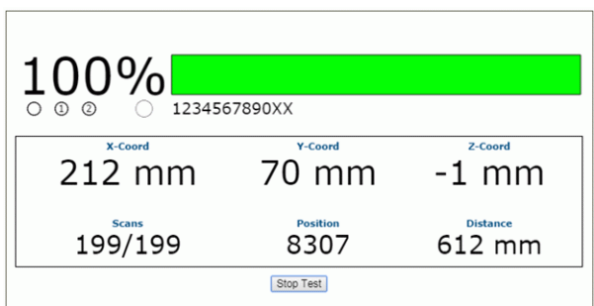

4. Physically measure the X (from left edge), Y (From PS), and Z (code height) coordinates of your test barcode, and compare your measured results to the Read Test results. Your measured results and those displayed should be close (within a few millimeters) but do not need to be exact.

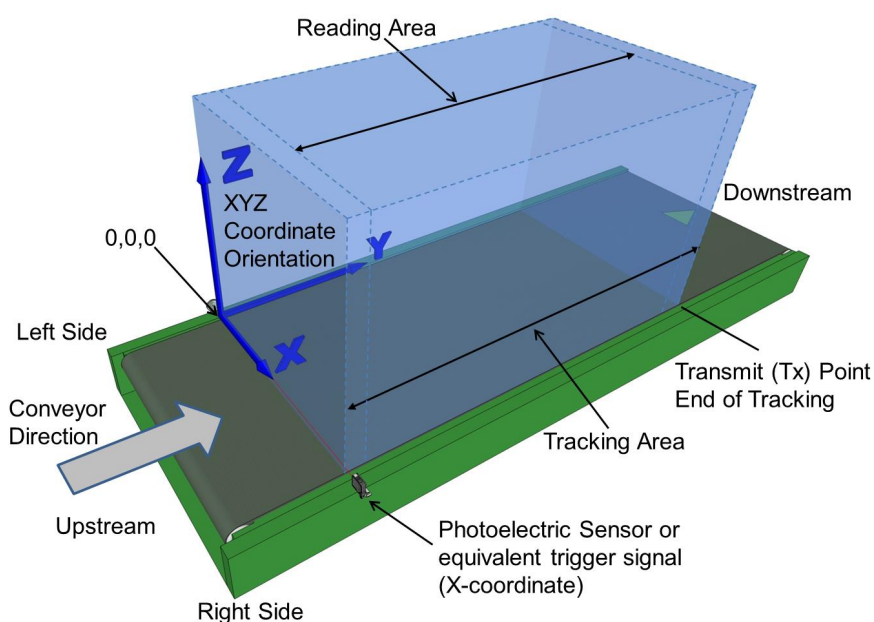

Figure 69: Tracking Area

5. Next, in the menu tree, navigate to **Diagnostics/Monitor**.
6. Turn on conveyor and run a box with a readable barcode past the barcode scanner.
7. Check the **Monitor** to make sure the barcode on the box is being read. If you see a no read (the barcode doesn't read on the box), double check your physical measurements you entered in the **PackTrack Calibration Wizard**, and enter them again.

| Status | | Barcode Information | |
|--|-----------------------------------|---|-------------------------------|
| <input type="checkbox"/> Phase/Trigger | <input type="checkbox"/> Output 1 | Code Distance | 1158 mm |
| <input type="checkbox"/> Good/No Read | <input type="checkbox"/> Output 2 | Scan Position: | 8220 |
| <input type="checkbox"/> Multiple | | | <input type="checkbox"/> Near |
| <input type="checkbox"/> Partial | | | <input type="checkbox"/> Far |
| Belt Speed: 0.716 m/s | | | |
| Messages | | Read Rate | |
| Tx:149780 DS8110-DX8210 - Dev:0 | | Package Count | |
| Tx:149780 Code128-54321 - Dev:0 | | 149782 | |
| Tx:149780 1234567891231 - Dev:0 | | Good Read (%) | |
| Tx:149780 <PARTIAL> - Encoder Start/End:99751148/99751591 | | 0.00% | |
| Placed Label (149785): 3219876543215 - Dev:0 Laser:2 - Adj Enc:99754843 | | Multiple (%) | |
| Placed Label (149786): 101674471304 - Dev:0 Laser:2 - Adj Enc:99755347 | | 0.00% | |
| Tx:149781 689888883292 - Dev:0 | | Partial (%) | |
| Tx:149781 3219876543215 - Dev:0 | | 100% | |
| Tx:149781 <PARTIAL> - Encoder Start/End:99751807/99752273 | | No Read (%) | |
| Placed Label (149786): 123456789128 - Dev:0 Laser:2 - Adj Enc:99755440 | | 0.00% | |
| <input type="button" value="Reset"/> | | | |
| Message Monitor | | | |
| <ESC>[<SB1><VT><NUL><NUL><NUL><SOH>R | | | |
| <STX>/C128-689888883292/?????????/CR><LF> | | | |
| <STX>/C128-101674471304/?????????/CR><LF> | | | |
| <STX>/C128-Code128-09876/?????????/CR><LF> | | | |
| <STX>/#####C128-Code128-54321/CR><LF> | | | |
| <STX>/C128-689888883292/?????????/CR><LF> | | | |
| <input type="radio"/> None <input type="radio"/> Main <input checked="" type="radio"/> Aux <input type="radio"/> Socket 1 <input type="radio"/> Socket 2 <input type="radio"/> Socket 3 <input type="radio"/> Socket 4 <input type="radio"/> Socket 5 <input type="radio"/> Socket 6 | | | |
| <input type="button" value="Connect"/> | | <input type="button" value="Disconnect"/> | |

5.8 REPLACING AN INSTALLED DX8210

If for any reason, a scanner fails, it can be replaced quickly with a spare unit with parameters recovered from flash memory or a saved parameter file.



NOTE: This procedure assumes that system parameters have been properly saved as described in sections 4.8.1, 5.2 and 5.3.



NOTE: If you are not sure the replacement scanner has been defaulted to factory settings, it is a good idea to default the unit before installing it in a system. To do this:

1. Attach a power cable to the replacement scanner and apply power.
2. Simultaneously, press and hold down the yellow X-Press and Restore buttons on the unit until the LEDs flash three times.
3. Release the buttons. The unit is now reset to the factory default.

5.8.1 Replacing a Standalone Scanner Using Restore

A standalone scanner (a single scanner not connected to an array/tunnel) can be replaced using the Restore button located near the LEDs on the side of the housing.



Figure 70: Restore Button

To replace the scanner using Restore:

1. Remove power from the existing scanner and remove the power and I/O cables.
2. Label the cables attached to ETH1 and/or ETH2 so you can easily identify where they were connected, then remove the cables.
3. Detach the existing scanner from its mounting bracket, leaving the bracket attached to the mounting structure.
4. Attach the replacement scanner to the mounting bracket.
5. Reattach the power, I/O, ETH1 and/or ETH2 cables.
6. Apply power to the system.
7. Once the scanner has booted up and the **READY** LED lights solid green, press and hold the **RESTORE** button until all of the LEDs turn on, indicating that the parameters are being restored from the CBX510's BM100 backup module.

- Release the **RESTORE** button. The green **READY** LED should come back on.

5.8.2 Replacing a Slave Scanner in an Array/Tunnel Automatically

e-Genius provides an option for automatically replacing a slave scanner in a tunnel when the system is configured. To enable this option in **e-Genius**, select **Modify Setting/System Info** from the **e-Genius** menu tree. The System Info window opens.

| Model | Dev | MAC Addr | Software Version | Description | ID |
|-------|-----|--------------|----------------------|-----------------|----|
| | 0 | 000E13040103 | ARM_release_v0_9_0_0 | Top-X | ID |
| | 1 | 0007BE00F238 | ARM_release_v0_9_0_0 | Left-Front-Line | ID |

Select the **Enable Automatic Slave Replacement** check box, click **Update**, and save the system parameters as described in sections 4.8.1, 5.2 and 5.3.

If the **Enable Automatic Slave Replacement** check box has been selected and saved in the system parameters, use the following procedure to replace a slave scanner:

- Remove power from the array.
- Remove the power and I/O cables from the scanner being replaced.
- Label the cables attached to ETH1 and/or ETH2 so you can easily identify where they were connected, then remove the cables.
- Detach the existing scanner from its mounting bracket, leaving the bracket attached to the mounting structure.
- Attach the replacement scanner to the mounting bracket.
- Reattach the power, I/O, ETH1 and/or ETH2 cables.
- Apply power to the array. The system will automatically find and download system parameters to the replacement scanner.

5.8.3 Replacing a Slave Scanner in an Array/Tunnel Using Restore

If the **Enable Automatic Slave Replacement** check box has NOT been selected and saved in the system parameters, use the following procedure to replace a slave scanner:

1. Remove power from the array.
2. Remove the power and I/O cables from the scanner being replaced.
3. Label the cables attached to ETH1 and/or ETH2 so you can easily identify where they were connected, then remove the cables.
4. Detach the existing scanner from its mounting bracket, leaving the bracket attached to the mounting structure.
5. Attach the replacement scanner to the mounting bracket.
6. Reattach the power, I/O, ETH1 and/or ETH2 cables.
7. Apply power to the array.
8. Once the scanner has booted up and the **READY** LED lights solid green, press and hold the **RESTORE** button until all of the LEDs turn on, indicating that the parameters are being restored from the CBX510's BM100 backup module or SC5000 flash memory.
9. Release the **RESTORE** button.

5.8.4 Replacing a Master Scanner in an Array/Tunnel Using Restore

1. Remove power from the array.
2. Remove the power and I/O cables from the Master scanner being replaced.
3. Label the cables attached to ETH1 and/or ETH2 so you can easily identify where they were connected, then remove the cables.
4. Detach the existing scanner from its mounting bracket, leaving the bracket attached to the mounting structure.
5. Attach the replacement master scanner to the mounting bracket.
6. Reattach the power, I/O, ETH1 and/or ETH2 cables.
7. Apply power to the array.
8. Once the scanner has booted up and the **READY** LED lights solid green, press and hold the **RESTORE** button until all of the LEDs turn on, indicating that the parameters are being restored from the CBX510's BM100 backup module or SC5000 flash memory.
9. Release the **RESTORE** button.

5.8.5 Checking the Operation of the Replacement

With the scanner replaced and your PC connected to the system, navigate to **Modify Setting/System Info** from the **e-Genius** menu tree. The System Info window opens.

System Info

System Description

Role

Enable Automatic Slave Replace

Master Tools

Device Information

| | Model | Dev | MAC Addr | Software Version | Description | |
|--|-------|-----|--------------|----------------------|-------------|-----------------------------------|
| | | 0 | 0007BE0099C4 | ARM_release_v0_9_0_0 | Controller | |
| | | 1 | 0007BE00CE59 | ARM_release_v0_9_0_0 | Scanner3 | <input type="button" value="ID"/> |
| | | 2 | 0007BE00DACD | ARM_release_v0_9_0_0 | Scanner2 | <input type="button" value="ID"/> |
| | | 3 | 0007BE00EF89 | ARM_release_v0_9_0_0 | Scanner1 | <input type="button" value="ID"/> |

The **Device Information** section of the window should now list all of the scanners (and an SC5000 Controller if used), including the scanner you just replaced.

5.9 TYPICAL LAYOUTS

The following typical layouts refer to system hardware configurations, but also require the correct setup of the software configuration parameters

Other layouts require the use of a specific SC5000 Controller model.

The accessories and cables indicated in the following figures are Datalogic products. We suggest their use to guarantee the correct system functioning.

5.9.1 Large Synchronized Network Layout

When building a large local EBC (Ethernet Based Connectivity) network, an SC5000 Controller should be used together with a PWR-480B power supply unit. In this case the SC5000 unit acts as the system master and is connected to the host through one of its interfaces.

- The SC5000 can be connected to the Host in several different layouts depending on the controller model.

The SC5000 Standard models provide both Ethernet connections (direct or through a Hub/Switch) and point-to-point connections on the Main interface using either RS232 or RS422 full-duplex;

Fieldbus models, additionally provide the model specific Fieldbus: Profibus, Profinet IO, etc.

- All scanners act as slaves and are connected to the SC5000 through the EBC interface.

External devices such as a presence sensor and an encoder are all connected either to the SC5000 through its M12 circular connectors, or to the CBX510 connection box (connected to the Controller), wiring the signals through the CBX510 compression connectors.

SC5000: Basic Layout: Ethernet TCP/IP to Host

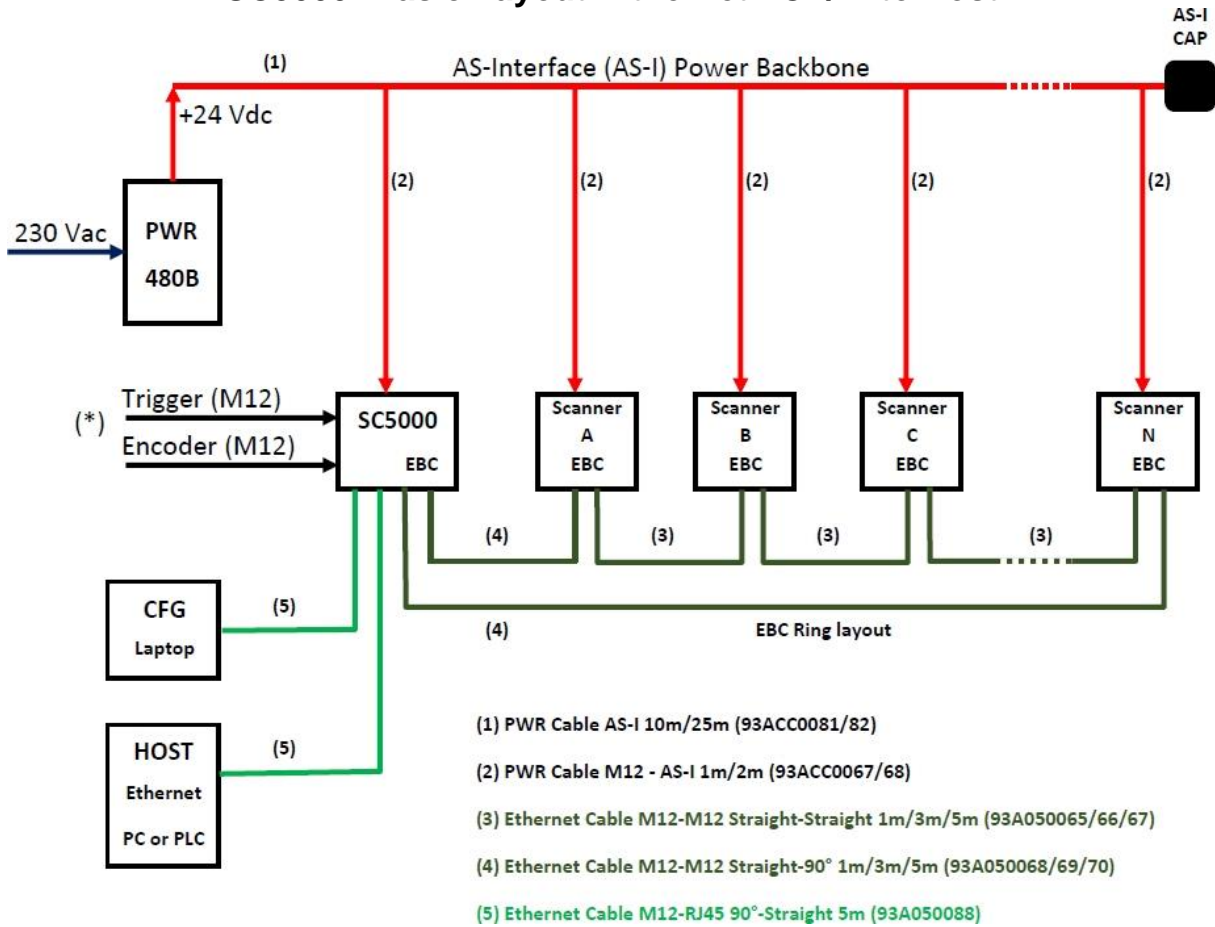

(*) If you prefer an alternative wiring connection, rather than the M12 connection type, use the CBX510 accessory, as shown below.

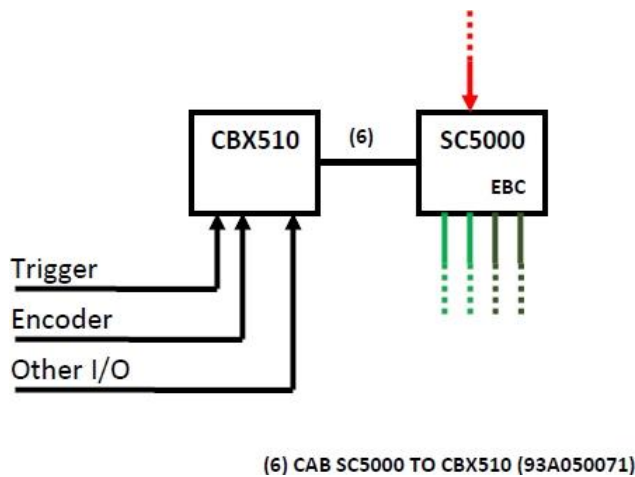

Figure 71 – Large Synchronized Network with DX8210 Scanners

SC5000: Basic Layout: COM to Host

If the Host supports a COM communication type (RS232 or RS422) rather than the Ethernet one, use the CBX510 accessory, as shown below.

The remaining part of the layout (scanners, PWR etc.) does not change.

As already mentioned, the CBX510 can also be used to wire the Trigger and Encoder signals (and other I/O) as an alternative to the M12 connection.

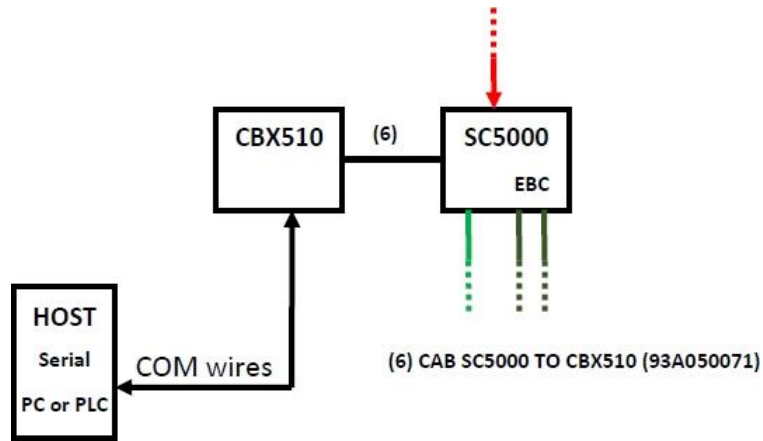

Figure 72 – Large Synchronized Network with COM to Host

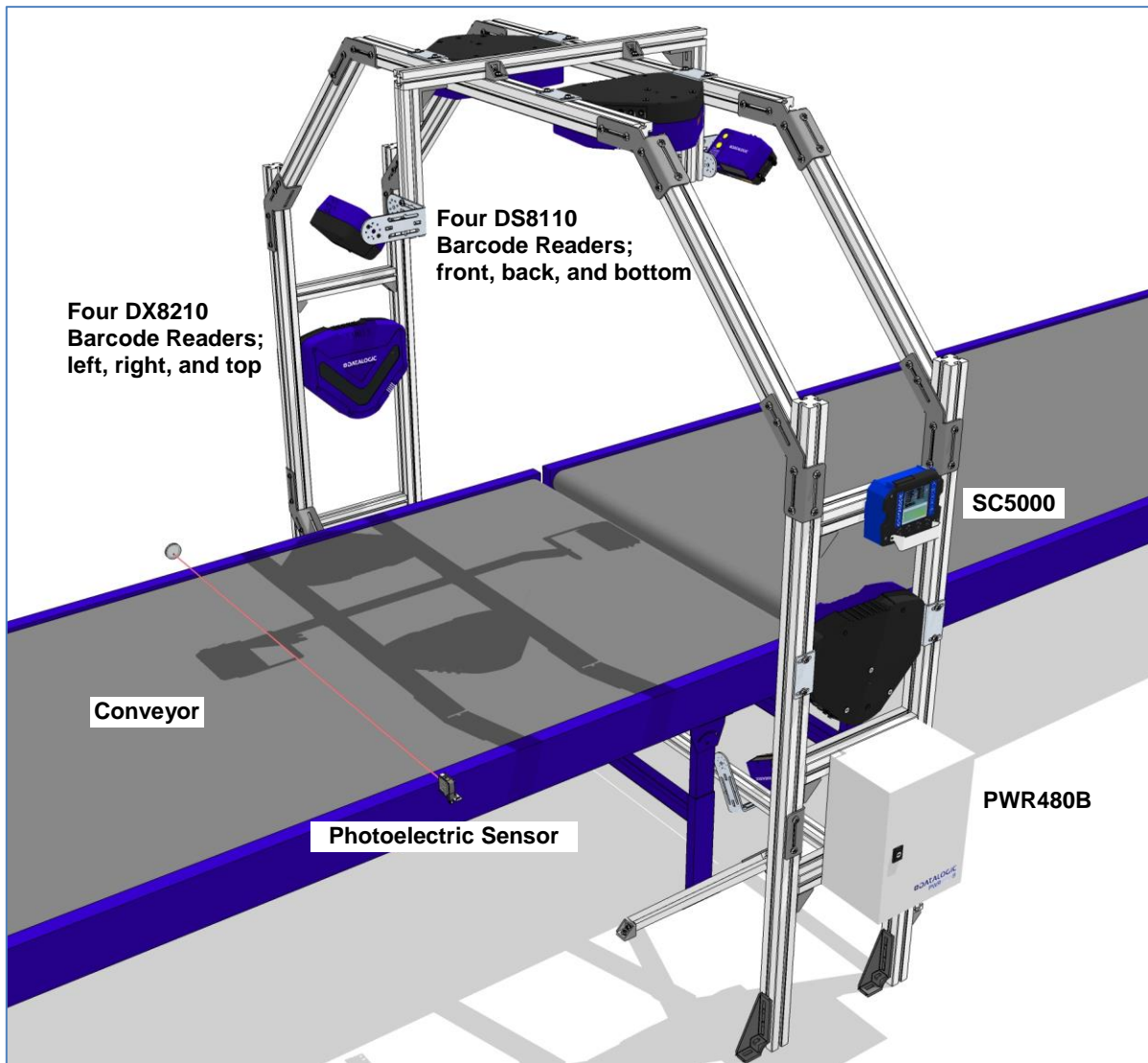

Figure 73 – Example Large Synchronized Network Reading Station

For applications having regular shaped packages, the default settings are sufficient, but for Airport applications working in PackTrack Operating Mode, irregular shaped packs can cause PS signal glitches resulting in false "packs too short" or "packs too close" errors.

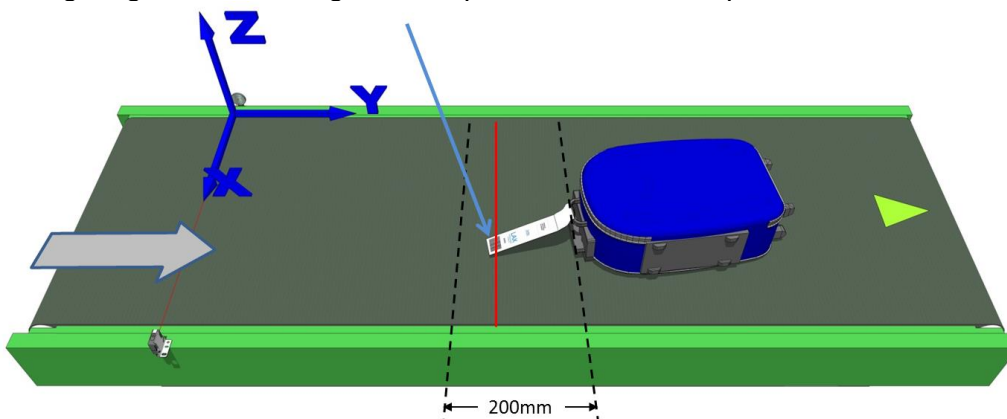

Figure 74 – Compensating for Irregular-Shaped Packages

To correct this, set the following Operating Mode parameters: Minimum Distance Between Packs = 200 mm, Minimum Pack Length = 200 mm, Window Dimension = 200 mm.

5.10 ADVANCED CODE RECONSTRUCTION (ACR™)

The traditional way of barcode reading could be called “Linear Reading”. In this case, the laser beam crosses the barcode symbol from its beginning to its end as shown in the following figure:

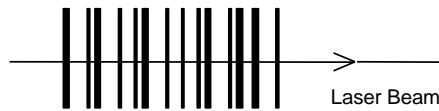

Figure 75 – Linear Reading

In Advanced Code Reconstruction mode it is no longer necessary for the laser beam to cross the label from the start to the end. With just a set of partial scans on the label (obtained using the motion of the label itself), the DX8210 is able to “reconstruct” the barcode. A typical set of partial scans is shown in the figure below:

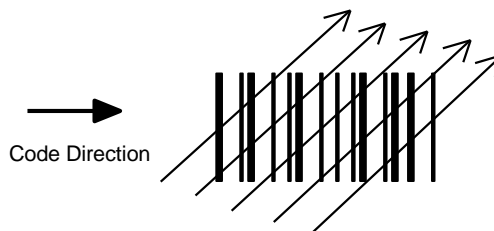

Figure 76 – Partial Scans

None of the partial scans contains the whole label. The decoder aligns each partial scan correctly and combines them in order to obtain the entire code.

The alignment is performed by calculating the time difference from one partial scan to another using a reference code element.

5.10.1 Tilt Angle for Advanced Code Reconstruction

The most important parameter in Advanced Code Reconstruction is the value of the maximum tilt angle (α maximum) under which the code reconstruction process is still possible.

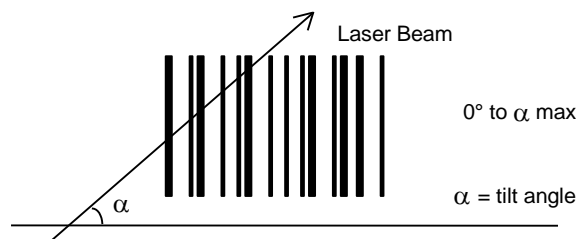

Figure 77 – Tilt Angle

The decoder will be able to read the label with a tilt angle between $+\alpha$ max and $-\alpha$ max as shown in the following figure:

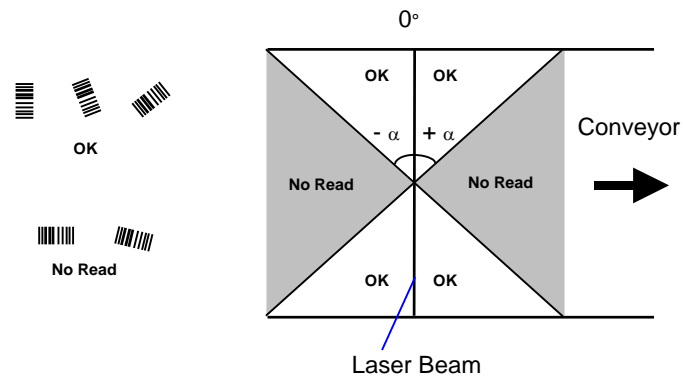

Figure 78 – Reading Zones with α Max

The formulas to calculate α maximum depend on various parameters such as: label height, number of scans per second, code motion speed, etc.

DX8210 scanners provide omnidirectional reading by dividing the scan line into two legs, which produce a cross pattern where angle α is fixed for each leg (see figure below). Since code reconstruction is used, minimum label heights at different conveyor speeds are given in the tables in *section 5.10.2*, which guarantee omnidirectional reading for your application.

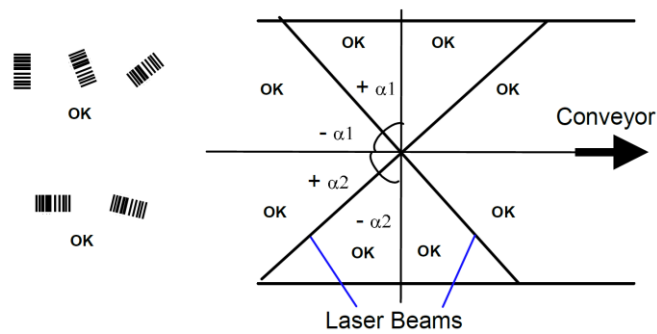

Figure 79 – X-Pattern Reading Zones with α Max

5.10.2 Minimum Code Height for Advanced Code Reconstruction

Based on the scanner read rate of 1000 scans/sec., minimum label heights at different conveyor speeds are given in the tables below.

Refer to the reading diagrams in *section 5.11* for further details on the reading features. These diagrams are taken on various resolution sample codes at a 25 °C ambient temperature depending on the conditions listed under each diagram.

- ANSI Grade B minimum
- 1000 scans/sec

The following tables describe the requirements for standard applications.

| | | Minimum Code Height for ACR Reading (mm) | | | | | |
|--|------|--|----|-----|----|-----|----|
| | | 45° | | | | | |
| Conveyor Speed (m/s) | | 0.5 | 1 | 1.5 | 2 | 2.5 | 3 |
| 2/5 Interleaved Code Resolution (mm) | 0.25 | 10 | 11 | 13 | 14 | 16 | 17 |
| | 0.30 | 12 | 13 | 14 | 16 | 17 | 19 |
| | 0.33 | 12 | 14 | 15 | 17 | 18 | 20 |
| | 0.38 | 14 | 15 | 16 | 18 | 19 | 21 |
| | 0.50 | 18 | 18 | 20 | 21 | 23 | 24 |
| | 0.72 | 24 | 25 | 26 | 27 | 28 | 30 |
| | 1.00 | 33 | 33 | 34 | 35 | 36 | 37 |

Ratio 3:1

Table 1

| | | Minimum Code Height for ACR Reading (mm) | | | | | |
|------------------------------------|------|--|----|-----|----|-----|----|
| | | 45° | | | | | |
| Conveyor Speed (m/s) | | 0.5 | 1 | 1.5 | 2 | 2.5 | 3 |
| Code 39 Code Resolution (mm) | 0.25 | 9 | 9 | 11 | 12 | 14 | 15 |
| | 0.30 | 10 | 11 | 12 | 13 | 15 | 16 |
| | 0.33 | 11 | 11 | 12 | 14 | 15 | 17 |
| | 0.38 | 12 | 13 | 13 | 15 | 16 | 18 |
| | 0.50 | 15 | 16 | 16 | 17 | 18 | 20 |
| | 0.72 | 20 | 21 | 22 | 22 | 23 | 24 |
| | 1.00 | 27 | 28 | 29 | 29 | 30 | 31 |

Ratio 3:1; Interdigit = Module Size

Table 2

| | | Minimum Code Height for ACR Reading (mm) | | | | | |
|---|------|--|----|-----|----|-----|----|
| | | 45° | | | | | |
| Conveyor Speed (m/s) | | 0.5 | 1 | 1.5 | 2 | 2.5 | 3 |
| Code 128 – GS1-128 Code Resolution (mm) | 0.25 | 7 | 9 | 10 | 12 | 13 | 15 |
| | 0.30 | 8 | 9 | 11 | 12 | 14 | 15 |
| | 0.33 | 9 | 10 | 11 | 13 | 14 | 16 |
| | 0.38 | 10 | 11 | 12 | 14 | 15 | 17 |
| | 0.50 | 12 | 13 | 14 | 16 | 17 | 19 |
| | 0.72 | 16 | 17 | 18 | 19 | 21 | 22 |
| | 1.00 | 21 | 22 | 23 | 24 | 25 | 26 |

Table 3

| | | Minimum Code Height for ACR Reading (mm) | | | | | |
|------------------------------------|------|--|----|-----|----|-----|----|
| | | 45° | | | | | |
| Conveyor Speed (m/s) | | 0.5 | 1 | 1.5 | 2 | 2.5 | 3 |
| Codabar Code Resolution (mm) | 0.25 | 8 | 9 | 10 | 12 | 13 | 15 |
| | 0.30 | 9 | 9 | 11 | 12 | 14 | 15 |
| | 0.33 | 9 | 10 | 11 | 13 | 14 | 16 |
| | 0.38 | 10 | 11 | 12 | 14 | 15 | 17 |
| | 0.50 | 13 | 13 | 14 | 16 | 17 | 19 |
| | 0.72 | 17 | 18 | 18 | 19 | 21 | 22 |
| | 1.00 | 23 | 23 | 24 | 25 | 26 | 26 |

Ratio 3:1; Interdigit = Module Size

Table 4

| | | Minimum Code Height for ACR Reading (mm) | | | | | |
|--|------|--|----|-----|----|-----|----|
| | | 45° | | | | | |
| Conveyor Speed (m/s) | | 0.5 | 1 | 1.5 | 2 | 2.5 | 3 |
| EAN 8-13, UPC-A Code Resolution (mm) | 0.25 | 7 | 8 | 9 | 11 | 12 | 14 |
| | 0.30 | 8 | 9 | 10 | 11 | 13 | 14 |
| | 0.33 | 9 | 10 | 10 | 12 | 13 | 15 |
| | 0.38 | 10 | 11 | 11 | 12 | 14 | 15 |
| | 0.50 | 12 | 13 | 14 | 14 | 15 | 17 |
| | 0.72 | 16 | 17 | 18 | 18 | 19 | 20 |
| | 1.00 | 21 | 22 | 23 | 24 | 24 | 25 |

Table 5

5.11 READING DIAGRAMS

How to identify the scanner model:

The model type is shown on the serial label.



Figure 80 – Identifying the scanner model

- DX8210-2100 is two-laser, **Standard Resolution**
- DX8210-4100 is four-laser, **Standard Resolution**
- DX8210-4200 is four-laser, **High Resolution**

These reading diagrams were based on the following environment:

- 1000 scans per second (standard) throughout depth-of-field (DOF)
- ANSI Contrast Grade 84% or greater
- ANSI “Grade A” Print Quality
- Pitch not greater than +/- 15°
- Skew not greater than +/- 15°

DX8210-2100 0.25 mm/10 mil

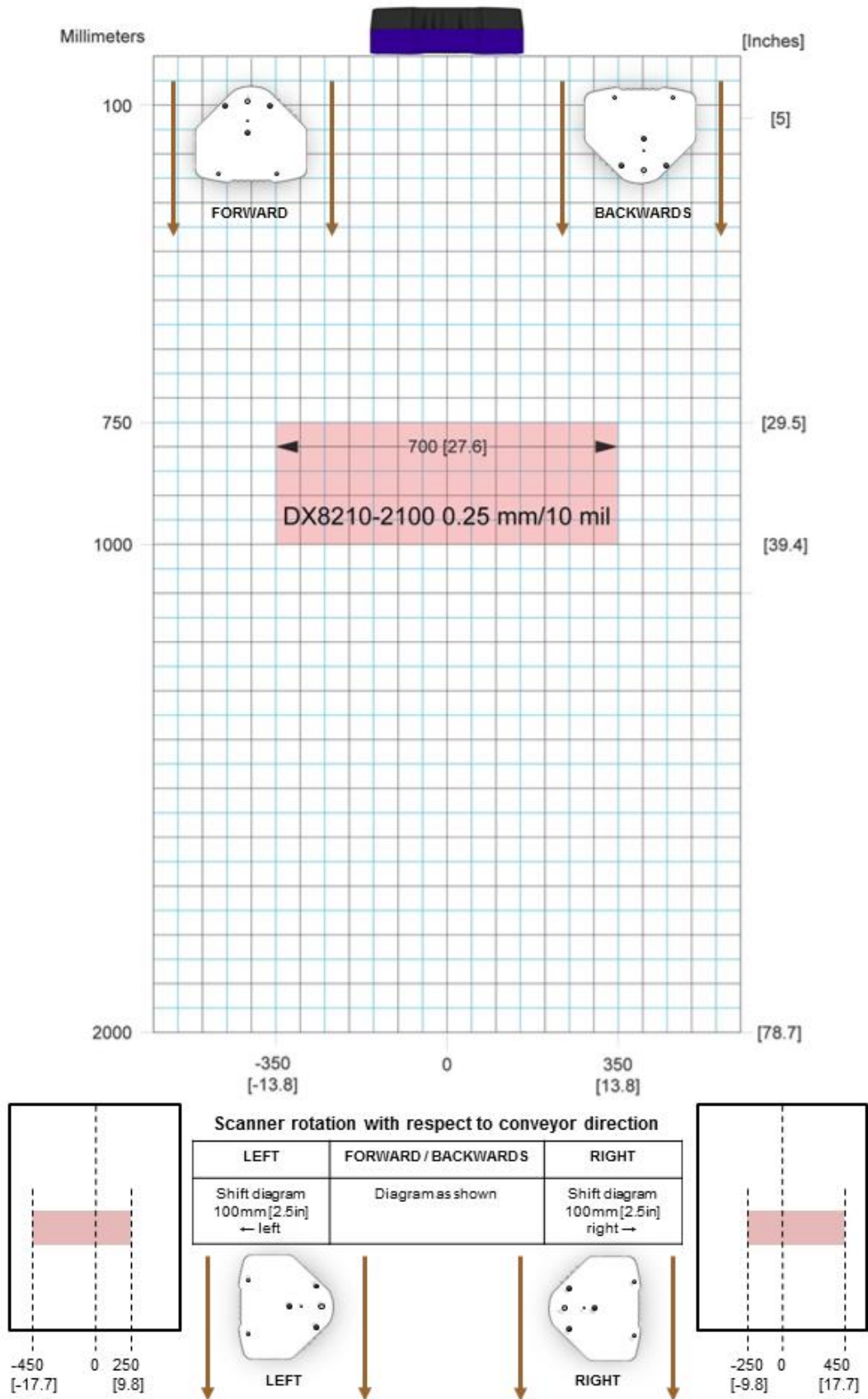

Figure 81 – Reading Diagram for DX8210-2100 0.25 mm/10 mil

DX8210-2100 0.30 mm/12 mil

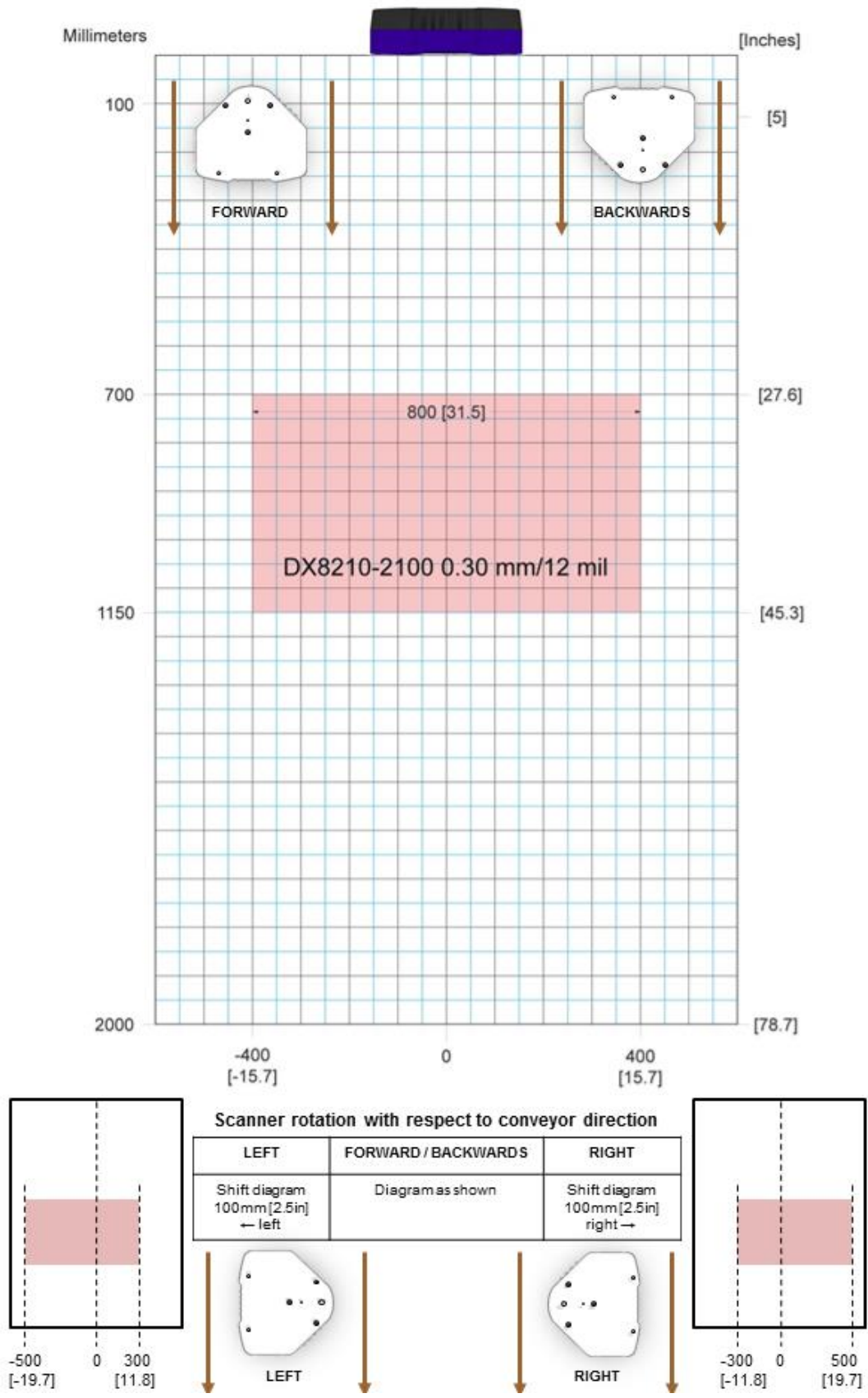

Figure 82 – Reading Diagram for DX8210-2100 0.30 mm/12 mil

DX8210-2100 0.38mm/15mil

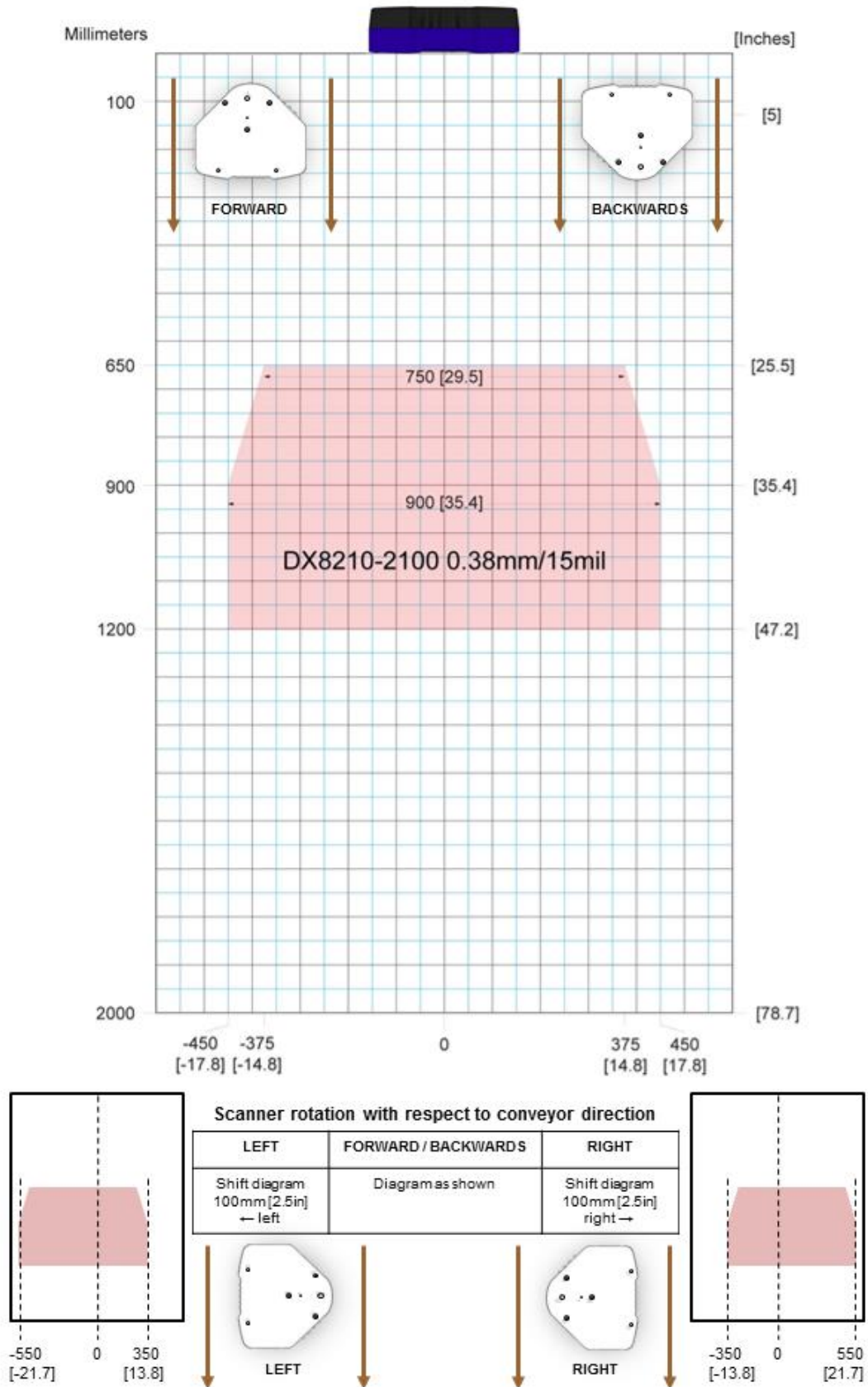

Figure 83 – Reading Diagram for DX8210-2100 0.38 mm/15 mil

DX8210-2100 0.50 mm/20 mil

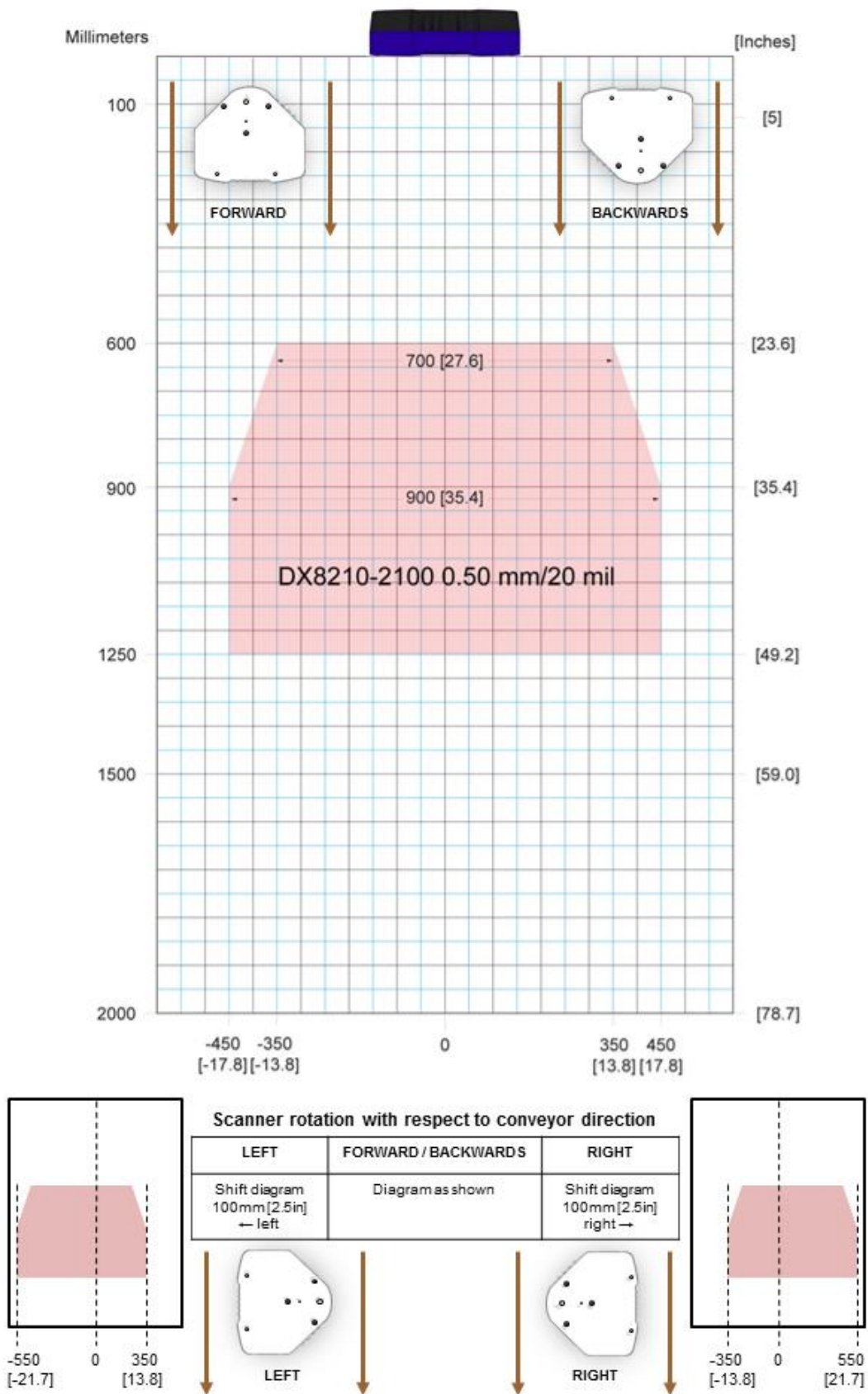

Figure 84 – Reading Diagram for DX8210-2100 0.50 mm/20 mil

DX8210-4100 0.38 mm/15 mil

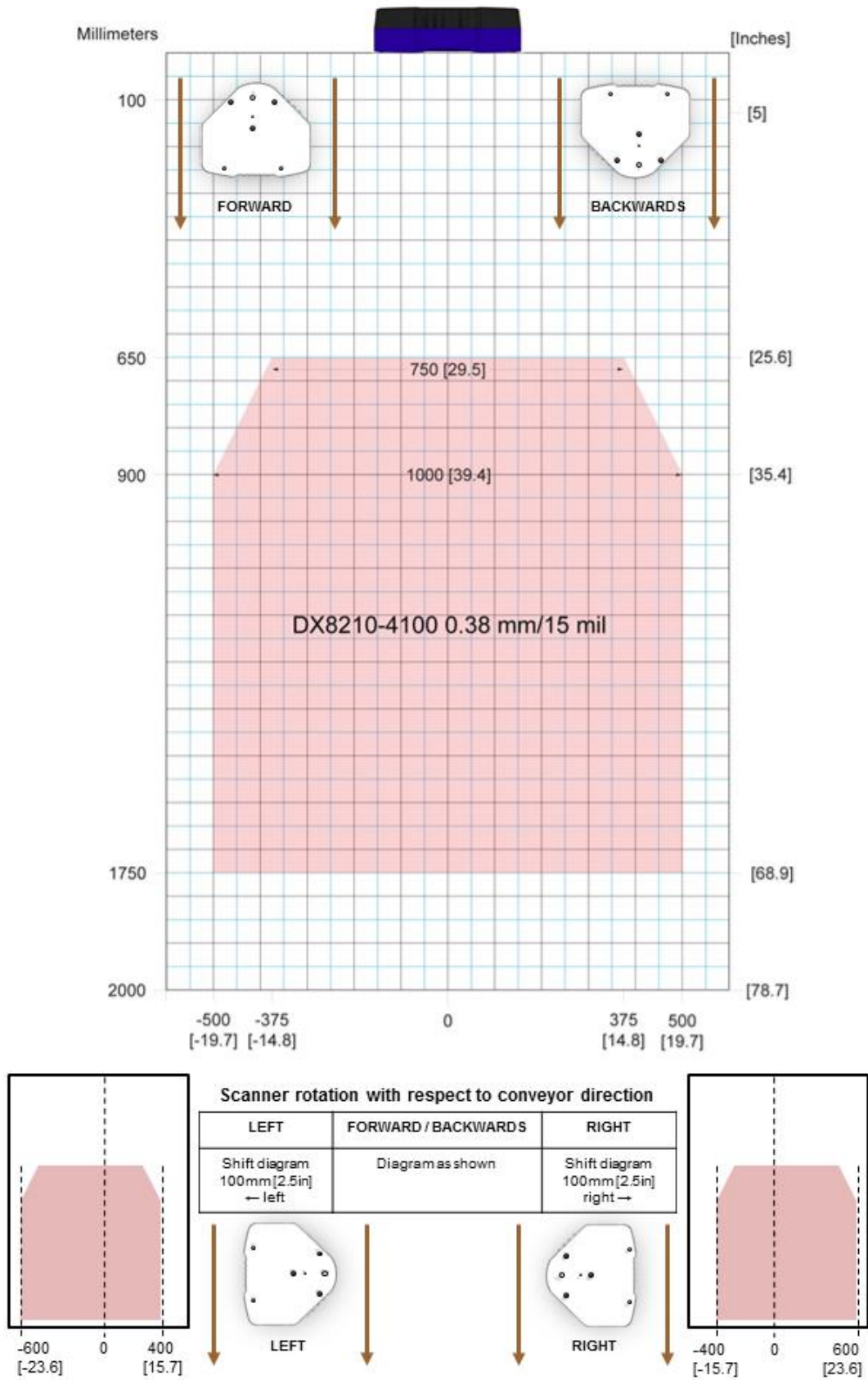

Figure 85 – Reading Diagram for DX8210-4100 0.38 mm/15 mil

DX8210-4100 0.50 mm/20 mil

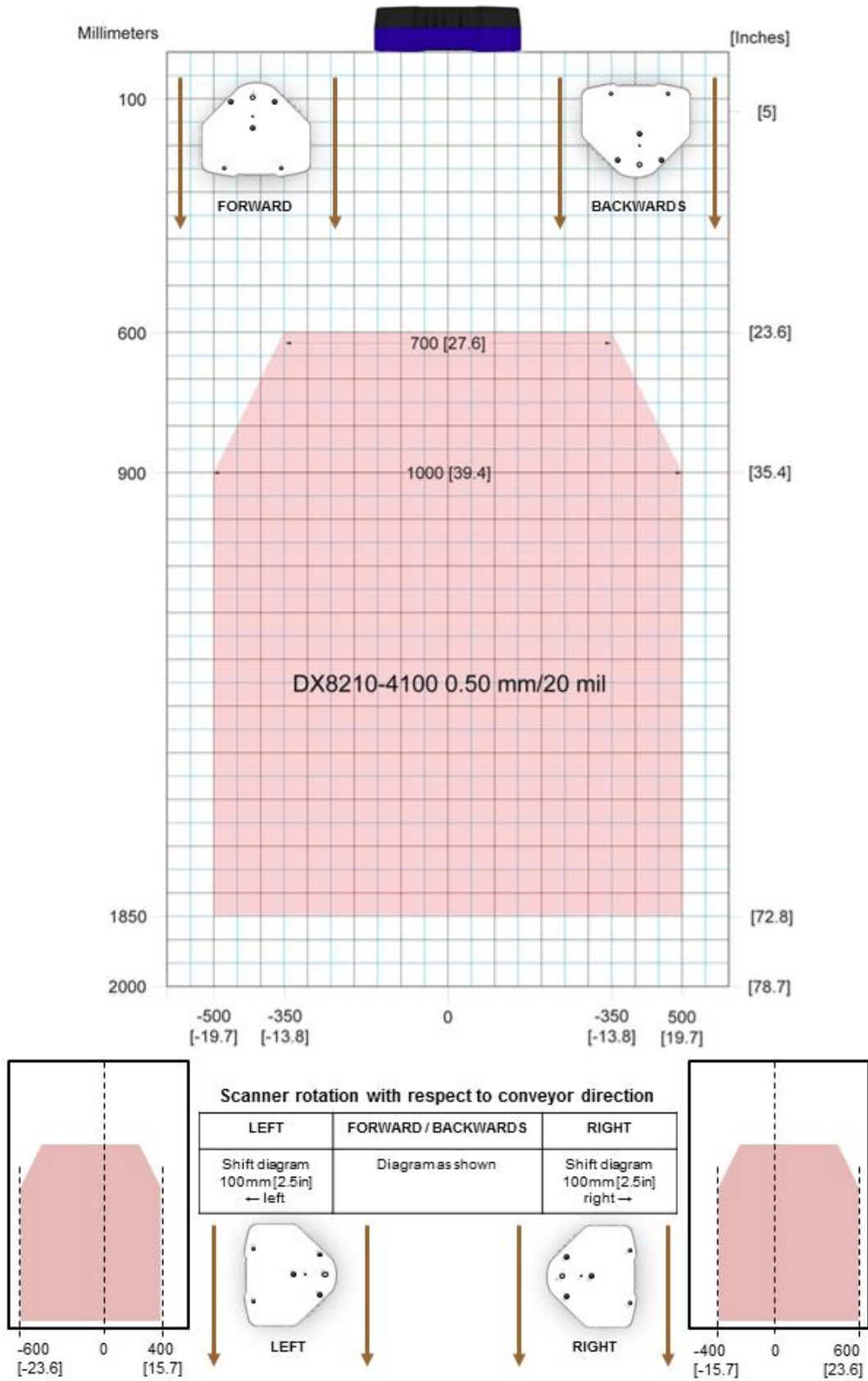

Figure 86 – Reading Diagram for DX8210-4100 0.50 mm/20 mil

DX8210-4200 0.25 mm/10 mil

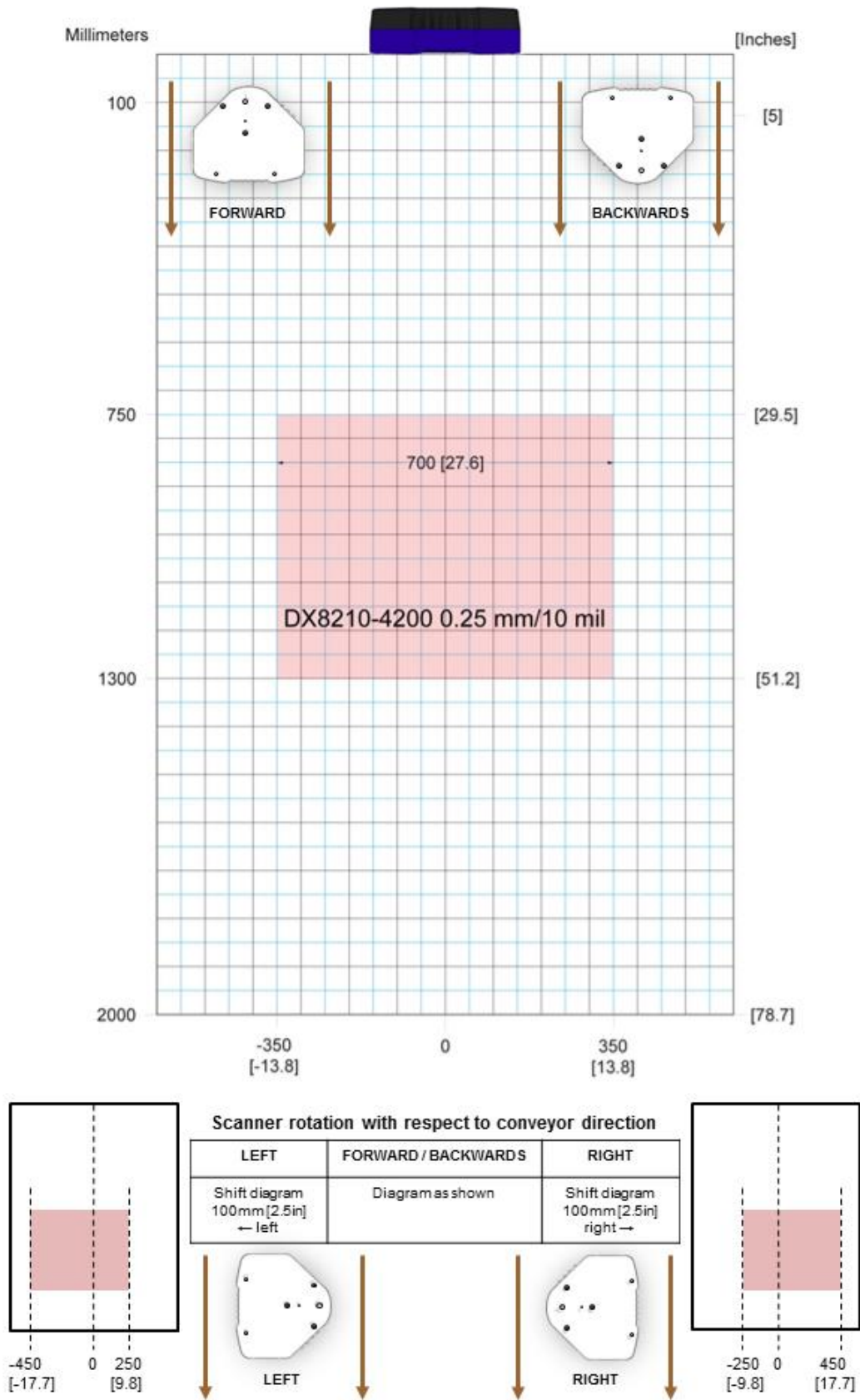

Figure 87 – Reading Diagram for DX8210-4200 0.25 mm/10 mil

DX8210-4200 0.30 mm/12 mil

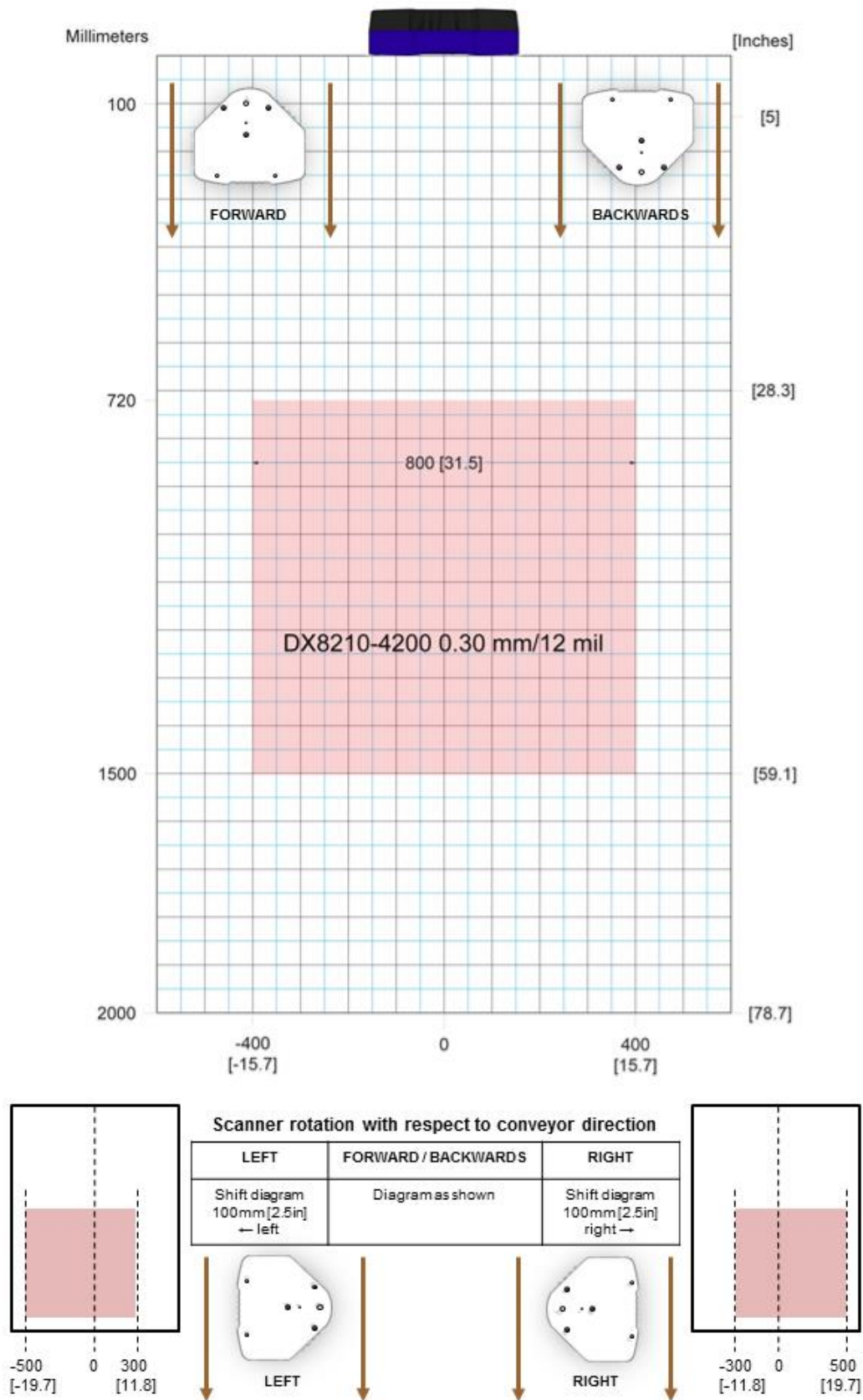

Figure 88 – Reading Diagram for DX8210-4200 0.30 mm/12 mil

6 MAINTENANCE

6.1 OVERVIEW

This chapter provides instructions for maintaining optimum performance and life for your DX8210 barcode scanners. It provides specific information on:

- Maintenance Procedures
- Exterior Cleaning
- Mounting Hardware Checks
- Wiring Connection Checks

| Item | Description |
|--------------------------------------|--|
| Soft-bristle brush | For cleaning the unit's exterior |
| Clean, soft cloths | For cleaning the unit's exterior |
| Cleaning solutions | Mild detergent solution for cleaning the unit's exterior. 70% denatured alcohol, 30% de-ionized water solution for cleaning exit window |
| Soft cotton swabs or lint-free cloth | Use to clean barcode scanner's exit window |



IMPORTANT: Due to the complex and application-specific nature of these installations, the barcode scanner must be setup and serviced by authorized technicians trained by Datalogic.

THE MAINTENANCE PROCEDURES IN THIS CHAPTER MAY BE PERFORMED BY AN END USER TECHNICIAN. Training is recommended if the end user intends to do more than the maintenance procedures provided in this chapter.

THERE ARE NO USER SERVICEABLE PARTS WITHIN THE BARCODE SCANNER.

DO NOT OPEN THE UNIT. Opening the barcode scanner may void its warranty.

CAUTION: Proceeding with any setup, calibration, or service procedures without proper training may void the warranty.

For further information on training, contact us through our website at www.datalogic.com.

6.2 MAINTENANCE TASKS

Perform the maintenance tasks on an “as needed” basis to assure proper operation of the barcode scanner. Task schedule frequency depends upon the application environment conditions. It only requires a few minutes to complete each maintenance task.

Exterior Cleaning



WARNING: Shut down the scanner before performing this maintenance task. Do not stare into the scanner’s exit window at the laser light. Avoid direct eye exposure. The laser light level does not constitute a health hazard, however staring at the laser light for prolonged periods could result in eye damage.



CAUTION: Do not use any chemical on the scanner that is unsafe for plastics, such as benzene, acetone, or similar products. Before performing this maintenance task, be sure to shutdown the unit.

The exterior cleaning procedure may be performed without removing the reader from the mounting structure.

1. Turn off the barcode scanner by disconnecting the power source.
2. Clean the exterior (except the exit window) with a clean, soft-bristle brush. Be sure not to brush any dust, dirt, or debris onto the exit window.
3. Carefully remove any debris in or around the exit window.
4. Wipe the exterior (except the exit window) with a clean, soft cloth dampened slightly with a mild detergent solution.
5. The exit window should be cleaned after this task is completed.

6.2.1 Cleaning the Exit Window



Figure 89: Exit window locations



WARNING: Shut down the scanner before performing this maintenance task. Do not stare into the scanner's exit window at the laser light. Avoid direct eye exposure. The laser light level does not constitute a health hazard, however staring at the laser light for prolonged periods could result in eye damage.



CAUTION: Never apply cleaning solution directly to the exit window. Always apply the solution to a cloth, and then the cloth to the window. Do not use any chemical on the barcode scanner that is unsafe for plastics, such as benzene, acetone, or similar products.

The exit window cleaning procedure may be performed without removing the reader from the mounting structure if it is possible to do so.

1. Turn off the scanner by disconnecting the power source.
2. Follow the exterior cleaning procedure before cleaning the exit window
3. Check the exit window surface for any dust, dirt, or smudges. If the window needs to be cleaned, proceed to Step 4.
4. Make a solution of seven parts denatured alcohol and three parts water.
5. Apply the cleaning solution to a cotton swab or lint-free cloth.
6. Apply the cleaning solution to the exit window.
7. Remove any streaks or remaining moisture from the exit window with a dry, soft, lint-free cloth or lens paper.
8. Verify scanner operation.

6.2.2 Cleaning the Photoelectric Sensor

If your application uses the photoelectric sensor option as a hardware trigger, be sure to clean the photoelectric sensor periodically as outlined below.

1. Turn off the product transport.
2. Turn off the scanner by disconnecting the power source.
3. Clean the photoelectric sensor's lens using the denatured alcohol solution and a cotton swab or lens paper.
4. Clean the reflector using the denatured alcohol solution and a cotton swab or lens paper.
5. Verify photoelectric sensor operation.

6.2.3 Cleaning the Tachometer/Encoder

If your application uses the tachometer option for tracking purposes, be sure to clean the tachometer wheels periodically as outlined below.

1. Turn off the product transport.
2. Turn off the scanner by disconnecting the power source.
3. Using a clean, soft cloth, wipe the wheels of the tachometer clean using a mild detergent solution.
4. Before restarting the system, be sure the tachometer is making good contact with the product transport.
5. Verify tachometer operation (see 6.2.8).



Figure 90: Tachometer Wheel

6.2.4 Tighten Mounting Hardware

1. Check all barcode scanner, CBX connection box (if applicable), SC5000 Controller (if applicable), and power supply mounting hardware. Tighten as necessary. Do not over-tighten. Be sure not to disturb the equipment's alignment as it relates to the product transport.
2. Check the mounting hardware of the Photoelectric Sensor (if this option is being used). Tighten as necessary. Do not over-tighten.
3. Check the mounting hardware of the tachometer (if this option is being used). Tighten as necessary. Do not over-tighten.

6.2.5 Checking Barcode Scanning System Connections

Wiring connections to the barcode scanners are made to the connector panel and CBX510 or SC5000 Controller. (See Chapter 3, *Electrical Installation*.)

1. Check all wiring connections to the connector panel. Tighten any loose connections as necessary. Do not over-tighten.
2. Check all wiring connections to the CBX510. Tighten any loose connections as necessary. Do not over-tighten.
3. Check all cabling/conduit for signs of wear/damage. Repair/replace any damaged cable connections as necessary.

6.2.6 Verify Barcode Scanner Operation

If after performing maintenance, the barcode scanning system continues to perform below the normal operations experienced with the system under normal daily conditions, contact Datalogic through our website at www.datalogic.com.

6.2.7 Verify Photoelectric Sensor Operation

1. Block the Photoelectric Sensor emitter beam to confirm it is aligned properly with the reflector.
2. Verify that the TRIGGER LED on barcode scanner lights YELLOW when photoelectric sensor beam is blocked.

If the photoelectric sensor's LED does not light, adjust the photoelectric sensor so that it is properly aligned with the reflector.

If the TRIGGER LED on the barcode scanner does not light when the photoelectric sensor's beam is blocked, check the cabling between the photoelectric sensor and CBX510 or SC5000 for damage.

6.2.8 Verify Tachometer/Encoder Operation

Rotate the tachometer wheel.

The **ENC/TACH** LED in the CBX510 or the **TACH** LED on the SC5000 should flash indicating the tachometer is operational. Also, you can view the belt speed by navigating to **Diagnostics | Monitor** in **e-Genius** (see section 4.7.1).

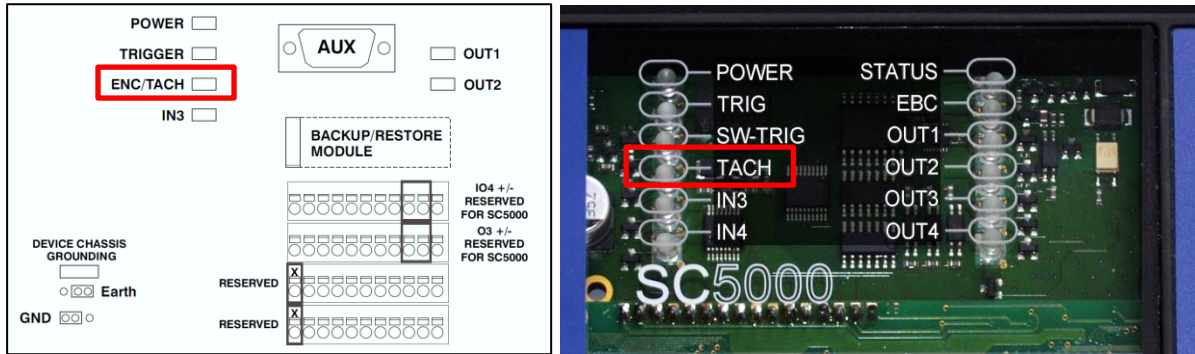

Figure 91: ENC/TACH LED indicators in CBX510 and SC5000

If these indicators do not register feedback when the tachometer wheel is rotated, check the cabling between the tachometer and the CBX510 for damage.

7 TROUBLESHOOTING



IMPORTANT: Due to the complex and application-specific nature of these installations, operational deficiencies of the barcode scanner must be diagnosed and serviced by a trained and authorized Datalogic technician.

There are no user serviceable components or field replaceable units (FRUs) inside the barcode scanner.

For further information on training, contact us through the Datalogic website at www.datalogic.com.



NOTE: When contacting Datalogic for help with a scanner, please be ready to share the unit serial number with the Datalogic technician. The unit's serial number tag is located on the device, where shown below. Help desk contact information is available at www.datalogic.com.



Figure 92: Serial Number Location

7.1 LED DIAGNOSTIC INDICATION

The **STATUS** and **READY** LEDs blink simultaneously to signal the presence of a failure. Diagnostic message transmission on interfaces can be enabled to provide details about specific failure conditions.

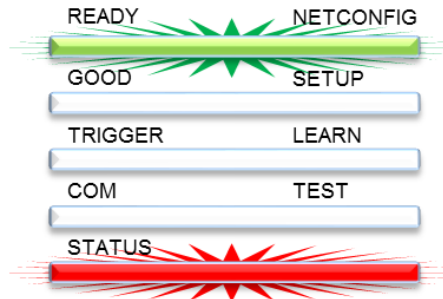
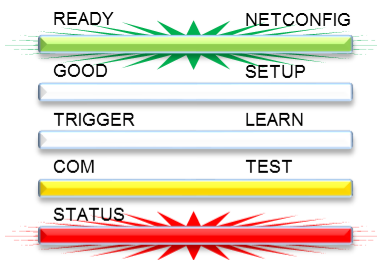
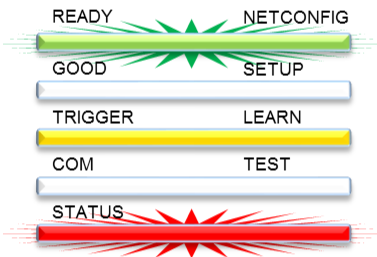

Figure 93: LED Failure Indication

At the same time one or more LEDs light up according to the following scheme:



STATUS/READY + COM = Laser Failure



STATUS/READY + TRIGGER = Motor Failure

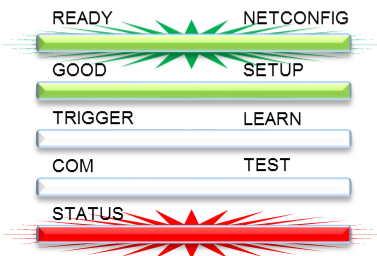

STATUS/READY + GOOD = Other Failure

Figure 94: LED Failure Specific Indication

In a **Master-Slave** configuration, all Slave scanner alarms and failures can also be indicated on the Master by turning on the Master's **GOOD** LED. This feature can be enabled by checking the **HMI Settings | LED Settings | Indicate Errors on Master** parameter.

7.2 ERROR CODES AND RESOLUTIONS

| Error Code | Description | Severity | Explanation | Symptom | Troubleshooting | Action required |
|------------|---------------------|----------|---|---|--|---|
| 1 | Node not responding | Error | In a Master/Slave configuration, the Master monitors the status of the Slaves in its network. If a slave unit fails to be identified, the Master will post this message. | <ul style="list-style-type: none"> - The scanning tunnel's no-read rate increases. - More than one slave unit may be shown as not responding. | <ul style="list-style-type: none"> - In a tunnel configuration, the cabling that connects the system into to a network must be intact or a scanner will be reported as not responding. - Make sure all the slave units are powered on. | <ul style="list-style-type: none"> - Make sure cables are connected. - Check scanners power source. - Replace scanner. |
| 80 | Node Reset | Error | In a Master/Slave configuration, the Master monitors the status of the Slaves in its network. If a Slave resets, it sends a reset message to the Master. The Master then posts this error condition on the diagnostic screen. | <ul style="list-style-type: none"> - The scanning tunnel's no-read rate may increase during the Slave scanner's reconnection. | <ul style="list-style-type: none"> - This condition is related to a slave scanner. Make sure the power source of the slave is not faulty. | <ul style="list-style-type: none"> - If condition persists, replace the scanner. |
| 81 | Motor Failure | Error | The scanner's mirror wheel motor has failed. | <ul style="list-style-type: none"> - The scanner will be powered up but will not emit laser light from its exit window. - The scanners motor will not be spinning. | <ul style="list-style-type: none"> - Hold your hand in front of the scanner to determine if the laser is on. | <p>This is an internal failure and is not field serviceable</p> <ul style="list-style-type: none"> - Replace scanner. |
| 83 | Laser Failure | Error | Scanner has a laser failure. | <ul style="list-style-type: none"> - There is no laser light emitted from the scanner - The mirror wheel motor may still be spinning, however, the motor speed may be out of range at which time the scanner will turn off the laser light. | <ul style="list-style-type: none"> - Hold your hand in front of the scanner to determine if the laser is on. | <p>This is an internal failure and is not field serviceable.</p> <ul style="list-style-type: none"> - Replace scanner. |

| Error Code | Description | Severity | Explanation | Symptom | Troubleshooting | Action required |
|------------|-----------------|----------|--|--|---|--|
| 130 | Encoder Timeout | Warning | <p>No encoder (tachometer) is detected in specified time. The Encoder signal provides the scanner with belt speed and other tracking information.</p> <p>This error will only occur when the scanner is in the PackTrack mode.</p> | <ul style="list-style-type: none"> - The scanner may experience an increase in no-reads. - The scanner may start missing the transmit point. | <ul style="list-style-type: none"> - Confirm that the belt is running. - Make sure the encoder (tachometer) wheel is making a firm contact with the conveyor. - Check the Global Settings Diagnostics Encoder Timeout setting to confirm that it is not set too low (<i>See section 4.5.9</i>). | <ul style="list-style-type: none"> - Adjust the encoder (tachometer) mounting. - Adjust the Encoder Timeout setting (<i>See section 4.5.9</i>). |
| 131 | Input 1 Failure | Error | <p>The Primary PS (photoelectric sensor) Input is stuck in the active state (PackTrack Mode).</p> | <ul style="list-style-type: none"> - The scanner will not go into trigger. - No data will be transmitted to the Host. | <ul style="list-style-type: none"> - Check the alignment of the photoelectric sensor. - Check the functionality of the photoelectric sensor. | <ul style="list-style-type: none"> - Realign the photoelectric sensor. - Replace the photoelectric sensor. |
| 132 | No Phase Error | Error | <p>No Phase "timeout" is exceeded (On-Line and PackTrack Mode).</p> <p>- Trigger must be identified within a specified time.</p> | | | |
| 133 | Input 2 Failure | Error | <p>Secondary PS (photoelectric sensor) Input Failure Stuck Active (PackTrack Mode).</p> | <ul style="list-style-type: none"> - The scanner will not go into trigger. - No data will be transmitted to the Host. | <ul style="list-style-type: none"> - Check the alignment of the photoelectric sensor. - Check the functionality of the photoelectric sensor. | <ul style="list-style-type: none"> - Realign the photoelectric sensor. - Replace the photoelectric sensor. |

| Error Code | Description | Severity | Explanation | Symptom | Troubleshooting | Action required |
|------------|-------------------------|----------|---|--|---|---|
| 135 | Encoder Failure | Error | Phase input (trigger source) is activated while encoder (tachometer) is stopped (PackTrack Mode). | <ul style="list-style-type: none"> - No data will be transmitted to the host. - Scanner(s) will not read any barcodes. - System receives trigger cycle when no encoder signal is present. | <ul style="list-style-type: none"> - Check Diagnostics Monitor to see if the scanner is reporting a conveyor speed (See section 4.7.1). - Make sure the encoder (tachometer) wheel is making a firm contact with the conveyor. | <ul style="list-style-type: none"> - Adjust, realign, or replace the encoder (tachometer). |
| 157 | SD Card Failure | Error | <p>SC5000 - SD card cannot be accessed. The SD card contains the backup files. It also contains a copy of the scanners application software.</p> <p>This failure is only in the SC5000.</p> | <ul style="list-style-type: none"> - Unit will not backup or restore the parameters. | <ul style="list-style-type: none"> Try to save the parameters from the SC5000 to the SD card (see <i>SC5000 System Controller Reference Manual</i>). | <ul style="list-style-type: none"> - Confirm that the SD card is seated properly in the SC5000. - Replace SD card (see <i>SC5000 System Controller Reference Manual</i>). |
| 169 | Main Serial Port Error | Error | Protocol Index message not received on Main Serial Port. | | | |
| 176 | Aux Serial Port Error | Error | Protocol Index message not received on Aux Serial Port. | | | |
| 178 | Ethernet Socket 1 Error | Error | Protocol Index message not received on User Socket 1. | | | |
| 179 | Ethernet Socket 2 Error | Error | Protocol Index message not received on User Socket 2. | | | |
| 180 | Ethernet Socket 3 Error | Error | Protocol Index message not received on User Socket 3. | | | |
| 181 | Ethernet Socket 4 Error | Error | Protocol Index message not received on User Socket 4. | | | |

| Error Code | Description | Severity | Explanation | Symptom | Troubleshooting | Action required |
|------------|-------------------------|----------|--|--|---|---|
| 182 | Ethernet Socket 5 Error | Error | Protocol Index message not received on User Socket 5. | | | |
| 183 | Ethernet Socket 6 Error | Error | Protocol Index message not received on User Socket 6. | | | |
| 191 | Fieldbus Mismatch | Error | Fieldbus module type does not match specified model. - Module selection incorrect compared to the actual module installed. | | | |
| 193 | Fieldbus Config Error | Error | Error configuring fieldbus module. | - Unable to communicate to the module. | - Confirm that the unit is not communicating to the host. - Confirm that the fieldbus parameters are configured properly (<i>see section 4.5.8</i>). | - Replace fieldbus module. |
| 195 | Fieldbus DHCP Error | Error | Profinet module had a DHCP error. | - Unable to acquire an IP address. | - Confirm that the unit is not communicating to the host. - Confirm that the fieldbus parameters are configured properly (<i>see section 4.5.8</i>). | - Replace fieldbus module. |
| 205 | APD Temperature Error | Error | APD Temperature sensor is not working. A fluctuation in the scanner's temperature can have an adverse effect on several internal functions of the scanner. The scanner monitors the temperature, and if it is erratic, this error is posted. | - The scanner may experience an increase in no-reads. - The scanner may start missing the transmit point. | 1. Cycle power on the scanner; 2. Wait until the unit has time to cool down. 3. Restart the scanner and monitor it to determine whether the error reoccurs. | This is an internal failure and is not field serviceable. - Replace scanner. |

| Error Code | Description | Severity | Explanation | Symptom | Troubleshooting | Action required |
|------------|----------------------|----------|--|--|---|---|
| 207 | In Beam Sensor Error | Error | The scanner has an in-the-beam sensor, which provides timing for the decoding of barcodes. The scanner monitors this signal, and posts this error if the signal is sporadic or missing. | - The scanner stops reading barcodes. | - Put the scanner in the test mode to test its ability to read the barcode (see section 4.7.2). | This is an internal failure and is not field serviceable. - Replace scanner. |
| 211 | PTP Error | Error | Cannot synchronize the internal clock using the PTP (precision time protocol) protocol. This clock sync pulse is generated by the controller unit. It is used to sync the read data of all the scanners in the network with the master unit. | LEDs flashing. | - Confirm that all the scanners are connected in the chain. - Use the scanner test mode to confirm that the scanner can statically reading a barcode (see section 4.7.2). - Position a barcode on a box so it faces the questionable scanner, and dynamically test the scanner. | - Replace faulty scanner. |
| 219 | Fieldbus Comm Error | Error | Cannot communicate with the fieldbus module. | - The host loses communication with the scanner. | - Confirm that the unit is not communicating with the Host. - Confirm that the fieldbus parameters are configured properly (see section 4.5.8). | - Replace fieldbus module. |

| Error Code | Description | Severity | Explanation | Symptom | Troubleshooting | Action required |
|------------|-------------------|----------|---|--|--|---|
| 220 | Network Ring Open | Error | When the SC5000 is used, the scanner internal network is connected in a chain configuration. If the SC5000 detects that network chain is not complete, it will post this error. | <ul style="list-style-type: none"> - The system experiences a higher no-read rate. - One or more scanners may not appear on the System Info page (<i>see section 4.4</i>). | <ul style="list-style-type: none"> - Confirm that all the scanners are connected in the chain. - Use the scanner test mode to confirm that the scanner can statically reading a barcode (<i>see section 4.7.2</i>). - Position a barcode on a box so it faces the questionable scanner, and dynamically test the scanner. | <ul style="list-style-type: none"> - Replace faulty scanner. |

8 TECHNICAL FEATURES

This chapter provides detailed specifications for the DX8210 Omnidirectional Barcode Scanning Systems. It provides specific information on:

- Electrical Features
- Optical Features
- Reading Features
- Physical Features
- Environmental Features
- X-PRESS Interface
- Software Features

8.1 TECHNICAL SPECIFICATIONS

| ELECTRICAL FEATURES | |
|--|--|
| Power | |
| Supply Voltage | 20-30VDC |
| Consumption | 1 – 0.7 A Max. (note: 1.3A max peak at motor start-up) 20 W typical |
| Distributable Current (through I/O connector) | 0.6 A Max. |
| Communication Interfaces | |
| Main RS232 | 1200 to 115200 bit/s |
| Main RS422 full-duplex | 1200 to 115200 bit/s |
| Auxiliary RS232 | 1200 to 115200 bit/s |
| Ethernet (x2) TCP/IP | 100 Mbit/s |
| EBC Internal Network | 100 Mbit/s |
| Fieldbus | Embedded: EtherNet/IP Supported through CBX510 connection box or SC5000 models: PROFINET-IO, PROFIBUS-DP |
| Inputs | 3 opto-coupled and polarity insensitive NPN/PNP digital inputs (5-30 Vdc) |
| Outputs | 2 opto-coupled software programmable NPN digital outputs |
| OPTICAL FEATURES | |
| Wavelength | 630 to 680 nm |
| Safety Class | Class 2 - EN60825-1; Class II – CDRH |
| Light Source | Visible laser diode |
| Laser Control | Security system to turn laser off in case of motor slow down |
| Optic Architecture / Technology | ASTRA™ |

READING FEATURES

| | |
|-----------------------|---|
| Scan Rate | Typ.:1000 scans/s/ Max. |
| Maximum Resolution | Min:0.25mm (10mils)/Max: 1.0mm (40mils) |
| Max. Reading Distance | See section 5.11 Reading Diagrams |
| Max. Reading Width | See section 5.11 Reading Diagrams |
| Max. Depth of Field | See section 5.11 Reading Diagrams |
| Scan Pattern Type | X-Pattern |

PHYSICAL FEATURES

| | |
|-------------|--|
| Dimensions | 381 x 328 x 92.5 mm [15 x 13 x 3.6 in] |
| Weight | 7.7 kg (17 lb) |
| Enclosure | Aluminum Alloy |
| Connections | I/O, POWER, ETH1, ETH2; Other connections through CBX510 |

ENVIRONMENTAL FEATURES

| | |
|---------------------------|--|
| Temperature | Operating: 0 to 50 °C (32 to 122 °F) Storage: -20 to 70 °C (-4 to 158 °F) |
| Relative Humidity | 10-90% non-condensing |
| Ambient light immunity | >30,000 LUX |
| Vibration Resistance ① | <ul style="list-style-type: none"> • SINE vibration as per EN60068-2-6 • 2-10Hz : 14mm / 13-55Hz : 1.5mm / 70-500Hz : 2g • 2h per axis / 3 axes |
| Shock Resistance | As per EN60068-2-27, 30g / 11ms / 3 times up and 3 times down on each axis / 3 axes |
| Protection Class | IP65 |

X-PRESS INTERFACE

| | |
|----------------|--|
| LED Indicators | Ready, Good, Trigger, Com, Status |
| Keypad | HMI Keypad for alternative configuration and test mode and Restore Factory Default |

SOFTWARE FEATURES**Readable Code Symbologies**

| | | |
|--|---|--|
| <ul style="list-style-type: none"> • Code 128 • Interleaved 2 of 5 • Code 39 (Standard) | <ul style="list-style-type: none"> • GS1-128 • Codabar • Code 93 | <ul style="list-style-type: none"> • EAN-8/13 - UPC-A/E (including Addon 2 and Addon 5) |
| Operating Mode | On Line, Continuous, PackTrack™, Test | |
| Configuration Methods | e-Genius multilanguage, browser-based, on board HTML web server interface X-PRESS™ HMI key functions | |
| Multilabel Reading | Up to 10 different symbologies during the same reading phase | |

| | |
|--------------------------------|---|
| Headers and Terminators | Up to 128-byte headers and 128-byte terminators |
| Code Reconstruction Technology | ACR™ |
| Parameter Storage | Non-volatile internal FLASH |

OTHER

| | |
|-----------------|--|
| Service Options | Installation services and on-site training |
| Warranty | 2-year limited, parts and labor |

① Product not installed on provided bracket.

GLOSSARY

ACR™

Each version of the base has the powerful code reconstruction technology (ACR G5). The new fifth generation ACR considerably increases the code reconstruction reading capability in the case of damaged or very tilted barcodes.

Aperture

Term used on the required CDRH warning labels to describe the laser exit window.

Barcode

A pattern of variable-width bars and spaces which represents numeric or alphanumeric data in machine-readable form. The general format of a barcode symbol consists of a leading margin, start character, data or message character, check character (if any), stop character, and trailing margin. Within this framework, each recognizable symbology uses its own unique format.

Barcode Label

A label that carries a barcode and can be affixed to an article.

Baud Rate

A unit used to measure communications speed or data transfer rate.

CDRH (Center for Devices and Radiological Health)

This organization (a service of the Food and Drug Administration) is responsible for the safety regulations governing acceptable limitations on electronic radiation from laser devices. Datalogic devices are in compliance with the CDRH regulations.

Code Positioning

Variation in code placement that affects the ability of a scanner to read a code. The terms Pitch, Skew, and Tilt deal with the angular variations of code positioning in the X, Y and Z axes. Variations in code placement affect the pulse width and therefore the decoding of the code. Pulse width is defined as a change from the leading edge of a bar or space to the trailing edge of a bar or space over time. Pulse width is also referred to as a transition. Tilt, pitch, and skew impact the pulse width of the code.

EEPROM

Electrically Erasable Programmable Read-Only Memory. An on-board non-volatile memory chip.

Full Duplex

Simultaneous, two-way, independent transmission in both directions.

Host

A computer that serves other terminals in a network, providing services such as network control, database access, special programs, supervisory programs, or programming languages.

Interface

A shared boundary defined by common physical interconnection characteristics, signal characteristics and meanings of interchanged signals.

LED (Light Emitting Diode)

A low power electronic device that can serve as a visible or near infrared light source when voltage is applied continuously or in pulses. It is commonly used as an indicator light and uses less power than an incandescent light bulb but more than a Liquid Crystal Display (LCD). LEDs have extremely long lifetimes when properly operated.

PackTrack

PackTrack is a Datalogic patented parcel tracking system which improves the reading features in omnidirectional stations. In particular, PackTrack manages 6-sided reading systems when it is impossible to detect the real position of the code on the parcel, thus overcoming the need for external accessories essential in traditional tracking systems.

Parameter

A value that you specify to a program. Typically parameters are set to configure a device to have particular operating characteristics.

Pitch

Rotation of a code pattern about the X-axis. The normal distance between center line or adjacent characters.

Position

The position of a scanner or light source in relation to the target of a receiving element.

Protocol

A formal set of conventions governing the formatting and relative timing of message exchange between two communicating systems.

Resolution

The narrowest element dimension which can be distinguished by a particular reading device or printed with a particular device or method.

RS232

Interface between data terminal equipment and data communication equipment employing serial binary data interchange.

RS422

Interface that specifies the electrical characteristics of generators and receivers for use in serial communications over longer distances than RS232.

Scanner

A device that examines a printed pattern (barcode) and either passes the uninterpreted data to a decoder or decodes the data and passes it onto the Host system.

Serial Port

An I/O port used to connect a scanner to your computer.

Signal

An impulse or fluctuating electrical quantity (i.e.: a voltage or current) the variations of which represent changes in information.

Skew

Rotation about the Y-axis. Rotational deviation from correct horizontal and vertical orientation; may apply to single character, line or entire encoded item.

Symbol

A combination of characters including start/stop and checksum characters, as required, that forms a complete scannable barcode.

Tilt

Rotation around the Z axis. Used to describe the position of the barcode with respect to the laser scan line.

Trigger Signal

A signal, typically provided by a photoelectric sensor or proximity switch, which informs the scanner of the presence of an object within its reading zone.

UPC

Acronym for Universal Product Code. The standard barcode type for retail food packaging in the United States.

Visible Laser Diode

A light source used in scanners to illuminate the barcode symbol. Generates visible red light at wavelengths between 630 and 680 nm.

INDEX

- Accessories, 5
- ACR™, 249
- Applications for DX8210, 1
- Backup, 181
- Barcode Configuration
 - Code Collection, 99
 - Logical Combination, 87
 - Single Label, 78
 - Standard Multi Label, 82
- Barcode Configuration, 77
- Barcode Scanner
 - Cleaning Exit Window, 264
 - Verifying Operation, 267
- Barcode Scanning Features, 187
- Barcode Settings Table, 72
- Block Diagrams
 - Typical Connections, 24
- Calibration
 - Top Mount Alternative, 201
- CBX Connection Box
 - Photoelectric Sensor, Connecting, 35
 - Tachometer Wiring, 38
- CBX Industrial Connection Box, 10
- CBX510
 - Installation with, 189
 - Verifying Tachometer/Encoder Operation, 268
- CBX510
 - Connecting Photoelectric Sensor, 35
 - Connections, 32
 - Relay Configuration, 42
 - Tachometer/Encoder Wiring, 38
- CE COMPLIANCE, x
- Compliance, viii
- COMPLIANCE, viii
- Connecting a DX8210, 23
- Connecting a PC to DX8210, 30
- Connections
 - Electrical, 24
- Control Panel Buttons, 197
- Conventions, viii
- CONVENTIONS, viii
- Description of DX8210, 1
- Device Settings
 - Device Info, 166
 - Mounting, 168
 - Options, 171
- Device Settings, 165
- Diagnostics
 - LEDs, 270
- Diagnostics, 156
- Diagnostics, 174
- Diagnostics
 - Monitor, 175
- Diagnostics
 - Read Test, 177
- Diagnostics
 - Status Viewer, 178
- Digital I/O, 153
- DX8210
 - Accessories, 5
 - Applications, 1
 - Compliance, viii
 - Connecting, 23
 - Connecting a PC, 30
 - Connector Panel, 29
 - Description, 1
 - Error Codes, 271
 - General View, xii
 - Layouts, 245
 - Maintenance, 262
 - Model Description, 3
 - Read Charts, 253
 - Reading Diagrams, 253
 - Replacing, 241
 - Specifications, 277
 - Technical Features, 277
 - Troubleshooting, 269
 - Versions, 3
- e-Genius
 - Basics, 50
 - Getting Help, 51
 - Getting Started, 47
 - Help, 51
 - Menu Tree, 50
- e-Genius, 47
- Electrical
 - disconnect device, readily accessible, 31
 - high-voltage precautions, 31
 - installation sequence recommended, 211
 - safety ground, 31
- Electrical Connections, 24
- Electrical Installation
 - Preparation, 22
- Electrical Installation, 22
- Electrical Installation Guidelines, 28
- ELECTRICAL SAFETY, viii
- Encoder
 - Cleaning, 266
- Encoder/Tachometer, 8
- Energy Saving, 158
- Error Codes and Resolutions, 271

- ESD CAUTION, viii
- Ethernet
 - Ethernet IP, 115
 - Line Settings, 109
 - User Sockets, 111
 - WebSentinel, 118
- Ethernet, 108
- FCC COMPLIANCE, xi
- Fieldbus, 119
- Global Settings, 57
- Glossary, 280
- Grounding, 45
- HIGH VOLTAGE CAUTION, viii
- HMI, 163
- Human Machine Interface, 4, 163, 197
- Installation
 - Electrical Guidelines, 28
 - Mechanical, 12
 - Preparing, 12
 - Preparing for Electrical, 22
- Installation
 - sequence recommended, 211
- Installation Sequence, 14
- Installation with CBX510, 189
- Installation with SC5000, 192
- Installation, Checking, 46
- Interfaces
 - Main, 33
- Interfaces
 - Main RS232, 33
- Interfaces
 - Main RS485 Full Duplex, 34
- Introduction, 1
- LASER CAUTION, viii
- LASER SAFETY, viii
- Layouts, Typical, 245
- LED Diagnostic Indication, 270
- LED Indicators, 196
- Maintenance, 262
- Maintenance Tasks, 263
- Mechanical Installation, 12, 16
- Messaging
 - Message Builder, 138
 - Message Format, 124
 - Pass Thru, 149
 - Protocol Index, 146
 - Statistics, 144
- Messaging, 124
- Model Description, 3
- Modify Settings, 53
- Monitor, 175
- Mounting Specifications, 209
- NOTES, viii
- Operating Mode, 58
- Packtrack Calibration Wizard, 209
- PackTrack Calibration Wizard, 170
- PackTrack Wizard, 209
- PATENTS, vii
- Performance, 251
- Photoelectric Sensor
 - Cleaning, 265
 - Verifying Operation, 267
- Photoelectric Sensor, 7
- Photoelectric Sensor
 - Connecting to CBX Connection Box, 35
- Photoelectric Sensor
 - PNP Output, Wiring, 37
- Photosensor, 7
- Power Connections, 31
- Power Connector Pin-Out, 30
- Power supply
 - disconnect device, readily accessible, 31
 - requirements, 31
- Read Test, 177
- Reading Diagrams, 253
- Reboot, 183
- References, vii
- Replacing a DX8210, 241
- Restore, 181
- SC5000
 - Verifying Tachometer/Encoder Operation, 268
- SC5000
 - Connections, 44
- SC5000 System Controller, 11
- SC5000, Installation with, 192
- Sensor
 - Photoelectric, 7
- Serial Ports
 - Aux Port, 106
 - Main Port, 104
- Serial Ports, 104
- Specifications, 277
- Standard Regulations, viii
- Startup
 - First Time, 187
- Status Viewer, 178
- System Info, 54
- Tachometer
 - Cleaning, 266
- Tachometer
 - NPN Output, Wiring, 38
 - PNP Output, Wiring, 40
 - Wiring, 38
- Tachometer/Encoder, 8
- Technical Features, 277
- Text Entry Tool, 50
- Trigger
 - LED status indicator, 35

Troubleshooting, 269
Typical Layouts, 245
UL LISTING, x
Unpacking, 13
Update Firmware, 184
User Interface, 47
Utilities, 181
Versions of DX8210, 3
Warning Labels, ix
WARNINGS or CAUTIONS, viii
WEBSITE, vii

Wiring
 Digital Output Configuraton, 42
 SC5000, 44
Wiring
 Photoelectric Sensor, 35
 safety ground, 31
 Tachometer, 38
X-Press, 4, 197
Your Application
 What You Need to Know, 15



 **DATALOGIC**

www.datalogic.com